

$$\begin{array}{r} 264 + 82 \\ \hline 346 \end{array}$$



DR. B.R AMBEDKAR OPEN UNIVERSITY
UNIVERSITY - LIBRARY



N18603

**Dr. B. R. AMBEDKAR
OPEN UNIVERSITY**

962FL1 M-18603

AUTHOR: ~~W.M.~~ Flinders Petrie
W.M.

TITLE: History of Egypt

**Dr. B. R. AMBEDKAR
OPEN UNIVERSITY
LIBRARY
HYDERABAD-500 033**



**Dr. B. R. AMBEDKAR OPEN UNIVERSITY
LIBRARY**

Call No. 962
FL1 Accession No. N-184

Author : Flinders' Speeris, W.M

Title : History of Egypt.

This book should be returned on or before the d
last marked below.

--	--	--	--

962
FLI

Dr. B. G. O. U. LIBRARY
Acc No. N-18603
Date 962
Call No. FLI

This History is comprised in Six Volumes:

- | | |
|---------------------------|-----------------------|
| Vol. I. Dynasties I.-XVI. | By W. M. F. PETRIE |
| Vol. II. ,, XVII.-XVIII. | By W. M. F. PETRIE |
| Vol. III. ,, XIX.-XXX. | By W. M. F. PETRIE |
| Vol. IV. Ptolemaic Egypt. | By J. P. MAHAFFY |
| Vol. V. Roman Egypt. | By J. G. MILNE |
| Vol. VI. Arabic Egypt. | By STANLEY LANE-POOLE |

Sixth Edition.

November 1907

PREFACE



THE aim in producing the present history has been to place in the hands of students a book of reference which shall suffice for all ordinary purposes; while stating the information in such a form that any person who is likely to read such a work may grasp a general view of the course of one of the oldest civilisations of the world. A history that merely states the facts on the writer's authority may do well enough for the general reader; but for the student such writing is almost useless, and references are essential. In these pages every fact and every object has at least one authority stated for it, except where it rests on the author's personal observation. But it has not been needful to give more than one reference, usually the most accessible or useful, on each fact. Those who want to read up all the literature on any detail, will naturally refer to Wiedemann's *Geschichte*, which is an index to the subject so invaluable that no one can do much without it. And though every writer since that work has appeared must naturally be indebted to its pages, if dealing with Egyptian history or monuments, yet the present work is based on an actual

examination of every accessible book that is here quoted.

This history, however, does not aim at being a bibliography of the subject; nor has it seemed desirable to bring in theories or views which appear to have passed away, and not to need present attention. While endeavouring to notice everything that a student should bear in mind on each period, yet more space has been given in proportion to new facts or new theories, *pro* and *con*, than to those which will be already familiar to persons who have read works on the subject. Similarly, in the illustrations, it has been sought to give such as are not commonly known, wherever it was suitable to do so. In this way this work is not only complete in itself, but may serve as a supplement, brought down to date, to the other histories that have appeared. It will be found to provide illustrations, later information, and more chronological discussion than exists in the present histories of Brugsch, Wiedemann, or Meyer.

In the matter of ¹⁸¹³chronology—the backbone of history—it is sought here to glean everything that can be noticed as to the internal history of each period. And on the still more difficult question of general chronology, an attempt has been made to give some main outline of it to assist the memory. Where dates are confessedly so uncertain, it may seem presumptuous to keep a running head-date to the pages; but yet it is better to thus assist the reader's ideas of the relative periods of different rulers, than to refuse any such help on the ground that it can only be approximate. In the last chapter the actual bases of our present chronology are fully stated; and it must always be remembered by the reader that the range of uncertainty may be about

a century in the earlier parts of this volume, diminishing perhaps to about a generation by the close of the volume. No greater accuracy than this is in the least professed in the numbers here assigned. But as their relation to one another over short periods is probably correct within a few years, it is needful to state them to the nearest year.

In the very vexed question of transliteration, a course has been followed which will probably not satisfy either of the extreme parties. The names are neither reduced to unpronounceable skeletons, nor are they dressed out in ornate vocalisation. The skeleton and comma system may be very well for purely philological purposes, but is a gratuitous obstacle to the reader who has not taken a preliminary course of such work ; while the following of Greek and Coptic vocalisation renders it difficult to trace the word in hieroglyphics. Hence a system has been adopted very near to that which is most familiar to the English reader in other books.

Throughout this work I have received continual help from my constant friend, Mr. F. Ll. Griffith, whose special knowledge of the language has provided many new translations of texts here quoted, and whose familiarity with the literature has often been of great service to me.

This volume is but the first of a series which is intended to embrace the whole history of Egypt down to modern times. It is expected that three volumes will treat of the period of the Pharaohs, one volume of the Ptolemies, one volume of the Roman age, and one volume of Arabic Egypt. So far as practicable, the same system will be maintained throughout, though by different writers ; and the aim of all will be to provide

a general history, with such fulness and precision as shall suffice for the use of students. The material is necessarily restricted here to the dynastic history; and there is no intention of including a history of art, civilisation, or literature, which would each require a volume as large as this.

NOTE TO REVISED EDITION, 1902.

THE printing of the fifth edition of this volume has given an opportunity of adding such new discoveries as have appeared during the last three years. In doing so it was thought better to avoid altering the paging or the numbering of illustrations, so far as possible, so as not to upset past references to the volume. The earlier history, which has been entirely developed since the last edition, is here rewritten, and new illustrations are provided; while for the later part short references are placed in a list of addenda prefixed. In this way it is possible to add new discoveries to each fresh printing; until, some time hence, a general recasting of the whole, with fresh numbering throughout, may be suitable.

Nov. 1902.

CONTENTS



CHAP	PAGE
PREFACE	v
LIST OF ILLUSTRATIONS	x
LIST OF ABBREVIATIONS	xiv
ADDENDA	xvii
I. THE KINGS TO THE END OF THE FIRST DYNASTY	1
II. SECOND AND THIRD DYNASTIES	23*
III. FOURTH DYNASTY	37
IV. FIFTH DYNASTY	68
V. SIXTH DYNASTY	86
VI. SEVENTH TO TENTH DYNASTIES	108
VII. ELEVENTH DYNASTY	123
VIII. TWELFTH DYNASTY	145
IX. THIRTEENTH AND FOURTEENTH DYNASTIES	200
X. THE HYKSOS	233
XI. NOTES ON CHRONOLOGY	248
INDEX	255

LIST OF ILLUSTRATIONS



FIG.	PAGE
1. Capture of towns, slate palette	4
2. Names of king Ka, on jar	5
3. Name of queen Ha, on jar	5
4. Stone vase inscription of Zeser	6
5. Sealing of Nar-mer	7
5A. Slate palette of Nar-mer	8
6. List of kings, Table of Abydos	11
6A. Portion of Turin papyrus	12
7. Ebony label of Mena	15
8. Ivory label of Zer	17
8A. Jewellery of queen of Zer	18
9. Stele of Zet	18*
9A. Seal of Zet	18*
10. Inscription of Merneit	19*
11. Den on a label	20
11A. Lid of seal box	20
12. Seal of Azab	21
12A. Inscription of Azab	21
13. Captive on ivory	22*
14. Granite statue No. 1, Memphis	24*
14A. <i>Ka</i> names on statue No. 1	24*
15. Inscription of Ra-neb erased by Neteren	25
16. Vase of Neteren, inscription	25*
17. Seal of Perabsen, Set-name	26
17A. Seal of Perabsen, Horus-name	26
17B. Seal of Perabsen, joint-name	26
18. Seal of Ka-ra	26*
19. Figure of Kha-sekhem	27
19A. Inscription of Kha-sekhem	27*
20. Bowl inscription of Kha-sekhemui	28*

LIST OF ILLUSTRATIONS

xi

FIG.	PAGE
21. Scarabs of Ra-nebka	30
22. Step pyramid of Saqqara	31
23. Vase lid of Sneferu (C. Mus.)	32
23A. Section of pyramid of Medum	32*
23B. Pyramid angle and mastaba angle	32*
23C. Pyramid temple of Medum	33*
23D. Upper part of statue of Mertitefs	34*
23E. Rahotep and Nefert (C. Mus.)	35
24. Alabaster of Nefersa (F. P. Coll.)	35*
24A. Seal of Kha-ba (F. P. Coll.)	36
24B. Seal of Sahu (F. P. Coll.)	36
25. Inscription of Shaaru	37*
26. Plaque of Khufu (F. P. Coll.)	38
27. The Nine Pyramids of Gizeh from the south	39
28. Rock tablet of Khufu, Wady Maghara	43
29. Names of Khafra from a statue	47
30. West side of granite temple, showing passage and causeway leading askew up to temple of second pyramid	49
31. Plan of granite temple. Scale $\frac{1}{100}$	50
32. The Sphinx, side view	52
33. Khafra. Diorite statue (G. Mus.)	54
34. Steatite cylinder of Menkaura. $\frac{1}{2}$ scale (F. P. Coll.)	55
35. Section of the pyramid of Menkaura	57
36. Statuette of Menkaura (G. Mus.)	62
37. Scarab of Menkaura, and restoration by Hatshepsut	62
38. Scarab of Shepseskaf (F. P. Coll.)	64
39. Cylinder of Userkaf (B. Mus.)	70
40. Cylinder of Sahura. $\frac{1}{2}$ scale (F. P. Coll.)	71
41. Cylinder of Neferarkara. $\frac{1}{2}$ scale	73
42. Scarab of Kakaa (B. Mus.)	74
43. Scarab of Shepseskara (G. Coll.)	74
44. Scarab of An (F. P. Coll.)	75
45. Statuette of Ra'en'user (G. Mus.)	77
46. Slab with figure of Menkauhor, found re-used in Serapeum (P. Mus.)	78
47. Scarab of Assa (F. P. Coll.)	79
48. Flint ink slab of Assa (F. P. Coll.)	80
49. Stele at Elephantine. Scale $\frac{1}{100}$	82
50. Section and plan of passages of the pyramid of Unas. Scale $\frac{1}{100}$	83
51. Alabaster jar lid of Teta. Scale $\frac{1}{2}$	87
52. Scarab of Pepy I. (M. Coll.)	89
53. Rubble walls and chips forming the mass of the pyramid of Pepy I. At the right is the top of the chamber masonry	91
54. Cylinder of Pepy I. (Tylor Coll.)	96
55. Alabaster vase of Merenra (Flor. Mus.)	97
56. Scarab of Merenra (F. P. Coll.)	101
57. Rosette of Pepy II. (G. Coll.)	101

FIG.	PAGE
58. Slab of Pepy II., Koptos	103
59. Types of scarabs of Pepy and following dynasties	103
60. Scarab of Nebkhara (H. Coll.)	106
61. Alabaster of Horneferhen. $\frac{1}{2}$ scale (F.P. Coll.)	106
62. Scarab of Neby (G. Coll.)	113
63. Earliest symmetrical scarabs (B. Mus.; F.P. Coll.)	113
64. Scarab of Raenka (P. Mus.)	113
65. Scarab of Khety (P. Mus.)	114
66. Copper-work, brazier of Khety (P. Mus.)	114
67. Wooden palette of Kameryra (P. Mus.)	115
68. Scarab of Maābra (G. Mus.)	116
69. Scarab of Skhanra (F. P. Coll.)	116
70. Scarab of Khausera (G. Coll.)	117
71. Scarab of Aahotepra (F.P. Coll.)	117
72. Scarab of Aa (G. Mus.)	117
73. Base of statue of Khyan, Bubastis (G. Mus.)	118
74. Cylinders and scarabs of Khyan	119
75. Scarab of Uazed (G. Coll.)	121
76. Scarab of Yapeqher (M. Coll.)	122
W. Scarab of Yaqebher	p. xix, note to 122
77. Prince Antef (part of stele, G. Mus.)	126
78. Coffin of Antef I. (P. Mus.)	127
79. Coffin of Antef II. (P. Mus.)	128
80. Pyramidion of Antef III. (B. Mus.)	129
81. Coffin of Antef III. (B. Mus.)	130
82. Scarab of Mentuhotep II. (P. Mus.)	131
83. Stele of Antef IV., Elephantine	133
84. Scarab of Antef V. (F. P. Coll.)	134
85. Slab with head of Antef V., Koptos	135
86. Scarab of Mentuhotep III. (B. Mus.)	138
87. Figures at Shut er Regal	139
88. Scarab of Sankhara (F.P. Coll.)	141
89. Scarab of Amenemhat I. (E. Coll.)	148
90. Head of Amenemhat I., red granite, Tanis	150
91. Slab of Amenemhat I., Koptos	152
92. Scarab of Usertesen I. (F.P. Coll.)	156
93. Bust of Usertesen I., black granite, Tanis	158
94. Road up to tomb of Ameny, Beni Hasan	159
95. Usertesen I., Abydos	161
96. Usertesen I., Koptos	162
97. Scarab of Amenemhat II. (G. Coll.)	164
98. Sarbut el Khadem	166
99. Cylinder of Usertesen II. (B. Mus.)	168
100. Pyramid of Illahun from the south	169
101. Section and plan of passages in pyramid of Illahun. Scale $\frac{1}{100}$	170
102. Chief and women of Aamu	178
103. Queen Nefert, Tanis	175
104. Scarab of Usertesen III. (P. Mus.)	176

FIG.		PAGE
105.	Inlaid pectoral made under Usertesen III., Dahshur	177
106.	View of Semneh	180
107.	Scarab of Amenemhat III.	184
108.	Head of Amenemhat III., from his statue at St. Petersburg	185
109.	Plan of passages in Hawara pyramid. Scale $\frac{1}{1000}$	186
110.	Alabaster altar of Ptah neferu, Hawara pyramid	188
111.	Two tablets of Amenemhat III., Wady Maghara	189
112.	Map of the ancient Lake Moeris in the Fayum basin. The shaded part is that reclaimed from the lake by Amenemhat III.	190
113.	Scarab of Amenemhat IV. (P. Mus.)	196
114.	Scarab of Sebekneferu (G. Coll.)	197
115.	Cylinder of Sebekneferu (B. Mus.)	197
116.	Cowroids of Sehotepabra (F.P. Coll.)	208
117.	Scarabs of Rasebekhotep (F.P. and H. Colls.)	208
118.	Cylinder of Sebekhotep I. (B. Mus.)	209
119.	Grey granite statue of Mermeshau, Tanis	210
120.	Scarab of Sebekhotep II. (G. Mus.)	210
121.	Stele of Sebekhotep II. Royal daughters adoring Min	211
122.	Scarab of Neferhotep (F.P. Coll.)	212
123.	} Black basalt statuette of Neferhotep (Bologna Mus.)	{ 213
124.		{ 214
125.	Scarab of Sebekhotep III. (F.P. Coll.)	215
126.	Red granite statue of Sebekhotep III., Tanis	216
127.	Grey granite colossus of Sebekhotep III., Island of Argo	216
128.	Scarab of Khakara (F.P. Coll.)	218
129.	Scarab of Sebekhotep IV. (G. Coll.)	218
130.	Scarab of Sebekhotep V. (G. Mus.)	219
131.	Scarab of Aaab (F.P. Coll.)	219
132.	Scarab of Merneferra (G. Mus.)	220
133.	Scarab of Merhoteptra (P. Mus.)	220
134.	Scarab of Nebmaatra (P. Mus.)	220
135.	Scarab of Nehesi (Brent Coll.)	221
136.	Basalt statuette of Sebekemsaf, Thebes (F.P. Coll.)	223
137.	Scarab of Upuatemsaf (H. Coll.)	225
138.	Cartouches of Khen'zer (P. Mus.)	226
139.	Scarab of Neferabra (T. Mus.)	229
140.	Black granite fish offerers, Tanis	237
141.	Black granite sphinx, Tanis	238
142.	} Granite head, Bubastis	{ 239
143.		{ 240
144.	Cartouche of Apepa I., Gebelen (G. Mus.)	241
145.	Scarabs of Apepa I.	242
146.	Black granite altar of Apepa II., Cairo (G. Mus.)	243
147.	Obelisk of Ra'aa'sch, Tanis	244
148.	Scarab of Dudumes (F.P. Coll.)	245
149.	Cylinders of Sebeqkara (F.P. Coll.)	245
150.	Rock marking, Silsileh	246
151.	Scarab of Rahotep (F.P. Coll.)	246

LIST OF ABBREVIATIONS

The following abbreviations are used to denote the works and the collections most frequently quoted. The distinction between pages and plates is sufficiently shown by the character of numerals employed.

A.	L'Anthropologie (Journal).
A.A.	1898	Amélineau Fouilles d'Abydos, 1898.
A.J.	Coll.	Alnwick Collection.
A.C.W.A.	.	Ayrton, Currelly, and Weigall, Abydos iii.
A.E.	L'Archéologie Egyptienne, Maspero.
A.R.	Archæological Report, Egypt Exploration Fund.
A.S.	Annales du Service.
Ash. Mus.	.	Ashmolean Museum, Oxford.
A.Z.	Zeitschrift Aeg. Sprache.
B.A.G.	Berlin Anthrop. Gesellsch.
B.C.	Berlin Museum Catalogue.
B.D.	Bissing, Denkmäler, Aegypt. Sculptur.
B.F.C.	Bissing, Fayencegefässe, Cairo Catalogue.
B.G.	Brugsch, Geographic.
B.H.	" History (English edition).
B. Mus.	.	British Museum.
B.N.	Borchardt, Grabdenkmal des Königs Ne-user-re.
B.R.	Brugsch, Recueil.
B.S.C.	Bissing, Steingefässe, Cairo Catalogue.
B.S.J.	Brugsch, Sieben Jahre der Hungersnoth.
B.T.	" Thesaurus.
Cam. Mus.	.	Cambridge, Fitzwilliam Museum.
C.E.	Chabas, Melanges Egn.
C.M.	Champollion, Monuments.
C. Mus.	Cairo Museum (formerly Ghizeh Museum).
C.N.	Champollion, Notices.
C.O.E.	Congrès Oriental, St. Etienne, 1878.
C.R.	Capart, Recueil.
D.G.	Davies, Deir el Gebrawi.
D.P.	" Ptah-hetep.
D.S.	" Sheikh Said.
E. Coll.	.	Edwards Collection.
E.G.	Ebers, Gozen zum Sinai.
F.H.	Fraser, Graffiti of Hat-nub.
F. Mus.	.	Florence Museum.
F.P. Coll.	.	Flinders Petrie Collection.
F.S.	Fraser, Scarabs (now in Munich).
G.A.	Garstang, Arabah.
G. Bh.	Griffith, Beni Hasan.
G. Coll.	.	Grant Collection.
G.H.	Golenischeff, Hammamat.
G.K.	Griffith, Kahun Papyri.
G.M.	Garstang, Mahasnah.
G. Mus.	.	Ghizeh Museum.
G.S.	Griffith, Siut.

G. J. L.	Gautier and Jequier, Fouilles de Licht.
H. Coll.	Hilton Price Collection.
J. A. I.	Jour. Anthrop. Inst.
L. A.	Lepsius, Auswahl.
L. D.	„ Denkmäler.
L. D. E.	„ Denkmäler, Ergänzungsband.
L. D. T.	„ Denkmäler, Text.
L. K.	„ Königsbuch.
L. L.	„ Letters (English edition).
Lb. D.	Lieblein, Dictionary of Names.
L. S.	Legrain, Statues de Rois, Cairo Catalogue.
L. S. A.	Lacau, Sarcophages Antrieurs, Cairo Catalogue.
M. A.	Mariette, Abydos Catalogue.
M. A. ii.	„ Abydos ii.
M. A. F.	Mission Archl. Franc.
M. A. P.	De Morgan, Age de la Pierre, 1896.
M. Coll.	Murch Collection.
M. D.	Monuments Divers.
M. P.	De Morgan, Ethnographie Prehistorique, 1897.
M. F. D.	„ Fouilles à Dahchour.
M. G.	Meyer, Geschichte.
M. G. Coll.	Macgregor Collection.
M. I.	De Morgan, Monuments et Inscriptions.
M. K.	Mariette, Karnak.
M. M.	„ Mastabas.
M. M. A.	MacIver and Mace, El Amrah and Abydos.
Ms. A.	Maspero, L'Archéol. Egn.
Ms. C.	„ Contes Pop.
Ms. G.	„ Guide Bulak.
Mus. E.	Musée Egyptien.
My. E.	Murray, Egypt.
N. A.	Naville, Ahnas.
N. B.	„ Bubastis.
N. Bh.	Newberry, Beni Hasan.
N. G.	Naville, Goshen.
N. S.	Newberry, Scarab-shaped Seals, Cairo Catalogue
P. Ab.	Petrie, Abydos.
P. Ab. ii.	„ Abydos ii.
P. D.	„ Dendereh.
P. D. H.	„ and Duncan, Hyksos and Israelite Cities.
P. D. P.	„ Diospolis Parva.
Pell. P.	Pellegrini, Iscrizione . . . di Palermo, 1896.
P. G. R.	Petrie, Gizeh, and Rifeh.
P. H.	„ Hawara.
P. I.	„ Illahun.
P. Ins.	Piehl, Inscriptions.
P. K.	Petrie, Kahun.
P. Kop.	„ Koptos.
P. M.	„ Medum.
-P. Mus.	Paris (Louvre) Muscum.
P. N.	Petrie, Nebesheh.

P.N.B.	.. .	Petrie, Naqada and Ballas.
P.P.	.. .	,, Pyramids.
P.R.	.. .	Pierret, Recueil Inscrip. Louvre.
P.R.T.	.. .	Petrie, Royal Tombs.
P.S.	.. .	,, Season 1887.
P. Sc.	.. .	,, Historical Scarabs.
P. Sin.	.. .	,, Researches in Sinai.
P.T. i. and ii.	.. .	,, Tanis, i. and ii.
Pr. M.	.. .	Prisse. Monuments.
Q.H.	.. .	Quibell, Hierakonpolis.
Q.K.	.. .	,, El Kab.
Q.R.	.. .	,, Ramesseum.
R.A.	.. .	De Rouge, Album.
R.C.	.. .	Revue Critique.
R.E.	.. .	De Rouge, Etudes Egn.
R.P.	.. .	Records of the Past.
R.S.D.	.. .	De Rouge, Six Dynasties.
Rec.	.. .	Récueil de Travaux Egyptn. (Journal).
S.A.	.. .	Schäfer, Altaegypt. Annalen.
S.B.A.	.. .	Soc. Bibl. Arch. Proc.
S.B.A.T.	.. .	,, Trans.
S. Cat. F.	.. .	Schiaparelli, Catalogue Florence.
S.S.A.	.. .	Schack-Schackenburg, Unterwiss. des K. Amenemhat.
S.T.	.. .	Schiaparelli, Tomba Herchuf.
V.S.	.. .	Valeriani and Segato, Atlante.
W.G.	.. .	Wiedemann, Geschichte.
W.G.S.	.. .	,, ,, Supplement.

The above works, and others, can be consulted in the Edwards Library, University College, London.

TRANSLITERATION

The transliteration used here is as follows:—

a or á		p		d	
		f		z soft	
a		m		(as in azure)	
a or á		n			
u		r		é is inserted between	
y		h		consonants for	
i		kh		speaking pur-	
b		k		poses. Sometimes	
		g		the vocalisation	
		q		shown by Greek	
		t		and Coptic forms	
		th		is retained where	
				it has become very	
				familiar.	

A D D E N D A

DOWN TO 1907



THE whole question of Egyptian chronology has been largely changed in the last few years; and as it has now been resolved into two definite views—the long and the short chronology—an outline is given here, pending some general agreement. Both views accept the datum of the heliacal rising of Sothis at a given month and day in the XIIth dynasty (A. Z. xxxvii, 89–103; S. B. A. xxii, 352); and that there is no error in this statement is shown independently by the season of working in Sinai, which agrees with the recorded month of working on two inscriptions (P. Sin. 169, 170). Thus in the XIIth dynasty the shifting calendar is pinned down to a fixed point in its cycle of 1460 years' revolution through the seasons. The question in debate is in which cycle the XIIth dynasty occurred; does it end at 1786 B. C. or 3246 B. C.? Or, as it is agreed the XVIIIth dynasty began in 1580, were there 206 or 1666 years between the XIIth and XVIIIth dynasties? The advocates of the short period claim that there are not enough monuments known to fill more than two centuries. Yet we have remains of at least seventeen kings of the XIIIth dynasty, and every year adds to their number, which on an average of 7 years each is 120 years. The Hyksos age is now fairly defined, and requires us to recognise at least ten important reigns, besides the probability of a large number more, and 150 years would be a low estimate

for what is already well known. And at least 10 years must be allowed in the XVIIth dynasty. Thus 280 years is covered by reigns which are evident, while we ignore the probability that we only know yet the minor part of the rulers in this very dark and confused period. To compress this into two centuries seems impossible. The advocates of the longer period consider that the evidence of changes in the art, the language, and the burial customs show that much more than two centuries had passed, and that this fully balances the supposed scantiness of monuments as historic material.

The striking fact is that if we look at Manetho strictly as given by Africanus, this interval between the XIIth and XVIIIth dynasties appears

by sums of dynasties as 1590 years,
by total of periods as 1649 or 1738 years,
and by the Sothis risings as 206 or 1666 years.

Thus Manetho—within the limits of corruption by copying—agrees exactly with the longer period. To accept the short period requires the entire rejection of Manetho, and of the Turin papyrus of kings, written just at the close of this period. Against these documents there is no evidence, but only a prepossession drawn from our extreme ignorance of the contemporary monuments. The question will be found stated fully in P. Sin. 163-180.

The resulting dates for the dynasties, as discussed there, are—

DYNASTY.	BEGAN B.C.	DYNASTY.	BEGAN B.C.
I	5510	X	3687
II	5247	XI	3502
III	4945	XII	3459
IV	4731	XIII	3246
V	4454	XIV	2793
VI	4206	XV	2533
VII	4003	XVI	2249
VIII	3933	XVII	1731
IX	3787	XVIII	1580

Page 3. For the re-statement of the historical grounds for Dynasty O, see S.B.A. xxvii, 279.

Page 8. NARMER. Palette republished in B.D. 2.

Page 13. MENA. Vase glazed with two colours, Abydos (P. Ab. ii, iv, v). Piece of tablet and a second tablet from Naqada (A.S. vi, 126).

Page 16. ZER. Tablet from Abydos (S.B.A. xxix, 72).

Page 18. ZET. Bowl from Abydos (P. Ab. ii, xiv). Large mastaba and surrounding graves at Gizeh (A.S. vi, 99; P.G.R. 2-6, II-VI).

Page 21. * SEMERKHET. Rock stele showing three figures of this king, Wady Maghara, Sinai (P. Sin. 41, 42).

Page 22. QA. Stele republished B.D. 1. Prophet of Qa, Semnefer (L.D. ii, 27, 29).

Page 24. * HOTEF-AHAUI or —SEKHEMUI. Sealings in passages under pyramid of Unas (A.S. iii, 187).

Page 25. RA-NEB. Similar sealings (A.S. iii, 188, 189). Possibly the same as Neferka, at the great tomb of Zowyet el Aryan (A.S. vii, 257).

Page 25. NETEREN. Sealings found in a private tomb at Gizeh (P.G.R. 7, VI, B).

Page 25. * PERABSEN built a fort at Abydos (A.C.W.A. iii, 4; IX).

Page 28. KHASEKHEMUI built the Shuneh fort at Abydos (A.C.W.A. iii, 3; IX).

Page 29. * SA-NEKHT. A stele from Sinai (Cairo Mus.; P. Sin. 43). Nebka, name at Abusir (Berl. Mus.; B.N. 79).

Page 32. SNEFERU. Pyramid mentioned at Dahshur (A.Z. xlii, 5). Steles at Wady Maghara, Sinai (P. Sin. 44). Hawk at Serabit, Sinai (P. Sin. 96, 122). Mentioned by Hatshepsut at Serabit (P. Sin. 84). Diorite lid (Cairo Mus.), see B.S.C. 14,686. Priests of Sneferu, Ka-res, and Kem-ked at Dahshur (A.S. iii, 202).

Page 34.* Mertitefs. Group and head, see C.R. iv, v.

Page 37.* SHAARU, see discussion on carving (S.B.A. xxv, 215; xxvi, 93).

Page 38. KHUFU. A block of red granite with his name was found at Tideh, 15 miles N.E. of Desuk (Rec. xvii, 100).

An alabaster statue from Saqqara is supposed to be of this king (Mus. E. 12).

Abydos. Ivory statuette portrait (P. Ab. ii, XIII, XIV).

An ancient copy of a statuette, Karnak (Rec. xxvii, 69; L.S. 42,002).

Page 42. Nefer-ked, priest of Khufu (S.B.A. xxvii, 34).

(Unknown) priest is Urarnas of Vth dyn. (D.S. vi).

Psemtek-menkh stele is published A.Z. xvii, 34; Rec. xxii, 173.

Page 46. A piece of a diorite bowl of Khufu was found at Hierakonpolis (Q.H. i, xviii, 6).

On the pyramids and statues of the IVth dynasty, see Borchardt in A.Z. xxxiv, 89; xxxvi, 1. These theories have been generally disproved since publication.

Earlier winged discs have been found on pottery of first dynasty (R.T. ii, lv a, 134-155).

Page 47. KHAFRA. Statue (Cairo Mus.; B.D. 9, 10).

KHAFRA, diorite statues figured in A.Z. xxxvi, 2-14.

KHAFRA, alabaster statue, *add* Mus. E. 8; A.Z. xxxvi, 17.

KHAFRA. Clay sealing (F.P. Coll.).

Cylinder of sandstone, Abusir (Berl. Mus.; B.N. 138). Cylinder (Paris Cab. Med.; N.S. viii, 10).

Sealing (?), Abydos (P. Ab. ii, xvi, 19). Scarabs (Al. Coll.; Mac. Coll.; N.S. ix, 4, 5).

Page 53. Nefermaat I and II, priests, Dahshur (A.S. iii, 203, 204). Psemtek-menkh stele (A.Z. xvii, 34; Rec. xxii, 173).

Page 55. MENKAURA. Diorite statue, *add* Mus. E. 9; A.Z. xxxvi, 17.

Cylinder with *ka* name (A.S. iv, 134); sealing (P. Ab. ii, xvi, 18). Scarab, scroll border (G. Coll.; N.S. ix, 9). Gave grant of land to priests of Hathor, tomb of Nuk-ankh at Tehneh (A.S. iii, 127).

Page 58. The glazed tiles of the Saqqara pyramid are certainly early. In general the early remains now known leave little or no ground for the theory of restorations.

Page 63. The cylinder is of Assa (F.P. Coll.).

Page 64. SHEPSESRAF. Clay sealing from Abydos, see P. Ab. i, lv.

SHEPSESRAF. *Sed heb* festival; in 1st year began pyramid (Palermo stone, S.A. 32).

For biography of Ptah'shepses, see R.E. ix, 79.

Page 69. On the royal titles, see P.R.T. i, 35, 36.

Page 70. A copper cylinder of USERKAF was found at El Kab (Q.K. xx). In 5th year, offerings of lands to the temples (Palermo, S.A. 34).

USERKAF, sealings at Abydos (P. Ab. ii, xiv, xvi, 20). Named in tomb of Nuk-ankh, Tehneh (A.S. iii. 126).

Page 71. Kahap, a priest of USERKAF, at Berlin (B.I. 44, 45).

SAHURA. Cylinder, see F.S. 12.

SAHURA. Stele at Wady Maghara, Sinai (P. Sin. 44, 45. Parts of naos from Abusir (Cairo Mus.); cylinders (Cam. Mus., N.S. v, 6; Joseph Coll., N.S. viii, 8; F.S. 12); sealings (P. Ab. ii, xvi, 21, 22). Statue dedicated by SENUSERT I at Karnak (L.S. 42,004). Sen'nefer, priest, Gizeh (S.B.A. xxvii, 32).

Page 73. SAHURA. Clay seal with *ka* name (F.P. Coll.). In 5th year, offerings to temples. 13th year, offerings from Punt. Reigned 12 years 9 months 6 days; agreeing to 12 years, months lost, in T.P.; or 13 years in Manetho. Interregnum, 17 days (Palermo, S.A. 38).

NEFERARKARA. Pyramid temple at Abusir (A.Z. xxxviii, 101). 1st, 9th, and 10th years offerings to temples (Palermo, S.A. 39-41).

NEFERARKARA. Abydos stele (P. Ab. ii, xiv; Rec. xxvi, 236); cylinder (W.S.B. xvi, 331).

Page 74. KAKAA. Obelisk mentioned named *Ra'tem'ab* (Rec. xvii, 113).

For "Quarry works" read "Quarry marks."

Omit in last line but one "as that king succeeds Nefer'ar'ka'ra and."

Page 75. RANUSER. Pyramid and temple (*in extenso* B.N.). Sinai, Wady Maghara tablet (P. Sin. 45). Statue of red granite, Karnak (L.S. 42,003). Granite statuette (see Mus. E. 10; A.Z. xxxvi, 17). Vase (P. Ab. ii, xiv). Sealing (P. Ab. ii, xvi, 19).

Page 76. Pyramid priest, Minankh (S.B.A. xxvii, 33).

RANUSER, priest of pyramid Kah'hef (C. Mus.; A.Z. xxxv, 120).

Akhethetep, *add* see D.P. ii, 12.

A *sed heb* feast was celebrated (B.N. 139). The queen seems to have been named . . . nub (B.N. 25, 109); and a daughter Nebti-kha-merer (B.N. 31).

Page 78. MENKAUHOR. An obelisk of this king, named Khut, is mentioned (Rec. xvii, 113).

MENKAUHOR. Alabaster statue, *add* Mus. E. ii; A.Z. xxxvi, 17).

Akhethotep, *add* D.P. ii, 12.

Rock tablet in Sinai (P. Sin. 45). Sealing at Abusir (B.N. 132). Pyramid priest, Minankh (S.B.A. xxvii, 33).

Page 79. ASSA. Base of seated figure (P. Ab. i, lv). ASSA. Cylinder of white metal with full titles is in F.P. Coll.

Akhethotep, *add* D.P. ii, 12.

Restored Abusir inscription (Berl. Mus.; B.N. 158).

Page 81. For Ptahhotep's proverbs, see Petrie, *Religion and Conscience*.

Page 82. UNAS. Alabaster vase and lid (Abbott Coll. ; L.D.T. i, 7).

UNAS. Pyramid inscriptions, see A.Z. xxxii, 3.

UNAS. Pyramid temple, see A.S. ii, 254.

Page 86. Years of king 4 in T.P., *read* 14 for 4.

Page 87. TETA. Abydos stele (P. Ab. ii, xvii).

TETA. A couchant ox carved in breccia, with the name of Teta on the base (B. Mus. 29,211), is apparently a forgery.

Teta, priest of pyramid, Khenu (A.Z. xxxviii, 107).

Page 89. ATY. Inscription of Ptah'en'kau is added to one of Apy. Maspero suggests that this building recorded was the unfinished Mastabat Fara'un at Saqqara (Rec. xvii, 56).

PEPY I. Rock inscription at El Kab (Rec. xxii, 64).

PEPY I. Vases and lid (Abbott Coll. ; L.D.T. i, 7).

PEPY I. *After* "Rock graffiti, Hat-nub," *add.*—

Dendera, block (Dümichen, Dendera, iv, a).

„ mentioned at (Düm. Dend. i).

„ offerings by Pepy represented at (Düm. Dend. ii).

PEPY I. Life-size copper statue of PEPY (B.D. 12, 13), and lesser one of his son, were found at Hierakonpolis, now in C. Mus. (Q.H. i, pls. xliv, xlv ; ii, pls. l to lvi ; B.D. 12, 13).

Inscriptions, Abydos (P. Ab. ii, xx). Glazed tablets (P. Ab. ii, XXI). Scarab (N.S. ix, 7). Two cylinders (B. Mus. ; N.S. v, 10, 11).

Page 91. PEPY I. Prince Mena, keeper of pyramid (P.D. iii).

Page 93. The inscription named of Tehuti'nekht is probably later.

The *sed heb* of PEPY is named on a stele (B.I. 45, 46).

Page 94. Una inscription published in photograph in Mus. E. 27, 28.

Page 95. Later discussion of chronology points to the transport by Una being at the fall of the Nile in the main stream, and therefore about 4100 B.C. (P. Sin. 174).

Page 96. PEPY I. Cylinder of blue stone with inscription similar to Fig. 54 (Nash Coll. ; S.B.A. xxi, 170).

PEPY I. A box, bears an inscription of the "*semer uati*, keeper of the casket of PEPY's *sed heb* festival" (B. Mus.).

Page 97. MERENRA. Canopic jars in C. Mus. (A.Z. xxxvii, 61).

MERENRA. Inscriptions at Abydos (P.A.G. i, liv).

Alabaster vase, C. Mus. (B.S.C. 18,694).

Page 98. MERENRA, priest of, in *graffito* at El Kab (S.B.A. xxi, facing 114).

MERENRA. Princes Mena and Adu I, keepers of pyramid (P.D. iii).

Page 99. MERENRA. Mentioned at Deir el Gebrawi (D.G. xxiii).

Page 101. PEPY II. Alabaster vase and lid (Abbott Coll. ; L.D.T. i, 6).

PEPY II. Calcite cylinder (not glass) in Murch Coll. (B. Mus.).

Lintel and stele, Abydos (P.Ab. ii, XIX); glazed tablets, Abydos (P. Ab. ii, XXI). *Sed heb* feast and restorations at Abusir (B.N. 159). Foot of alabaster dish (B.S.C. 18,556).

Page 102. Aba, prophet, *add* see D.G. vii, xviii.

Prince Adu I, priest of pyramid (P.D. v).

For letter of Herkhuf, see A.Z. xxxi, 65.

Page 103. These scarabs are really of king SHESHA, XVIth dynasty.

Page 106. HOR'NEFER'HEN is dealt with earlier as HOR'NEFER'SA, see Rec. xx, 72.

Page 112. On the VIIth-Xth dynasties, see Lieblein (Rec. xxi, 216).

Page 113. Neby scarab is now read as Ykb (Yakub); others are in F.S. 182; F.P. Coll.; P.D.P. xxvii, xli, 12.

Dudumes given on p. 245 should probably come about here (Rec. xx, 72).

Page 115. RA-UAH-KA, KHETY, a new king of this age, has funeral formulæ copied by error on a private coffin (Rec. xxiv, 90).

The coffin of Api'ankhu, a priest of the pyramid of KA'MERY'RA, is in the Berlin Museum (S.B.A. xiii, 524; Rec. xxiv, 91; L.S.A. 28,088).

Jasper weight of KHETY, Retabah (P.D.H. xxxii A, xxxiii, 4).

KA'MERY'RA, priest of, Saqqara (A.R. 1906, 24).

Pages 116-117. For the whole of those scarabs of the Hyksos age, see dynasties XV-XVI, below.

Page 123. On ANTEFS and MENTUHOTEPS, see Steindorff (A.Z. xxxiii, 77). He seeks to divide these kings between the XIth and XIIIth dynasties; but the ancient lists are entirely against this view. And see Sethe in A.Z. xlii, 131.

Page 126. Of the *Erpa* Antefaa, a granite statue was dedicated by USERTESEN I at Karnak (Rec. xxii, 64; L.S. 42,005).

A stele of prince Nekht, son of a *Heg* Antef, was found at Abydos (P. Ab. i, lv, lvi).

Page 127. A seated figure and box of MENTUHOTEP I was found in an unused tomb at Thebes (S.B.A. xxiii, 292; A.S. ii, 201).

Page 131. Two cartouches of a MENTUHOTEP occur in the cemetery at Dendera (P.D. xii).

Page 133. On the ANTEFAA IV stele, see also R.E. ix, 161, 162.

ANTEF IV stele at Karnak, see S.B.A. xxii, 77.

Page 134. Antefaqer, son of Mut, dates a stele in 33rd year of USERTESEN I, naming his great-grandfather as living under ANTEF IV (HOR-UAH-ANKH), implying about a century interval (A.Z. xxxiii, 77).

NUB-KHEPER'RA, statue, Karnak (A.S. v, 27). Stele, Abydos (P. Ab. ii, xxxii). Columns, Abydos (P. Ab. i, lv, lvi).

Page 135. ANTEF V built a temple of Osiris at Abydos, see columns in P. Ab. i, lv, lvi.

Page 137. The blocks seen by Harris are published in S.B.A. xxiv, 205, and probably join that published in P. Kop. vii, 14.

Page 138. NEB-HAP-RA. The reading *hap* in place of *kher* is proved by variants at Deir el Bahri. The great funereal temple and tomb there is described in recent years of *Archæological Report*. Named at Serabit (P. Sin. 97, 123). Blocks of temple at Abydos (P. Ab. xxiii-xxv). At Karnak a dedication of a statue by SENUSERT II and SEBEKHOTEP III (A.S. vii, 34). *Sed heb* figure (B.D. 19).

MENTUHOTEP III is adored by a man named Nefer-hotep (S.B.A. xxiii, 221).

Page 141. A statue of a MENTUHOTEP was found at Karnak (A.S. v, 28). Another king, MER'ANKH'RA MENTUHOTEP left a schist statuette at Karnak (Rec. xxvi, 221; L.S. 42,021).

SANKH'KA'RA. Statue at Karnak (A.S. v, 28; L.S. 42,006). Foundation deposit (P. Ab. ii, xxiii). Blocks, Abydos (P. Ab. ii, xxv). Personal name was MENTUHOTEP, by an altar from Abydos (S.B.A. xxvi, 75).

Page 148. AMENEMHAT I. Pyramid and temple, the northern at Lisht (G.J.L. *in extenso*). An altar, probably of this king, at Sebennytos (A.S. v, 124). Named at Serabit, in Sinai (P. Sin. 123).

AMENEMHAT I. A lintel was found at Medinet el Fayum (Rec. xi, 98); and blocks at Dendera (Düm. Dend. iii f, iv b). The queen is probably named Usertes-en-ankh (Sanehat).

Scarab found at Retabeh (P.D.H. xxxiii, 2).

Page 156. USERTESEN I. Pyramid *Kha* (L.D. ii, 135). Lisht, southern pyramid. Wall decorated with great *ka* name and personal name combined; ten colossal seated figures of Usertes-en, in limestone, finely wrought, lay on their sides in a court E. of the pyramid; six

statues of the king mummified as Osiris; great granite table of offerings in funereal chapel on the E. side; wooden cramps with name of Usertesen I; piece of ivory with name Nefru'ptah. All in Cairo Museum (Rev. Arch. xxix, 36; B.D. 19, 20; G.J.L.).

SEUSERT. The name has twice been found written as **SEUSERT** upon scarabs, like the spoken form **SEHOTEPABRA**, also found on scarabs. Hence there can be no doubt that this is the true form of the name, and that **USERTESEN** is an inverted form for writing. Heliopolis, jambs of doorway (A.S. iv, 101, 102). Serabit in Sinai, stele (P. Sin. 65, 97; group (P. Sin. 123). Abydos, block (P. Ab. i, LV, LVIII; blocks (P. Ab. ii, XXIII, XXVI); foundation deposits (P. Ab. ii, XXIII). Karnak, granite figure (Rec. xxiii, 63); building (A.S. iv, 12); sphinx (A.S. v, 29; L.S. 42,007); table of offerings (A.S. v, 29); group with Hathor (L.S. 42,008). Elephantine, pedestal, grey granite (A.S. viii, 37). Altar (L.D.T. ii, 89). Shells with cartouche, Rifeh (Nash. Coll.; S.B.A. xxi, 176; three in F.P. Coll.). Cylinder (Mac. Coll.; N.S. vi, 6). Wooden scarab from Nubt (P.N.B. lxxx, 3). Glazed vase (C. Mus.; B.F.C. front, and 3666). Named at Karnak on pylon by **RAMESSES X** (R.E. ix, 202).

Page 162. On the inscription of **MENTUHOTEP**, see Rec. x, 144, and R.E. ix, 303.

Page 163. **USERTESEN I.** Stele at Wady Halfa, completed, gives an account of Mentuhotep, who led an expedition to Nubia in the 18th year (S.B.A. xxiii, 230).

On **Khnem'nekht**, see P. Ins. iii, 1; on **Heruemhat**, P. Ins. iii, 19; and on **Antefaqer**, P. Ins. iii, 21; and A.Z. xxxiii, 77.

Page 164. Stele of **Mentu'nesu**, a general, see P. Ins. i, 1.

AMENEMHAT II. Serabit, stele (P. Sin. 60); figure of Hathur (P. Sin. 124). Mitraheny, block of granite (L.D.T. 203).

Page 167. Mentu'sa was born in the reign of AMENEMHAT I, and must therefore have been over 34.

A private stela of Kemsu is dated in the 12th year of AMENEMHAT II in the Kestner Coll., Hanover (Rec. xvii, 4).

Page 168. SENUSERT II. Serabit, base of statuette (P. Sin. 98). Karnak, statue(?) (L.S. 42,010); dedicated statue of MENTUHOTEP (A.S. vii, 34). Queen Nefert, statue in B.D. 21, 22.

A son of SENUSERT II, named Senusertsenb, and two daughters, Ataukayt and Nefert, are in the Kahun papyri (A.Z. xxxvii, 91). Of Ataukayt, a cylinder is known (M.G. Coll.; N.S. vi, 20).

Page 176. SENUSERT III. Temple and tomb at Abydos (A.C.W.A. iii, xxxvi-xliv; M.M.A. xx, xxi, 57-59). From the extreme care with which the granite sarcophagus was concealed in this enormous tomb it seems probable that it was the actual sepulchre, and the pyramid at Dahshur was only a cenotaph, surrounded by the royal family burials. At Serabit is a stela and a figure (P. Sin. 72, 98, 124). At Cairo was found part of a granite vase (B.S.C. 18,735). Abydos statues (P. Ab. ii, xxviii; and granite head (now recognised), A.C.W.A. xii). Ehnasya, a block (P.E. xi, xiv). Karnak, statues (L.S. 42,011-3); heads (Rec. xxviii, 138); figures (A.S. iv, 26); dedicated statue of MENTUHOTEP (A.S. vii, 34). Scarabs with Fu'ab'ra (?) (A.S. vi, 137). A stela of Sebek-khu from Abydos describes a war with south Syrians; he was born in 27th year of AMENEMHAT II, and lived to 9th year of AMENEMHAT III, 76 (G.A. iv, v, 32).

The publication of the pyramid sepulchres gives the names of two princesses, Ment and Meryt, and corrects the name of queen Henut'taui to Nefert-hent.

Page 179. Canal at Sehel found by Somers Clarke (A.Z. xxxii, 63).

Page 183. A piece of a stela shows a king (ending in *kau*, ? KHA'KAU'RA) and a queen Merseger, probably this queen (B. Mus. 846).

Page 184. AMENEMHAT III. Sinai, at Serabit the shrine of Hathor, was cut in the 2nd year by Khenemsu, possibly the same as Khenems, of whom there is a stele from Abydos in the 15th year (A.Z. xxxviii, 42). There are many steles of the mining expeditions at Serabit (P. Sin. 60, 66, 82, 83, 84, 98, 124; W.R.S.), and some at Maghara (P. Sin. 45, 46; W.R.S.). From Tanis is lion head (Berl. Mus.; B.N. 65). At Tell el Yehudiyeh was the base of a prince's statuette of this reign, and a cylinder (P.D.H. i. 7, 12). At Dahshur a pyramidion suggests that one of the pyramids was his (A.S. iii, 206). From Hawara is a seated figure (Cairo Mus.; B.D. 24). At Karnak a named statue (L.S. 42,014) suggests that several unnamed figures are likewise his. From Elephantine come the feet of a statue (A.S. viii, 48), and from Aswan a cylinder (A.S. iv. 73). Of the princess Ptah'neferu a piece of a sphinx is known (A.S. iv, 133). A strange cylinder names together AMENEMHAT, RA'NE'MAAT, AMENY, all with royal titles. It suggests that AMENY was a familiar form of AMENEMHAT (Mac. Coll.; N.S. vi, 19). In this reign is a stele of Senusertsenb Sebekhotep at Marseille (C.R. xxvii).

Page 190 (line 3). *Add* "dated in his 43rd year (VYSE, *Pyramids*, iii, 94).

Page 195 (line 2). Statue is from Memphis (B.R. 2). A block is at Copenhagen (P. Ins. i, 92; and see another, P. Ins. iii, 24).

A scarab of RA'EN'MAAT and RA'NEFER together is at Berlin. Also a plaque of RA'EN'MAAT, with a minute cartouche read as Hor, supposed to be Fu'ab'ra, but probably of XXVIth dynasty (A.Z. xxxiii, 143).

Pages 195-6. The joint cartouches of AMENEMHAT III and IV are on a stele, but without any date proving co-regency (B. Mus. 258).

Page 196. AMENEMHAT IV. Sinai, at Serabit he built the portico in front of the rock shrine (P. Sin. 93, 98). Steles at Serabit, see P. Sin. 63, 92. From Abukir

are the paws of a sphinx (Rec. xii, 213). A cylinder in Mac. Coll. (see N.S. vi, 18).

Page 200. An invasion of people akin to the prehistoric Egyptians has been dated, by excavations at Hu, to the close of the XIIth dynasty. Shallow panshaped graves, and bracelets of strips of shell threaded together, are their main characteristics (P.D.P. 45-49, xxxviii-xl). Similar pottery has also been found at Rifeh (P.G.R.), and appears to be usual in Nubia at about the same age.

Pages 200-205. The whole question of the Hyksos age has been reopened by the change in chronology, which shows that we must accept Manetho's dynasties as consecutive and nowhere contemporary. Also, by the discovery of their camp, and the arrangement of their remains, as described below, page 233.

Page 207. XIII, 1. RA'KHU'TAUI AMENEMHAT SEBEKHOTEP. Block with full name at Deir el Bahri, 1907. Cylinders (Davis Coll. ; N.S. xliii. 3 ; F. P. Coll.).

XIII, 2. RA'SEKHEM'KA. A stele is in the British Museum ; and a statue of his vizier Khenems is known (S.B.A. xxiii, 222) ; also a scarab (F.P. Coll.).

XIII, 4. RA'SEHOTEP'AB. An altar was found at Sebennytos (A.S. v, 124). This may perhaps be the same as RA'HOTEP'AB THENU'SI'HOR'NEZ'HER'TEF at Siut (Rec. xvi, 133 ; A.S. iii, 80).

XIII, 6. RA'SEANKH'AB. Scarab known (F.P. Coll.).

XIII, 9(?). RA'SESHES'KA AMENEMHATSENBEF is a king early in the XIIIth dynasty by the style of his cylinder, and may be the lost name, No. 9, ending in . . . ka (Am. Coll. ; N.S. vii, 3).

XIII, 13. RA'FU'AB or RA'AU'AB. The tomb of a king of this name was found in a pit on the south of the south brick pyramid of Dahshur. (See "Fouilles à Dahchour.") The tomb had been anciently rifled, but the ka statue in wood and its shrine, portions of the coffin, and the coffer of canopic jars remained, together with many of the smaller objects. The personal name of the king was HOR. The coffer of

canopic jars was still sealed up, and bore a clay impression reading RAENMAAT. A difference of opinion naturally exists in dealing with such contradictory facts. If the seal be held to prove that AMENEMHAT III sealed up the funeral objects, we then require to introduce HOR into the XIIth dynasty, and place him as a co-regent son of AMENEMHAT III, who died during his father's reign. The difficulty lies in supposing that such a person should altogether have escaped notice in the many monuments of that king which we know. On the other view, this king is the RA'AU'AB named in the Turin papyrus, 13th king of the XIIIth dynasty; but the seal has to be accounted for. It has been proposed that it was an old holy seal of the last great monarch still used by the priests, but that is not necessary. When we consider how famous AMENEMHAT III was, by the greatness of his works and the length of his reign, it would be very natural for later kings to take his name. That they did so is obvious in the XIIIth dynasty; the 3rd king is RA'AMEN'EM'HAT, the 6th is AMENY-ANTEF-AMENEMHAT, and two other kings took the name of AMENEMHAT I. We know so little about that age that it is far easier to grant an unknown king RA'EN'MAAT then, than to grant an unknown co-regent in the XIIth dynasty. The stele of the formulæ, which has been quoted as evidence, means nothing, as we do not know that they differ from those of the XIIIth dynasty. But the style of art—far more variable than formulæ—connects the wooden statue of HOR rather with the graceful SEBEK'HOTEP statues than with the more massive work of AMENEMHAT III.

The intact burial of a princess, Nubt'hotep, with her splendid jewellery, was found next to the tomb of HOR; but there is no evidence of her date.

The canopic jars of FU'AB'RA are in C. Mus. (M.F.D. 106; A.Z. xxxvii, 62), and pieces of gilt inscription in H.P. Coll. 3819. See L.S.A. 28, 106, 28, 107.

XIII, 15. RA'SEKHEM'KHU'TAUI SEBEKHOTEP I. A block at Karnak (A.S. v, 133), and a piece of a stele (A.S. vi, 133).

Probably near to this reign come two unplaced kings with similar names:—

RA·SEKHEM·KHU·TAUI PENTHEN, a stele found at Abydos (P. Ab. ii, xxxi), which looks as if it might be king 15 before he took the name of SEBEKHOTEP. He had a son Tahuti·aa who might perhaps be the following king:—

RA·SEKHEM·MEN·TAUI TAHUTI, on a door jamb found at Zowaydeh (P.N.B. xliii, 4), and on a box of a queen Mentuhotep at Berlin (A.Z. xxx, 45).

Page 210. XIII, 20. SEBEKHOTEP II. An inscribed lintel of SEBEKHOTEP II was found at Gebeleyn (Rec. xx, 72).

The name of SEBEKHOTEP can be traced on the early columns at Luxor (A.Z. xxxiv, 122).

Page 211. Queen Auhetab. A long stele with her relatives figured on it was found at Abydos (C. Mus. ; P. Ab. ii); and another scarab of her and SEBEKHOTEP II was found at Koptos (F.P. Coll.).

Page 212. For tomb of Sebek·nekht, see Tylor's volume on it, pl. vii.

XIII, 21. NEFERHOTEP I. A naos was found at Karnak (L.S. 42,022), and a large granite stele reappropriated at Abydos (M.M.A. xxix).

XIII, 23. SEBEKHOTEP III. At Abydos were two jambs of black granite (P. Ab. ii, xxviii), and a block (P. Ab. i, LIX). At Karnak a colossal statue (A.S. ii, 270), and two granite jambs (A.S. iv, 26). He dedicated a statue of MENTUHOTEP at Karnak (A.S. vii, 34). For the statue in Paris, see B.D. 28. A scarab was found at Lisht (G.J.L. 106). A block from Alexandria is probably of this king (B. Mus. 145). A glazed ring-stand is published (S.B.A. xxiii, 220). The vizier was Ankhu (A.Z. xxix, 104).

Page 216. The standing colossus is of later age; the figure of SEBEK·HOTEP III is seated.

Page 217. It is doubtful if *Hor sam tau* in this inscription is a king, and not rather the god.

Page 219. A stele of RA'UAH'AB, by the *Uartu* Si-hathor, is in B. Mus.

XIII, 26. Ay. Scarabs, from Lisht (G.J.L. 106), from Tell el Yehudiyeh (P.D.H., IVA, B. 4; and ix, 16).

XIII, 27. RA'MER'HOTEP SEBEKHOTEP (VIII). Granite statue at Karnak (Rec. xxvi, 219; L.S. 42,027).

XIII, 29. RA'MER'SEKHEM NEFERHOTEP (III). Two statues of block granite at Karnak (Rec. xxvi, 220; L.S. 42,023-4).

Page 221. RA'SNEFER'KA PEPEY, on a scarab of this age, or possibly earlier (F.P. Coll.).

RA'HOTEP'KA. On a cylinder of this age (F.P. Coll.).

A scarab of king NEHESI is now known (F.P. Coll.).

Page 222. SEBEKEMSAF. The canopic box and vase in the Leyden Museum are published in A.Z. xxxii, 23.

SEBEK'EM'SAF I. Piece of obelisk from Karnak (A.S. vi, 284; Rec. xxviii, 148, and a statuette (L.S. 42,029). For the statuette in F.P. Coll., see C.R. lxi.

Page 223. A limestone pyramid of a scribe Sebek-hotep has the cartouches of SEBEKEMSAUF II (B. Mus. 1163).

Page 225. MENTU'EM'SAF RA'DADUI'ANKH. A new king MENTU'EM'SAF, with throne-name RA'DAD'ANKH appear on a limestone slab from Gebelyn (Rec. xx, 72).

Scarabs (F.P. Coll. and Murch. Coll.; N.S. x, 25, 26).

Page 226. KHENZER had a vizier Ankh (see stele of Ameny-senb), of whom a cylinder is known (S.B.A. xxii, 64).

A joint scarab of KHENZER and USERKARA is in Munich (F.S. 65).

A new king RA? SEKHEM'NEFER'HOTEP appears on a fragment from Abydos (P. Ab. i, lix).

A stele of work like KHENZER's names RA'EN . . . ER'KA (L.D. ii, 150 f.).

Page 229. RA'SE'NEFER . . . may be RASNEFERAB, SENUSERT, of whom a colossal statue was found at Karnak (A.S. ii, 272, 281). (Rec. xxvi, 218; L.S. 42,026).

Page 230. Of SUA'ZEN'RA a dagger was found at Hu (P.D.P. xxxii), and two more scarabs are known (F.P. Coll.).

RA'SUAZ'EN SENBMAIU. Block with both names at Deir el Bahri, 1907. See pp. 230 and 246. A baton in Golenischeff Coll. (L.S.A. Index III).

Page 231. Other unnamed kings of this age are:—

RA'U'AQER, on a block at Abydos (P. Ab. ii, xxxii).

U'GAF, on the corner of a throne at Karnak (A.S. vi, 130).

RA'KA'SET, on a blue paste cylinder, perhaps modern (A.S. vi, 134).

Page 233. The age of the Hyksos has been lighted by the discovery of an immense earthen camp at Tell el Yehudiyeh (P.D.H. ii-iv), which shows that they were unacquainted with either stone or timber construction, and trusted to archery for defence. The position seems to agree with that of their chief camp of Avaris. After two or three generations they adopted stone walling around the camp, as described by Manetho. Graves of this age were found near and in the camp; and the connection of the styles of scarabs and of black incised pottery gave a basis for the classifying of the Hyksos scarabs by style (P.D.H. v-viii B, x, xii).

Probably just before the Hyksos invasion came adventurers from Babylonia, such as KHENZER (p. 226), a name which occurs later as a Babylonian king; and also KHANDY, of whom there is a jasper cylinder, showing a king in Egyptian dress, with cartouche, adored by a purely Babylonian figure, and the whole of Mesopotamian work of the Khammurabi age (F.P. Coll.). Also, a haematite scarab, reading KH'N'DU, NEB'TA, is doubtless of the same king (Blanchard, Cairo).

The order of the kings is given in a table, as classified by their style of scarabs, in D.P.H. (double vol.) 69, li. They are as follows, by Manetho and the scarabs:—

“Dynasty XV. Shepherds. Six foreign Phoenician kings, 284 years.”

MANETHO.	SCARABS.
SALATIS, 2533 B.C.	ANT-HER.
BEON.	SEM-GEN.
APAKHNAS.	?
STAAN (SIAAN, SHYAN). =	KHYAN.
ARKHLES.	YAQEB-HER, MER'USER'RA.
APOFIS.	APEPA SE'USER'RA.

“Dynasty XVI. Thirty-two Hellenic Shepherd kings, 518 years.”

MANETHO.	SCARABS.
SETHOS, 2249 B.C.	NEFER'KA'RA.
IANIAS.	NUB'KA'RA.
KERTOS.	KHEPER'RA.
	KA'RA.
	AA'NEB'RA.
	UAZED.
	SEKT.
	SAM'KA'RA.
	NEFERUI'UAH'RA.
	MAA'AB'RA (common).
ASSIS.	SHESHA (common).
	AAQ'ER (mu).
	KHA'USER'RA.
	SE'KHAN'RA.
	YAQEB'EL (mu).
	AA (mu).
	AA'HOTEP'RA.
	QAR.
	YKHA (mu).
	YA (mu).
	MAA'RA.
	NUBY'RA.
1731 B.C.	ER'DU'RA (mu).

The suffix title *mu*, or water, seems to show a connection with the sea. And these kings are called Hellenic by Manetho, that is doubtless Ha-nebu or Cypriote. They were then sea-kings with control of Cyprus and the Syrian coast.

Among these must be RA'NEB'KHEPESH APEPA, of whom a dagger with electrum handle (C. Mus ; A.S. vii, 115) was found in a coffin (L.S.A. 28, 108). Also a piece of flint vase (B. Mus. 4498 B).

Page 238. For the so-called Hyksos sphinx, see B.D. 25, 26.

Page 245. SE'BEK'KA'RA. Another cylinder is in Am. Coll. (N.S. vii, 6); and a scarab published (N.S. xliii, 9).

Page 247. A stele of PTAH'SE'ANKH, dated under RAHOTEP, is in B. Mus. (833). The work is very rude, and scarcely legible.

Page 250. Mahler has worked out the date of TAHUTMES III (A.Z. xxvii, 97), but has been recently corrected a few years by Lehmann, who points out that visible new moons, and not absolute new moons, were observed. Mahler's later paper on the Ramesside dates by the star diagrams in tombs (A.Z. xxxii, 99) gives results which cannot be reconciled with his THOTHMES III date, except by regarding them as horoscopes of the nativity of the kings, which is doubtless the correct view.

A HISTORY OF EGYPT



CHAPTER I

THE KINGS TO THE END OF THE FIRST DYNASTY

DURING recent years the knowledge of the early history and prehistoric age of Egypt has so greatly increased, that it is no longer possible to treat it as an introductory outline before the account of the well-known ages. It is not intended, therefore, to attempt to deal in this volume with any of the periods that lie before the continuous written record of the historic times. A whole volume is needful to deal suitably with the earlier civilisation of Egypt, and that I hope to prepare before long.

The statement of the earliest times that can be deemed historic, after the lists of gods and demi-gods, is in the opening of Manetho's history (as restored from Eusebius by Lepsius), where it is said that ten kings of Thisis reigned for three hundred and fifty years before Menes. Why the numbered dynasties should begin from Menes, and not from these earlier kings, is obvious when we remember that Manetho was a priest of Sebennytos in the Delta, and naturally began his history with the founder of Memphis, the first ruler of a united Egypt. Moreover, the earlier edition of the history engraved by Sety I on his temple at Abydos likewise begins from Menes; probably because the papyrus records, from which it certainly was compiled,

belonged to the old Memphite kingdom, which naturally started from Menes.

To suppose that the civilisation that we find under Menes started full-blown at that age, or to suppose that the dynastic conquerors of Egypt had no rulers before their acquisition of the whole country, is necessarily absurd. Before a king of Thinis-Abydos (from which Menes came) could possibly proceed to establish a new capital for the lower country at Memphis, the way must have been prepared by a long series of predecessors conquering and consolidating their power. That such a course of organisation occupied three or four centuries is highly probable: the Saxons took four centuries to form a united kingdom in England, and the Romans about the same length of time to acquire their dominion in Italy.

At Abydos have been found several tombs in the royal cemetery which appear to be older than the tomb of Aha-Menes. The reasons for attributing these tombs to this early age are—

(1) Their position on the desert, in advance of the tombs of the 1st dynasty.

(2) Their form, as simple as, or simpler than, that of the tomb of Menes.

(3) Their contents of sealings, ebony and ivory tablets, vases, etc., as early as, or earlier than, the style of those of Menes.

(4) The names of the kings being without the vulture and uræus title, but only with *nebu*. 𓏏

(5) The eight names of recorded kings of the 1st dynasty being already filled up with kings, whose works are obviously later than those of this earliest group.

The evidence for the relative ages of these earlier tombs is not so clear as that for the general period of the whole group, but must be drawn from minor details of their position and style.

Of the ten kings which are recorded by the earliest fragment of transmitted history, five names have been found among the royal tombs of Abydos; and these

names are probably, therefore, to be assigned to the sixth to tenth kings of the series, which we must designate as dynasty O.

DYNASTY O.		
KA NAME.	PERSONAL NAME.	B.C. about.
6 Ka	Ap	4940
7 Ro		4910
8 Zeser		4880
9 Nar	Mer	4840
10 Sma		4790
		4777

No names have yet been found that can be attributed to the earlier kings of this dynasty: yet the free writing of the titles and names of king Ka shows that the hieroglyphic system was quite familiarly used, and therefore that we may well expect to yet find some of the earlier names.

The condition of the country at the invasion of the dynastic people was that of a decadent civilisation of the prehistoric age; the highest development of that earlier time had taken place perhaps a thousand years before, and several different races had pressed into the country as the earlier inhabitants became enfeebled. On the earliest sculptures there have been traced five different races older than the dynastic people. (1) The old aquiline race of the Libyo-Amorite type, to which belongs the bulk of the prehistoric remains. (2) A people with curly hair and plaited beards, most like a type found later in the Hittite region. (3) A people with pointed nose and long pigtail of hair, who probably lived in the mountains by the Red Sea, as they wore long warm robes, and bring stone vases as tribute. (4) A people with short and tilted nose, who seem to have occupied Middle Egypt. (5) A somewhat similar

people, with rather longer nose and a projecting beard, who may belong to the Delta (see J.A.I. xxxi, pls. xviii-xx). Upon all these came in (6) an entirely different race, having a straight bridge to the nose, and a very vigorous and capable type of face. This race, starting from Upper Egypt, gradually dominated the country, and sealed its conquest by the founding of Memphis under Menes. Whence this dynastic race



FIG. 1.—Capture of towns, slate palette.

came can only be guessed from their first being established in Upper Egypt at Abydos; this points to their having entered the country from the Red Sea, across the desert at Koptos. To trace their origin further must be a matter of speculation, until research has opened up the history of the Red Sea region.

The conquest of Middle Egypt by the allied people of the upper country is figured in several forms on the early sculptures upon slate palettes. One of the most unmistakable is a fragment bearing seven figures of fortified towns (Fig. 1) which are being destroyed by the animals which were the ensigns of the tribes, using

. 5. 2. }
 16

كامل، يداود

a hoe to pick the walls to pieces. It seems probable that the towns of the upper row are in Middle Egypt, and those in the lower row belong to the Delta, while the conquering animals are the ensigns of the allied troops of Upper Egypt (see S.B.A. 1900, 140). Several other slate palettes have been found, nearly all of which are published in S.B.A. 1900, 125.

O. 6. KA-AP



about 4940-4910 B.C.

Tomb at Abydos (P.R.T. ii, 7, pls. lviii, lix).

Inscriptions on vases (P.Ab. i, pls. i-iii; P.R.T. ii, xiii).

Sealing (P.R.T. ii, xiii, 89).

Queen—HA (P.Ab. i, pl. iii).

The tomb of this king is a brick-lined pit about twenty feet long and half as wide. It had been entirely plundered anciently; but many cylinder jars of pottery remained in the sand, bearing inscriptions (Fig. 2) which give the name of the "Horus Ka," with the personal



FIG. 2.—Names of king Ka,
on jar.



FIG. 3.—Name of queen
Ha, on jar.

name of "king Ap." Beside these there are other similar inscriptions (Fig. 3) of "Ha, wife of the Horus Ka." These are the oldest inscriptions known. In the same tomb was an impression of a small seal. From these remains we see that the system of inscribing the royal property, of sealing on clay with a cylinder seal,

and the free use of writing, were already in course of development, leading on to the civilisation which followed.

O. 7. RO  about 4910-4880 B.C.

Tomb at Abydos (P. Ab. i, 4, 5).
Sealing on clay (P. R. T. ii, xiii, 96).
Inscriptions on pottery (P. R. T. i, xlv, 2-9).

مسی کا نمایا ہوا ہر س

The tomb of this king at Abydos is a brick-lined pit about twenty-two feet long and half as wide. It contained pieces of large jars of alabaster, and many great jars of pottery, the largest of their kind. The latter bore scratched marks of the hawk on the mouth hieroglyph, reading "Horus Ro." And near this was found a piece of a sealing with the same group. From the presence of alabaster jars, and the large pottery jars, this seems to be later than the tomb of Ka.

O. 8. ZESER  about 4880-4840 B.C.

Inscription on stone vase (P. R. T. i, iv, 3).

The tomb of this king has not been identified; but as two or three of the earliest royal tombs remain without names, it may well be one of those. The fragment of vase has well-finished signs upon it quite comparable with those of the 1st dynasty; yet it can hardly be brought nearer to that age, as the two following kings appear in highly advanced work. The name reappears as a royal name in two kings of the IIIrd dynasty; but it is here appropriate in a rising rule, as meaning the "enlarger" or



FIG. 4.—Stone vase inscription of Zeser.

"aggrandiser."

O. 9. NAR-MER



about 4840-4790 B.C.

Tomb at Abydos (P.R.T. ii, lviii, p. 7).

Sealings, Abydos (P.R.T. ii, xiii, 91-93).

Vases, Abydos (P.R.T. i, iv, 2; P.R.T. ii, pl. ii, 3, 6; lii, 359; M.E.P., fig. 811).

Ebony label, Abydos (P.R.T. ii, pl. ii, 4).

Slate palette, Hierakonpolis (Q.H. i, xxix; A.Z. xxxvi, 81).

Mace head, Hierakonpolis (Q.H. i, xxvi B).

Ivory cylinder, Hierakonpolis (Q.H. i, xv, 7).

There is some uncertainty as to whether the fish *nar* is to be taken alone as the *Ka* or Horus name; and the chisel *mer* as the personal name: such a division is suggested by the arrangement on the sealing.

From the great mace head we learn that Narmer had captured 120,000 men, 400,000 oxen, and 1,422,000 goats. We thus see that already the full system of numeration was complete. On the mace is shown the king seated in state under a canopy, raised on a platform reached by nine steps; while before him is a dance of captives, and apparently the captive chief in a palanquin. Four standards of the army are borne aloft, the same as on the slate palette. Behind the king is his body servant and the leader of the ceremonies (*thet*), together with attendants.



FIG. 5.—Sealing of Nar-mer.

On the great slate palette is a somewhat similar scene, where the king, with the same officials and standards, goes in procession to a ceremony of victory over his decapitated enemies. At the base is the king as a strong bull breaking a fortress and trampling on his enemy. On the other side, the group of the king smiting his kneeling enemy appears, as in all later

ages down to Roman times: the enemy is the *ua she*, or chief of the lake, apparently showing that Narmer

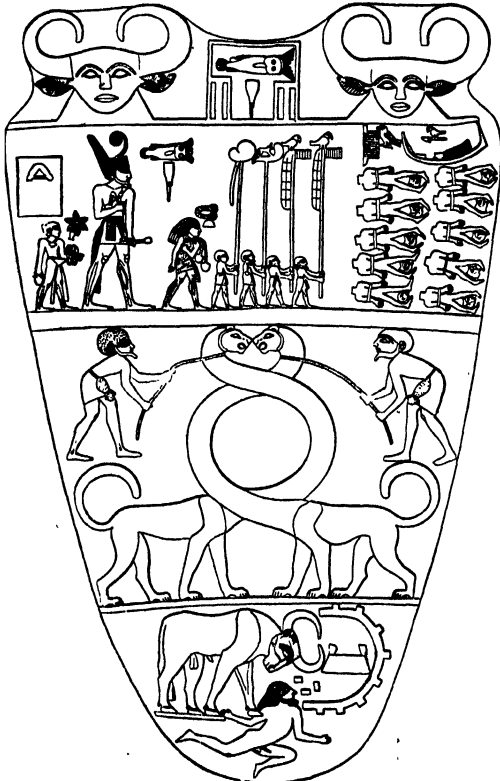



FIG. 5A.—Slate palette of Nar-mer.

had conquered the Fayum. For pictures of the slate, see S.B.A. xxii, 126.

The tomb of Narmer is probably the first of the

larger tombs ; it is a brick-lined pit 26 feet by 16 feet. Near it was found a large alabaster jar of the king ; and in the neighbourhood were many sealings, which had doubtless been placed on the vases of offerings. Other pieces of inscribed vases are also known, an ebony label and an ivory cylinder. From the grouping it seems probable that the great deposit of objects at Hierakonpolis is of this reign.

O. 10. SMA  about 4790-4777 B.C.

Inscriptions from vases, etc. (P.R.T. ii, pl. ii ; P.Ab. i, pl. iv).
Daughter—Neit-hotep (P.R.T. ii, pl. ii).

This king is only known by inscriptions upon vases of basalt, crystal, syenite, and ivory, on all which is found the form *nebui sma*. His tomb is probably a larger brick-lined pit, like that of his predecessor (P.R.T. ii, 7). One object with his name is an ivory lid of a kohl palette, which has also the name of Neit-hotep. As this same name occurs on the labels of necklaces found in the great tomb at Naqada, with the tablet of Mena, it is probable that Neit-hotep was a daughter of Sma, who was married to Mena, and died as his queen. Her toilet objects passed to her servants, and this lid was thus found buried in the grave of one of the domestics of king Zer, the successor of Mena.

The name of this king—the uniter—is most appropriate for the ruler, who united all Egypt, ready for the reign of the first king of the whole land, the great king Mena.

In this series of kings we see considerable changes, from the tomb of Ka-Ap, which, with its pottery, might well be a late prehistoric grave, to the far larger and more solid tomb of Narmer and the great slate palette with scenes which foreshadow the regular art of Egypt.

There may perhaps be another king, designated by the scorpion, whose objects may be recognised in the mace head and vases from Hierakonpolis (Q.H. i, pls. xxvi c, xix, xx, xxxiii, xxxiv). But as no trace of such a name has been found at Abydos, the individuality and position of this king are still uncertain.

THE FIRST DYNASTY. *Long 6'*

	MANETHO.	LISTS.	MONUMENTS.	YEARS.	B.C. about
1	Mēnēs	Mena A. T.	Aha-Men	62	4777
2	Athōthis	Teta A.	Zer-Ta	57	4715
3	Kenkenēs	Ateth A.	Zet-Ath	31	4658
4	Uenefēs	Ata A.	Den-Merneit	23	4627
5	Usafaidos	Hesepti A. T.	Den-Setui	20	4604
6	Miebidos	Mer'ba'p A. Mer'ba'pen S. T.	Azab-Merpaba	26	4584
7	Semempēsēs	Sem'en'ptah? A.	M e r s e k h a - shemsu	18	4558
8	Biēnekhēs	Kebh A. S. T.	Qa-Sen	26	4540
					4514

We now reach the beginning of the continuous detailed history. There are very possibly not more than half a dozen successive transcripts of the lists, between the compilation in the early dynasties and the copy of the history of Julius Africanus which we can handle at present, giving the abstract of the history of Manetho. In comparing the account of this dynasty thus transmitted to us, with that recoverable from the contemporary monuments, we can identify by name Nos. 1, 2, 5, 6, 7; and we find a corresponding number of intermediate names, so that we have practically a verification of the oldest statements of the written history.

The monumental lists are: (1) the table of kings at Abydos in the temple of Sety I, which is the most complete and authentic document preserved (marked A in the dynastic table); (2) the duplicate list by Ramessu II, of which portions are in the British Museum; (3) the list in the tomb of Thunury at Saqqara, now in the Cairo Museum (marked S above); (4) the papyrus of

kings in Turin (marked T above), which before its partial destruction was the most valuable record known ; (5) the list of Tahutmes III from Karnak, now in Bib. Nat., Paris, which has very little value in the order of it.

The actual monuments consist of the steles, vases,

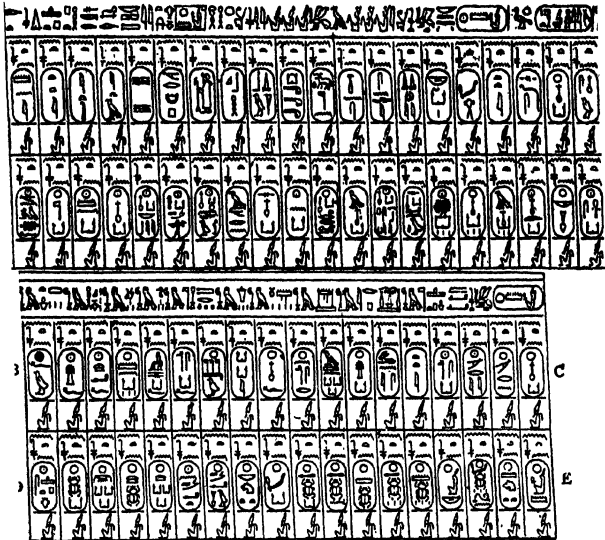

FIG. 6.—List of kings, Table of Abydos.

and sealings found in the royal tombs at Abydos ; and from the relation of inscriptions on re-used vases, from the successive styles of the sealings, and from the relative position of the tombs, there can be no doubt of the order of the kings being as here stated.

Though the inscribed fragment known as the Palermo stone has not preserved any names of the 1st dynasty,

yet it manifestly refers to this period, and we must briefly state its nature and importance, which has lately been shown by the work of Dr. Schäfer, *Ein Bruchstück Altägyptischer Annalen*. This slab, which has been broken from a larger monument, bears first a list of the kings of Lower Egypt, as yet unknown elsewhere,

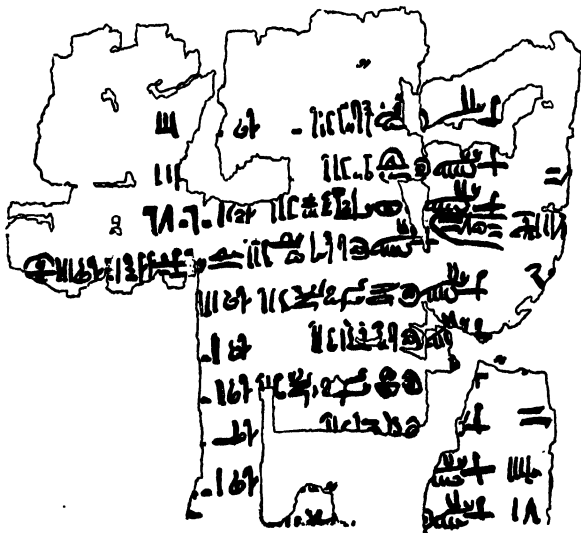

FIG. 6A.—Portion of Turin papyrus.

named . . . pu, Seka, Kha-au, Tau, Thesh, Nehab, Uaz-ānd, Mekhet; next come rows of yearly entries of single events from which the years were named, forming a table of yearly annals of each king, probably beginning with Mena. A king (Zer?) ends at 6 months 7 days; the next (Zet?) has 4 months 13 days before a whole year, leaving an interregnum of 1 month 10 days. The

Seneferu (IIIrd dyn.), Shepseskaf, and Userkaf, in whose reign it was carved. After that Sahura and Neferkara scratched their annals slightly upon the stone. Each yearly entry has the level of the high Nile placed below it, forming a regular register of the Nilometer; the levels vary from 1 to 8 cubits, an extent of variation the same as in Roman times and in the present day. The entries concerning these kings will be found noticed in their proper places. But the great value of this piece of the annals is in showing that in the Vth dynasty there was a complete record, for a thousand years before that, of the reigns to a single day, and of the annals year by year of every king, probably from Menes onward. This shows what a solid basis there was for the dynastic lists described above, and how far more was recorded in detail than has come down to us in these royal lists.

I. I. AHA-
MENA



about 4777-
4715 B.C.

Tomb at Abydos (P.R.T. ii, 7, 8).

Ebony labels, Abydos (P.R.T. ii, pls. iii, iii A, x, xi).

Stone vases, Abydos (P.R.T. i, iv, 1; R.T. ii, iii, 5, 7).

Gold bar, Abydos (P.R.T. ii, iii A, 7; Ab. i, xiii, 171).

Clay sealings, Abydos (P.R.T. ii, xiv, 97-104).

Clay sealings, Naqada (M.E.P. Figs. 522-526, 556-558).

Ivory label, Naqada (M.E.P. Fig. 549).

Queen NEIT-HOTEP (P.R.T. ii, 4).

Tomb at Naqada (M.E.P. 147-202; A.Z. xxxvi, 87).

Ivory labels, Naqada (M.E.P. Figs. 551-554).

Vases, Naqada (M.E.P. Figs. 618, 677).

Ivory vase and kohl lids (P.R.T. ii, pl. ii, 11, 12; xxxii, 67).

Alabaster vase (P. Ab. i, iv, 6).

Clay sealing (M.E.P. Fig. 559)

Daughters BENER-AB. Tomb, Abydos (P.R.T. ii, 8).

Ivory label, etc. (P.R.T. ii, iii, 1; iii A, 4, 9, 11, 12, 13;

iv, 10; M.E.P. Figs. 813, 814; P. Ab. i, iv, 3).

SHET (?) (M.E.P. Figs. 550, 555).

The ... en is proved
by ... where the

name Men is preceded by the titles vulture and uræus lord (*nebti*), just as the personal name Sen has the same titles later on in this dynasty.

On one seal (93, see R.T. ii, xiii) of Narmer his name alternates with Men; just as on a seal (99) of Aha his name alternates with Het. From another seal (116) we learn that Het was the chamberlain of the king (like the *hon* chamberlain of Narmer (Fig. 7); and hence Men may probably have been the chamberlain of Narmer. The change of dynasty shows that there was some break in the family succession. And the presence of a *ka*-name seal for Neit-hotep (M.E.P. Fig. 559) agrees with her being of great importance as the heiress of dynasty O, who transmitted the royal rights to Mena and so legitimated the 1st dynasty. The reign of Sma appears to have been short, by the small number of his remains; and hence there would be no difficulty in Mena having been the chamberlain at the death of Narmer, and yet having a long reign afterwards.

The tomb of Mena was supposed to be that at Naqada in which was found the ivory label with his name. As, however, several large labels and other objects of the same king were found at Abydos, while at Naqada the queen Neit-hotep is often named, it now appears that the Naqada tomb is that of the queen; while Mena was buried at Abydos. His tomb there is a large brick-lined pit (R.T. ii, lviii), which has had upright posts along the sides to support an inner chamber of wood. A short way in front of that is the grave of his daughter Bener-ab and another like it, with thirty-four other graves arranged in three rows; these appear to have contained the household of Mena, as no name but his was found on the sealings which remained.

On the ebony tablet (Fig. 7) the king (?) is offering for the fourth time a bowl of electrum (*uasm*); at the se are perhaps named the chief of the city Theast, (queen) Haaut, the second ished as

The ebony labels of Mena show the earliest known use of hieroglyphs for continuous writing, and bear figures of shrines, a fort, offerings, and apparently the sacrifice of captives (R.T. ii, iii, 4, 6). The gold bar with the name of Aha is a surprising object, which is as yet quite unexplained (P.Ab. i, xiii, 171).

From the fragments of history which survived it appears that the great work of Mena lay in the development of his newly united kingdom; not regarding the north as merely a land of wars and raids, but as the

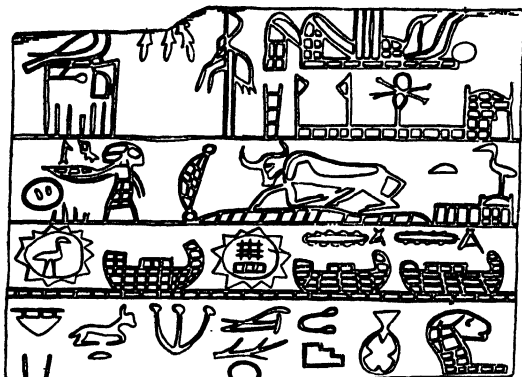

FIG. 7.—Ebony label of Mena.

valued addition to the old kingdom of the south, needing a new capital, and great canal works to reclaim the land and establish a rich and fertile territory.

The record of the death of Mena, as killed by a hippopotamus, is unlikely, considering his long reign and great age; for at over eighty he would not be wrestling with hippopotami like his successor Setui. Looking at the brief and undeveloped use of hieroglyphs at this age, it is probable that some early record has been misunderstood by later historians.

Of the great tomb at Naqada

is fully published as regards its form (A.Z. xxxvi, 87); and many kinds of objects from it are figured (M.E.P. 147-202), though it has been by no means completely cleared. Her name is found on the ivory labels for necklaces and also on stone vases. The necklace labels show that they were for strings of 75, 123, 123, and 164 beads respectively. A seal found there also appears to give her *ka*-name, arranged much like that of a king, but without the hawk on the building (M.E.P. 559). Three ivory toilet pieces of this queen were found at Abydos, belonging to domestics of the next reign.

The princess Bener-ab appears to have been probably a daughter of Mena. Her name occurs on ten ivory toilet objects, which probably all came from her tomb.

Another name, Shet, is found on two of the necklace labels in the tomb of Neit-hotep (M.E.P. 550, 555); and it seems by analogy that this is also a princess of this reign, perhaps a daughter of Neit-hotep.

In later times Mena was venerated. His statue is carried in a procession of the kings by Ramessu II (L.D. iii, 163). There are two priests of his, Senb'f of the XXVIth dynasty (L.D. iii, 276 b), and Un'nefer of Ptolemaic age (Serapeum stele 328). Also scarabs of later times bear his name, and jewellery (Pr. M. xlvii) now in New York.

I. 2. ZER-TA



about 4715-4658 B.C.

Tomb at Abydos (P.R.T. ii, 8; pls. lx, lvi).

Stele (Cairo).

Ivory labels (P.R.T. ii, v, 1, 2; vi A, 2).

Ivory vessels (P.R.T. ii, v, 4, 7; v A, 4, 5).

Clay sealings (P.R.T. ii, v, 17; vi A, 18; xv, 105-110).

Wood, inscribed (P.R.T. ii, vi A, 4; xii, 3).

Pot, engraved (P.Ab. i, xi, 1).

The tomb of Zer is much larger than any of the earlier royal tombs, the wooden chamber having been about the whole pit with the offering chamber. In addition

to the king's tomb there are seven rows of graves of the household around it, less deeply sunk in the ground, in all 338 graves; from these graves come more than seventy steles of private persons, nearly all women, and therefore probably of the royal *harem*. Pieces of the great limestone stele of the king were also found, and have been joined so as to restore nearly the whole of it.

The royal seal, with figures of Zer seated as king of Upper and Lower Egypt, shows the adoption of the permanent type of later ages. Another seal bears, in alternation with Zeren, the name Ta, which seems to be the personal name of the king, rendered as Teta in the list of Sety.

An ivory label (R. T. ii, v, 1) suggests that Zer was the founder of the city of Buto in the Delta, which is not unlikely in the next reign after the founding of Memphis. Another label (R. T. ii, v, 2) shows a fortress named *Zer-ab-hor*, or it may be that *ser* has the determinative *ab*, as having the meaning of the man of will or *determination*. A wooden label with painted inscription (R. T. ii, xii, 3) shows a palace named Qed-hotep, "making peace," like "*mon repos.*"

The small objects of this reign include the ivory cups with the name (R. T. ii, v, 7, v A, 4, 5); a piece of ivory tablet with the queen seated on the king's knee (v A, 12); a piece with the king spearing the crocodile (?) (v A, 8); two ivory lions for a game (vi, 3, 4), and a multitude of small articles of interest (R. T. ii, v-vi A, xxxiv-xxxvi).

The most important discovery of this age is the jewellery found on the arm of the queen in the royal tomb; this consisted of four bracelets, all different in design, and showing mastery of gold work and soldering (R. T. ii, pl. i, and pp. 16-19).

In the summary of Manetho it is recorded that Athothis built the palace at Memphis; but as no stone-



FIG. 8.—Ivory label of Zer.

work appears till later it is probable that this refers to buildings of brick and woodwork, like the material of the royal tombs. The king is also said to have been a



FIG. 8A.—Jewellery of queen of Zer.

physician, and to have written on anatomy; but this may be due to later medical works being attributed to his reign to give them a standing.

I. 3. ZET-ATH



about 4658-4627 B. C.

Tomb at Abydos (P.R.T. i, 8-10; pls. lxi-lxiv).

Stele (Cairo; M.E.P. Fig. 797).

Stone vases (P.R.T. i, iv, 4; ii, vii, 1, 2, 4).

Ivory label, etc. (P.R.T. i, x, 8, 9, 10; xiii, 1-5; Ab. i, xi, 3).

Ivory boat model (P.R.T. i, xiii, 6).

Clay sealings (P.R.T. i, xviii, 1-10; R. T. ii, xvii, 125-130).

Hieratic inscription (P.R.T. i, xix, 11).

The tomb of this king at Abydos consisted of a wooden chamber about 19×29 feet; with brick partitions for cells of offerings around it, in a brick-lined pit 31×40 feet. Around the tomb on all sides were rows of graves of domestics and officials, 174 in all; from these about twenty steles have been obtained, and sixteen graves have the names painted on the walls. The royal stele is in the Cairo Museum; on it we see

the usual convention of the panelled work entirely established.

There are no important vase or label inscriptions; but the seals

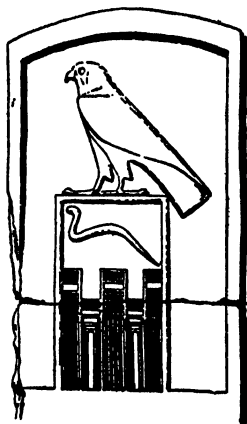

FIG. 9.—Stele of Zet.



FIG. 9A.—Seal of Zet.

show not only the king's name Zet, but the same alternating with Ath (P.R.T. i, xviii, 2), which seems to be the name preserved in Sety's list as Ateth. Other seals give the title *ad mer* (No. 6); and apparently another title *sehes ka* (Nos. 5, 6, 7). A stone cylinder seems to name this king, in Ash. Mus. (S.B.A. xx, 98). The hieratic accounts on a potsherd show that such account keeping was in full use. A statue of a priest of Atet—perhaps this same king—is in Berlin (XXVIth dyn., A.Z. xxxviii, 117).

I. 4. DEN-MERNEIT



about 4627-
4604 B.C.

Tomb, Abydos (P.R.T. i, 11; pls. lxi, lxiv, lxv).

Stele (P.R.T. i, front).

Stone vases (P.R.T. i, v, 1-7; R.T. ii, v, 5, 6; vA, 21).

Clay sealings (P.R.T. i, xx, 12-43; ii, xvii, 131-135).

Small objects (P.R.T. ii, xxxix).

The tomb of Merneit is a finely built brick chamber, about 21 x 30 feet; around it on all sides are chambers for offerings built into the same mass. Around that, at a short distance, is a simple line of graves of domestics, forty-two in number, from which a few steles were obtained. This tomb is by far the most carefully built of all, both in the symmetric planning of it and the regular construction. But, curiously, it is the poorest in tomb furniture.

The separate identity of this king may be challenged on two grounds. The stele is not like that of the other kings, and the sealings in the tomb all bear the name Den, like that of Den-Setui. The separation from Den-Setui is, however, proved by the fact that not one of the thirty-seven seals of the Merneit tomb is the same as any of forty-one seals of the Setui tomb. It would be impossible to suppose that, if all belonged to one reign, not a single seal should have been used for the offerings in both of the buildings. Also, the large coarse style of the earlier sealings is found on those of Merneit (see Nos. 18, 19, 29, 42, 43), but is not found on those of Setui. One seal (No. 26) appears to give the names Den and Merneit conjoined.

The stele gives the personal name Merneit, and not the Horus-name; while a second stele (the back of which found in the tomb) may very possibly have given the Horus-name. The only solution of the whole question is to see two kings who each had the Horus-name Den, one being named Merneit, the other Setui.

The vase inscriptions are all very rough, excepting one which is fairly cut. The seals are of interest; one gives a list of nomes (No. 135) in which we can recognise the Vth, VIIth, IXth, XVth, and XVIIth of Upper Egypt; the title of *ad mer* often occurs; the vineyard (31), the wine-press of the eastern nomes and the western nomes (37, 38), the royal sealer of the wine (?) of Neit (39), and the wine-store of the hog (33, comp. 60). There is much more detail and development of public officials here than appears before.



FIG. 10.—Inscription of Merneit.

By the order in Manetho this king appears as Uenefēs, in whose time was a great famine, and who built the pyramids near Khōkhōme, or in the Armenian Khoe. This has been supposed to refer to *Ka kem*, the name of a district of Saqqara; but it may well be read as “the village of Khō,” and refer possibly to Quu (demotic), now Qau, between Abydos and Asyut. In any case “pyramids” are probably a misunderstanding for some other form of building at this age.

I. 5. DEN-
SETUI



about 4604-
4584.

Tomb, Abydos (P.R.T. ii, 9; lxii).

Stone vases (P.R.T. i, v; R.T. ii, vii; A.Z. xxxv, 3).

Ink inscriptions (P.R.T. i, x, 1; ii, xxv, 17, 18).

Ivory and ebony labels, etc. (P.R.T. i, x, xi, xiv, xv, xvi;

R.T. ii, vii, viiA; P.Ab. i, xi; A.Z. xxxv, 2, 8; M.E.P. Fig. 782).

Granite mortar (A.A. 1899, xli).

Clay sealings (P.R.T. i, xxiv, xxv; R.T. ii, vii, xviii-xx).

The tomb at Abydos is a great brick-lined pit about 28 x 50 feet, with a stairway 78 feet long descending into it. It was paved with blocks of granite, an astonishing magnificence, as no stone building was

known till three centuries later. Upon the granite stood an inner chamber of wood, leaving a clear space over three feet wide between that and the pit side, in which

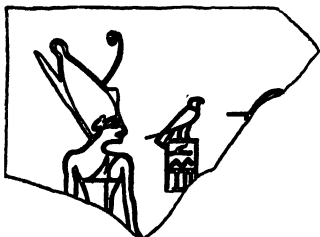

FIG. II.—Den on a label.

offerings were deposited. This space is the equivalent of the brick partitions of Zer and Zet, and the girde of offering chambers of Merneit. At the S. corner a chamber at a higher level outside of the tomb had a stairway descending to it, perhaps the tomb of a prince. Around the

tomb are rows of graves on all sides, altogether 137; by which about 40 steles have been found, both of men and of women.

The correspondence of the names Den and Setui is shown on several inscriptions; the personal seal of the king (R.T. ii, vii, 5, 6) gives Setui in alternation with Den between the figures of the king; the sealing 151 shows the same connection; and the ebony tablets (R.T. i, xv, 16, 18; R.T. ii, vii, 11; Ab. i, xi, 8) also give the full title *suten bity setui*.

Though the stone vases are of no great importance, the ebony and ivory tablets are fuller and more numerous than those of any other reign. There are frequently duplicates, which serve in unravelling the order and grouping of the signs. Among these the most striking are those with figures of the king (R.T. i, xiv, 7, 9), with the king slaying the Easterner (A.Z. xxxv, 8), with the *sed* festival (R.T. i, xiv, 12), with the dancing



FIG. IIIA.—Lid of seal box.

festival (xv, 16), with "the great chiefs coming to the tomb" (xvi, 20), with the shrine of the sacred ram (R.T. ii, vii, 8), with Den fishing (vii, 11), and the beautifully engraved lid of the box for the golden seal of judgment (vii, 12).

The clay sealings show a spread of officialism in the increase of titles. The chancellor Hemaka was the great man of the age; his name is placed, larger than that of the king, on the ebony tablet (R.T. i, xv, 16), and is frequent on seals (R.T. i, xxv, 53, 54, 55, 56; ii, xx, 161). We find also several fortified places named, *Se-khent du Hor*, *Tep khet Hor*, *An khet Hor*, and *Un*: these point to the enlargement of the frontiers and establishment of military power. There are six different seals of superintendents of the inundation.

In general the reign of Setui seems to have been the richest and most splendid of the whole dynasty. There is no detail given by Manetho, who states the name as Usafaidos, a form of Hesepti given on the table of Sety, owing to the *hesep* sign being confounded with the *set* sign in hieratic transcript. In the medical papyrus of Berlin this king is mentioned, also in the Ebers papyrus (103, 2), and chapters of the Book of the Dead are attributed to his time.

I. 6. AZAB-MERPABA



about 4584-
4558 B.C.

Tomb, *Hor-ha-sa*, Abydos (P.R.T. i, 12; lxi, lxxv, lxxvi).

Stone vases (P.R.T. i, v, 9, 11, 12; vi; R.T. ii, viii A, 1, 2;

Ab. i, v; M.E.P. Fig. 811; A.Z. xxxv, 2).

Clay sealings (P.R.T. i, xxvi, xxvii).

This tomb is the poorest in construction and in remains of all those of the 1st dynasty. The brick-lined chamber is 14 x 22 feet, and a smaller chamber adjoining it for offerings is 14 x 9 feet. The ground chamber is reached by a flight of brick steps; it was floored and roofed with wood. Around it on all sides are rows of private graves of domestics, very roughly built, sixty-four in all. Only one stele was found

in the whole group. The vases of Azab were mainly kept back by his successor, and his name erased from them; for out of a dozen inscribed pieces, only one was found in the king's tomb.

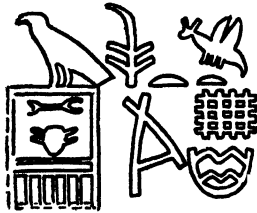

FIG. 12.—Seal of Azab.

12A); this vase was subsequently dedicated in his grave, which is named *Hor ha sa* (emblematised by a funeral stele placed on three steps), and the vase was used, probably for cedar oil, named on it *āsh*, and determined by a bundle of logs of wood tied together. A large number of pottery jars were made for the tombs, and have the inscription *ha sa* on them (see forty-five examples in P.R.T. i, xlvi); these may refer to *Hor ha sa* of Azab, *Neb ha sa* of Qa (Ab. i, v), or *Ra-neb-sa-ha* of Ra-neb (R.T. ii, viii, 12); evidently *ha sa* was the common name for the royal tomb in each reign, "the place of the greatest protection."

From the seals of Azab, it seems that the palace was known as the dwelling of *Hor-pa-ua*, "Horus the chief," or "this leader Horus." For the first time we

The palace of the king was named *Qed-hotep*, like that of Zer (R.T. i, vi, 8); and a fortified place was named *Dua khet Hor*, like the names of the forts of Setui. This was occupied as a royal residence, as an alabaster vase is inscribed for this fort of Azab (Fig.



FIG. 12A.—Inscription of Azab.

find the *ka* name and *suten bity* name placed side by side as in later ages (seal 57, see Figure 12). The wine store of the hog is named again (seal 60); there are several seals of an official Sab, probably the vizier (Nos. 64, 65, 66, 67); vineyards of the king are named (68), and overseers of the inundation (67, 69).

I. 7. MERSEKHA-SHEMSU



about 4558-
4540 B.C.

Tomb, Abydos (P.R.T. i, 13; lxvi, lxvii).

Stele (M.E.P. Fig. 780).

Ivory labels (P.R.T. i, xii, 1; xvii, 26; R.T. ii, viii, 5; Ab. i, xi, 9).

Stone vases (P.R.T. i, vii; A.Z. xxxv, 3).

Clay sealings (P.R.T. i, xxviii).

Inscribed pottery jars (P.R.T. i, xliv, 10-102).

There is some uncertainty as to the reading of both the names of this king. Though *Semerket* would be far preferable in sense, yet it is written in every case *mer s*. The personal name is shown by a standing figure holding a stick; this was made by Sety into a figure of Ptah, and it was conjectured that this read *sem en plah*, "the image, or manifestation, of Ptah," yielding the form *Semempses* in Manetho. From the original figure it seems more likely to be a follower, *Shemsu*, which might originate the form *Semempses*.

The tomb at Abydos is 25 × 44 feet, with a sloping passage down into it; the floor was covered with wooden beams fitted in a framing, probably belonging to a wooden chamber which stood free in the pit. Close around the pit are two rows of graves, about seventy-two in all, from which come over a dozen steles. The large royal stele of hard black quartzose stone is now in Cairo Museum.

The few stone vases inscribed show nothing of importance, except a *sed heb* festival, which occurs before under Setui. But the seals show more; the palace was named from "This Horus, Nebti Shemsu"; one small seal was for sealing "mouth wash for the royal house," probably natron; other seals are for the wine

of various kinds from the place of the golden bull; and another for wine from the fortress Khent. A fort named Hor-zeser-nub is also mentioned.

From Manetho it seems that the dynasty was weakening, as it is said that there were many villanies and much corruption, the State apparently falling into anarchy.

I. 8. QA-SEN    about 4540-4514 B.C.

Tomb, Abydos (P.R.T. i, 14; lx; lxvi; lxvii).

Steles (P.Ab. i, v; M.E.P. Fig. 779).

Ivory labels (P.R.T. i, xi, 12; xii, 2; xvii, 28, 29; R.T. ii, viii, 1-4; P.Ab. i, xi, 10, 11).

Wooden cylinder (P.R.T. ii, xii, 5).

Stone vases (P.R.T. i, viii, ix; R.T. ii, viii, 6, 7; viii A, 4, 5; Ab. i, v, 2; M.E.P. Fig. 812; A.Z. xxxv, 5).

Sealings (P.R.T. i, xxix, 78 86).

The tomb at Abydos differs from those before it in having large chambers for offerings, two opening from off the entrance stairway on either hand. The wooden chamber was 17 × 34 feet (exactly the size of the tomb of Khufu, 10 × 20 cubits), and fitted closely into the brick-lined pit. Around it were fourteen chambers of offerings, and twenty-four graves of domestics, from which come perhaps a dozen steles.

The great steles of the king were on the east side of the tomb, on the upper level; and near one of them was a large quantity of alabaster offering bowls, and one diorite bowl inscribed for the "*sem* priest of the temple of king Qa." Some doubt exists whether the name should be read Qaā or Qadu, according as the arm is read ā or du. The second name of the king, Sen, is written with the spear-head *sen*, the complement *n*, and the determinative of a nose (R.T. ii, xii, 6; Ab. i, xi, 11), showing the meaning to be "to breathe" or smell. The deep form of the sign *sen* was quite unknown in later times; and, with the wavy *n* beneath it, it was mistaken for the vase *qebh* and water sign, and thus started the misreading *Qebh* of the lists in the XIXth dynasty.

The ivory labels name apparently four high officials ; the *tep ha* or first peer, who was named *Khet-sha* in the last reign, and *Ga(?)aha*, and *Kehennu*, here ; the royal constructor, who was named *Henuka* in the last reign and this, and *Nefer* later on ; the follower of the king named *Sha* ; and the doer of things, or master of ceremonies, *Sap(?)*.

An ivory gaming reed with a figure of a captive is a striking piece of work, showing well the Libyan type.

The stone vases with inscriptions are numerous, and some bear interesting details. The *sed festival* occurs (R. T. i, viii, 6, 7) ; the palace was named *hat Hor-pa-ua*, "the house of this princely Horus" (R. T. i, ix, 1) ; and on the same bowl is the dedication for the tomb *Sa-neb-ha* (or *Sa-ha-neb*, as it is named on the next bowl). Others show a boat (R. T. i, viii, 9 ; ii, viii, 6), probably meaning that the bowls belonged to the royal boat. Two bowls belonged to the *sem* priest of the royal shrine (R. T. i, viii, 5 ; ix, 12).

The seals of this reign are but few, though impressions are very common. They only name the manager of the inundation, and a fort entitled *Hor-nub-khet*.



FIG. 13.—
Captive
on ivory.

Throughout this dynasty there are many uninscribed remains, stone vases, ivory and wood carving, etc., belonging to the tombs of the various kings, to which no references have been given here, as they do not bear the royal names. But all of these should be noticed in considering the civilisation of the time, and they will be found in the various works quoted for reference to the inscribed materials.

The general view of the rise of the kingdom of Egypt shows the gradual advance in the use of writing, rare and discontinuous before Mena ; then appearing in

consecutive sentences ; by the middle of the dynasty in full use on an abundance of tablets ; and at the end of the dynasty so common as to have become degraded and carelessly engraved.

In political position we see the records of the gradual conquest of the kingdom before Mena ; then the establishment of Memphis, and in the next reign that of Buto ; by the middle of the dynasty the conquest of the eastern border ; and at the end of the dynasty the figure of a Libyan captive.

In internal organisation we see the gradual growth of a bureaucracy ; the first office is that of chamberlain under Narmer and Mena ; next, the manager of the inundation under Zer ; the *ad mer* under Zat ; the list of nomes, and the keeper of the wine under Merneit ; the royal seal-bearer and royal architect under Setui ; the keeper of the royal vineyards under Azab ; the leader of the peers (*tep ha*), and the follower of the king, under Mersekha ; the master of the ceremonies (*ar khet*) under Qa. The reign of Zer is that of the first fresh completion of the style, under Den is the greatest magnificence, and under Mersekha political corruption ; these are the Louis IXth, XIVth, and XVIth of that age. The history of Egypt is no longer a strange enigma to us, but stands now on the same lines as that of the development of other monarchies.

CHAPTER II

THE SECOND AND THIRD DYNASTIES

THE names of the IInd dynasty vary in the different lists ; and as the confusion runs through into the IIIrd dynasty, it will be best to state the sources throughout.

	MANETHO. AFRICANUS.	ABYDOS. SETY I.	TURIN PAPYRUS.	SAQQARA. THUNURY.
	<i>II. dyn.</i>			
1	Boëthos	Bezau		Neter-bau
2	Kaiekhos	Ka-kau		Ka-kau
3	Binöthris	Baneteren		Banetru
4	Tias	Uaznes	(frag. 19)	Uaznes
5	Sethenēs	Senda	Send	Send
6	Khairēs	○	Neterka	○
7	Neferkherēs	○	(frag. 18)	Neferkara
8	Sesökhris	○	Neferka-sekru	Sekru-neferka
9	Khenerēs	○	Hezef . . .	Zefa
	<i>III dyn.</i>			
1	Nekherofēs	Zazay	Zazati	Beby
2	Tosorthros	Nebka	Nebka	(below Nebka)
		Zesersa	Zesera	Zeser
3	Turis	○	○	○
4	Mesökhris	○	○	○
5	Söufis	○	○	○
6	Tosertasis	Teta	Zeserti	Zeserteta
7	Akhēs	Sezes	(frag. 31)	Nebkara (upto 1)
8	Sifouris	Neferkara	Huni	Huni
9	Kerferēs X	Sneferu	Sneferu	Sneferu

Such are the materials in which the following difficulties occur. In Turin papyrus Neterka cannot be

No. 7, as there is a name lost between that and frag. 18: Zesera begins with title in red, as if he were then reckoned the founder of his dynasty. The papyrus corresponds with the other lists of the XIXth dyn. in having nothing between Nos. 3 and 6. The list of Saqqara is clearly corrupt in putting Beby for Zazay. Nebka is put down at 7, out of place according to Abydos and Turin lists. The Abydos list is peculiar in having no names between Senda and Zazay; but the evidence of all the other lists proves that there were other kings. The fitting of Manetho to the monumental lists has difficulties. Khairēs is probably Ra-ka, as on a cylinder; and so might be given as Neterka. Khenerēs and Nekherofēs are different to the monumental names. And, after Turis, the names Mesōkhris and Sōufis seem without any equivalents. And lastly, the name Sifouris must be Sneferu, and Kerferēs might be a corruption of Neferkerēs; if so, the names are transposed.

THE SECOND DYNASTY.

	MANETHO.	LISTS.	MONUMENTS.	YEARS.	B.C. about
1	Boēthos	Bezau	Hotep-ahaui	38	4514
2	Kaiekhos	Kakau	Ra-neb	39	4476
3	Binothris	Baneteren	Neteren	47	4437
4	Tias	Uaznes	Perabsen	17	4390
5	Sethenes	Senda	Send	41	4373
6	Khaires	Ka-neter	Ka-Ra	17	4332
7	Neferkheres	Neferkara	. . .	25	4315
8	Sesokhris	Sekerneferka	Kasekhem	48	4290
9	Kheneres	Hezef . . .	Khasekhemui	30	T.P. 4242
				28	4212
				302	

II. 1. HOTEP-AHAUI, BEZAU  about 4514-4476 B.C.

Stone vases (P.R.T. ii, viii, 8, 9, 10, 11; M.E.P. Fig. 851).

On figure No. 1, Cairo (M.E.P. Fig. 852).

Clay sealings, Saqqara (A.S. iii, 187).

The granite kneeling figure in the Cairo Museum with the *ka* names of three kings on the shoulder is the principal evidence for the beginning of this dynasty.



FIG. 14.—Granite statue No. 1, Memphis.

That the names of Ra-neb and Neteren are in right order is proved by an erased vase (see below); and therefore Hotep-ahai may be accepted as coming next before them. Whether the latter signs are *aha* might be questioned; but *sekhem* never has the open top in hieroglyphs, only in hieratic.

The pieces of stone vases were found in the tombs of Perabsen and Khasekhemui. They men-



FIG. 14A.—*Ka* names on statue No. 1.

tion the name of the palace, "the dwelling of the *Ka* of the Horus Hotep-ahai, *Akhut en neter*." Another fragment (M.E.P. 851) gives the name of the tomb, *Sa-ha-ka*. The clay sealings found at Saqqara

give the name Hotep as apparently that of the king. They suggest that the royal tomb was at Saqqara.

Of the reign of Bezau we read that there was a chasm at Bubastis, and many persons perished; as that is the region of volcanic action, shown by the basalt beds of Abu Zabel, it is not unlikely that an earthquake, and a great fault in the earth; might occur there.

II. 2. RA-NEB KA-KAU  about 4476-4437 B.C.

Stone vase, erased (P.R.T. ii, viii, 12).
On figure No. 1, Cairo (M.E.P. Fig. 852).
Clay sealings, Saqqara (A.S. iii, 188).

That Ra-neb preceded the following king is certain from the erased inscription on a bowl, which was

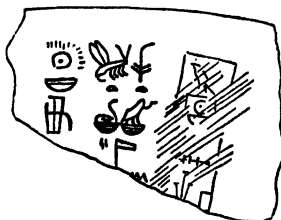

3 FIG. 15.—Inscription of Ra-neb
erased by Neteren.

dedicated at his tomb. The sealings name the palace of *Hor-pa-ua*, and point to the tomb being at Saqqara. In Manetho we read of Ka-kau establishing the worship of the bulls Apis at Memphis and Mnevis at Heliopolis, and the Mendesian goat.

This seems to point to the IIInd dynasty being more connected with the older population, and bringing back an animal worship which was probably primitive in the country.

II. 3. NETER-EN = BA-NETER-EN  about 4437-4390 B.C.

Stone vases (P.R.T. ii, viii, 12, 13).
On figure No. 1, Cairo (M.E.P. Fig. 852).

One bowl had belonged to Ra-neb (Fig. 15), and was taken for the "daily washing" of Neteren. The

other bowl belonged to the king's travelling equipage, being marked with the boat (Fig. 16).

This king is mentioned on the Palermo list (S.A. 22), where his reign must have been stated as over thirty-five years. The building of the palace in the 6th year is named; an Apis in the 8th and 14th years; and the building of the towns *Shemra* and *Ha* in the 12th year. His identity with the third in Manetho and the lists is well proved by the personal name, only differing by *Ba* prefixed in later times. He is recorded by Manetho to have ordained that the throne might pass in the female line. This



FIG. 16.—Vase of Neteren, inscription.

again is probably another reversion to the prehistoric system; and shows the weakening of the dynastic law of the 1st dynasty, which is expressly stated to pass from father to son.

II. 4. SEKHEM-AB,
PERABSEN, UAZNES



about 4390-
4373 B.C.

Tomb, Abydos (P.R.T. ii, 11; lxi).

Steles (P.R.T. ii, xxxi).

Stone vases (P.R.T. i, iv, 7).

Clay sealings (P.R.T. ii, viii A, 7; xxi, 164-190).

The tomb at Abydos differs much from the tombs of the 1st dynasty; and as the burials of the previous three kings are unknown, we cannot trace the derivation of the details. The central chamber shows no signs of a wood floor or lining. Around it are small brick chambers for offerings; and, outside them again, a passage running around the whole tomb, 42 x 53 feet outside measurement. There are no private graves of domestics around the royal tomb, as there are with all those of the 1st dynasty.

Two steles were found near the entrance at the S.W.

corner of the tomb. These are long blocks of dark grey syenite, apparently almost in natural form, with one flattened face, on the surface of which are inscriptions in relief, giving the Set-name Perabsen.



FIG. 17.—Seal of Perabsen,
Set-name.

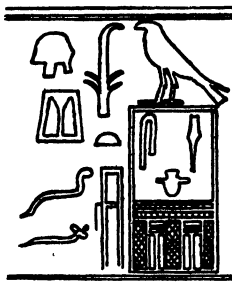

FIG. 17A.—Seal of Perabsen,
Horus-name.

The position of the king is certainly after the three already noticed, and probably not long after them, as nearly all the inscriptions known of those kings were found in the tomb of Perabsen, who had kept their vases in use till his burial. He cannot be the same as Send, as there are separate priesthoods of the two kings in later time. So he is best placed as equivalent to Uaznes; but it is possible that he might be later in this dynasty. He had the peculiarity of a Set-name *Perabsen*, as well as a Horus-name *Sekhem-ab*.

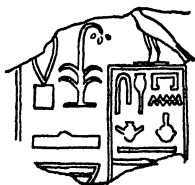

FIG. 17B.—Seal of Perabsen,
joint-name.

No trace of the list-name Uaznes has been found. In one instance the two names are combined on a sealing, from an unknown site (F.P. Coll.).

The clay sealings give many titles which are unknown earlier; and they show more precision and minuteness in workmanship, probably due to the use of stone and metal instead of wood. Among the titles is the

"Southern sealer of all documents" (164); "Chief recorder of provisions under the king" (165); "Recorder of provisions, scribe" (166); "Collector (?) of lotus grain" (171); "Store house of provisions of Amu," the third nome of the Delta (174); "House of the things of Isis" (176); "Sealer of provisions, Shesh . . ." (177); the *ad mer* (governor) of a fortification named after "the prince's ships" (178-180); "Sealer of the transport of the north" (184); "Sealer of all vases," *nenhu* (185); "Scribe of the secrets" (189). Figures of the gods first appear in this reign, where Osiris and Set are both named as "beloved of Horus" (the king).

The style of workmanship, the elaboration of titles, and the divine figures, all show that a great change had passed since the rule of the 1st dynasty. A priest of Perabsen, named Shera is known, see the next reign.

II. 5. SEND  about 4373-4332 B.C.

Although no contemporary remains of this king have been yet found, the tomb of Shera or Shery, a priest of Perabsen and of Send, was formerly at Saqqara; portions of its sculptures are now scattered at Oxford, Florence, and Cairo. There are also two priests of Send, named Aasen and Ankef (stele at Aix, Provence, S.B.A. ix, 180). And there is also a bronze statue made in the XXVIth dynasty (Berlin).

II. 6. KA-RA  about 4332-4315 B.C.

The only contemporary object which can be attributed to this king is the steatite cylinder found at El Kab (Q.K. xx, 29), which appears to bear the name Ra-ka; but as no cartouche is known at so early a date, there is some doubt about this. This is probably the reign stated as over 16 years 2 months 23 days on the Palermo list (S.A. 29).



FIG. 18.—Seal of Ka-ra.

II. 7. NEFER-KA-RA ☉ ♂ □ about 4315-4290 B.C.

No mention of this king occurs, except in Sety and Manetho's lists; in the latter is the legend that the Nile flowed with honey during eleven days.

II. 8. KHA-SEKHEM, SEKER-NEFER-KA ☀ ♂ about 4290-4242 B.C.

Seated figures, Oxford, Cairo (Q.H. i, xxxix, xl, xli).

Stone vases, Oxford, Philadelphia, Cairo (Q.H. i, xxxvi, xxxvii, xxxviii).

Stele, Cairo (Q.H. ii, lviii).



FIG. 19.—Figure of Kha-sekhem.

This king is only known from his monuments at Hierakonpolis, and his place in the list is uncertain. He doubtless preceded Khasekhemui, though some suppose that it is an earlier name of the same king. And he is more likely to be next to Khasekhemui than to be the same as Send, Ka-neter, or Nefer-ka-ra.

The seated figures are, one in slate, the other in hard limestone. Around the base of each figure is a row of slain enemies, and on the front is the inscription "Northern Enemies, 47,209." At this age Egypt was fairly consolidated, and these can hardly be of the Nile valley; nor are they likely to be Sinaites, as such are not termed northern; so probably these were a body of Libyans invading the Delta, and thus enemies in the north. This would accord with troubles of a Libyan revolt recorded in the next reign but one. It is even possible that this king and the next really belong to the following dynasty, and so this war might be that named by Manetho; but it is unlikely. The art of these figures shows a complete mastery of sculpture, the face being more delicately modelled than almost any later work.



FIG. 19A.—Inscription of Kha-sekhem.

The three stone vases are of alabaster, granite, and a piece of a pan of alabaster, all of large size. They all bear the same inscription: "The year of fighting the northern enemy, within the city of Nekheb the goddess Nekheb grasps the rebels (*besh*), and unites Egypt before the Horus Kha-sekhem" (Fig. 19A).

The piece of a stele shows part of a kneeling captive on a platform, which ends in the head of a foreigner

with a bow placed upon it. Below that is the name of Kha-sekhem, "humbling the foreign lands."

Sesokhris is stated by Manetho to have been 5 cubits and 3 palms high, which would be about 8 English feet, if the short cubit of 17.4 inches were used.

II. 9. KHASEKHEMUI   about 4242-
HEZEF . . . 4212 B.C.

Tomb, Abydos (P.R.T. ii, 12-14; lxiii).

Granite gate jamb, Hierakonpolis (Q.H. i, pl ii).

Inscribed block, Hierakonpolis (Q.H. ii, xxiii).

Diorite vase (F.P. Coll.).

Porphyry vase, Oxford (Q.H. ii, lix, 8).

Clay sealings (P.R.T. ii, xxiii, 191-218).

Daughter (?), Hapenmaat (P.R.T. ii, xxiv, 210).

The place of Khasekhemui is suggested by the presence of a seal of Hapenmaat, who seems to have been the queen-mother of the IIIrd dynasty; and Khasekhemui may well be, therefore, the last king of the IIInd dynasty, or possibly the first king of the IIIrd. The last king is named Kheneres by Manetho; and as Hezef . . . seems to be his personal name, Kheneres is probably his *ka* name. This might easily be a corruption of Khamerui, if the *sekhem* sign was mistaken in later time for the chisel *mer*.

His tomb differs entirely from all others. It is altogether 223 feet long, and 54 feet across at the widest. It consists of three parts: at the north is a door leading to three rows of chambers, thirty-three in all, for offerings; then comes a sunken stone chamber, with three chambers on either hand above it; and then seven chambers on either hand lead out to the south door. In these chambers were stored vases of stone and of copper, tools of flint and of copper, large jars of pottery, basket-work, stores of grain, etc. The sceptre of sard and gold was found in the tomb (P.R.T. ii, 27).

The central chamber of stone is the oldest stone building known. It is over 10 x 17 feet, and nearly 6 feet deep, the stone faces partly natural cleavages, partly wrought by hammer and by adze. Such work would naturally precede the building of a stone palace,

which is attributed by Manetho to the second king of the next dynasty.

Beside this building at Abydos there was found a great granite jamb for the temple gateway at Hierakonpolis, with the double *ka* name surmounted by Horus and Set, and with the group of *ankh dad was* up the side (Q.H. i, pl. ii).

Stone vases of this reign are very seldom inscribed; one porphyry fragment from Hierakonpolis bears the single name, and one diorite fragment with the double name was probably found at Abydos.

The clay sealings are the most important material in this reign. In every case the name is surmounted by both Set and Horus; face to face where the name is of the full form, both the same way where the shorter form is used. The shorter name Khasekhemui means "the glory, or the crown, of the two powers," and may refer either to the rule of Upper and Lower Egypt, or to Set and Horus, the gods of those divisions. The fuller name adds, "the two deities in him are at peace," or reconciled. The union, therefore, of the two tribes of Horus and Set worshippers was a special work of this king; and it may well be that it was a counterpart of the great fight with the western invaders which had occupied his predecessor. That there had been a rivalry during this dynasty is shown by Perabsen having a Horus-name and a Set-name. Many of the sealings refer to the royal vineyards (191, 192, 193, 196, 202, 204). Some name the vineyards of the "Red house" (191), the palace of Lower Egypt. The "Chief recorder of provisions under the king" appears, as under Perabsen (195); the "Recorder of provisions of the palace" and "the sealer of all things securely" (201); naturally, most of these seals refer to the royal provisions, as they only come from the jars of offerings deposited in the tombs. The most important seal (A.Z. xxxvi, 143) is that of "the sealer, constructor



FIG. 20.—Bowl inscription of Khasekhemui.

(architect) of the king-bearing mother Hapenmaat, who orders all things that are done for her" (210). This title "the king-bearing mother," *mut suten-mes*, is peculiar, and points to Hapenmaat being specially the ancestress of kings. She was adored at the close of the IIIrd dynasty, as Amten offered "a hundred loaves every day in the *ka* house (chapel) of the king-bearing mother Hapenmaat" (L.D. ii, 6). Hence it seems that she was probably the heiress of the IIrd dynasty, through whom descended the legitimacy of the IIIrd dynasty; similar to the special honouring of Neit-hotep with a *ka* name of her own, the ancestress of the Ird dynasty, or like Aahmes Nefertari worshipped during the XVIIIth dynasty.

The birthday of Khasekhemui is named as the event of one year on the Palermo stone (S.A. 27).

This whole dynasty shows a very different fashion to that of the Ird dynasty in every respect, especially in the worship of Set, at last placed on exact equality with Horus. With this closes the Thinite dynasties of Abydos, and it is to Memphis that the power gravitated for some centuries to come.

THE THIRD DYNASTY

	MANETHO.	LISTS.	MONUMENTS.	YEARS.	B.C. about
	O	Zazay	O		
1	Nekherofēs	Nebka	Sa-nekht, Nebka	28	4212
2	Tosorthros	Zesersa	Neter-khet, Zuser	29	4184
3	Turis	O	O	7	4155
4	Mesokhris	O	O	17	4148
5	Soufis	O	O	16	4131
6	Tosertasis	Zeserteta	O	19	4115
7	Akhēs	Sezes	O	42	4096
8	Kerferes	Neferkara	Huni	30	4054
9	Sifouris	Sneferu	Sneferu	26	4024
					3998

The adjustment of the monumental lists to the IIIrd dynasty of Manetho is not well fixed. The only well-attached points are Zesersa with Tosorthros, and Zeserteta with Tosertasis. But while there are three kings between Neferkasekru and Zeser in the lists, there are but two between Sesökhريس and Tosorthros in Manetho. On the other hand, Manetho places three kings between Tosorthros and Tosertasis, where the lists give no intermediate names. Again, at the close, there can be no doubt that Sneferu is Sifouris, and probably Neferkara is Kerferes, yet these are inverted in Manetho. Did we not know how well Manetho accords with the monuments where we actually have them, in the Ist dynasty, we might be tempted to abandon his text as corrupt here; but on the whole it seems safest to adjust all the statements together, as is done above.

Of Zazay nothing whatever is known beyond the lists of Abydos and the Turin papyrus, with the corrupt form Beby at Saqqara. Such a name—the chief, or head-man—is very likely for the founder of a dynasty; but it is conceivable that it originated from a title of Nebka, as the head or first of the dynasty, and then the title and the man were made into two separate kings.

III. I. SA-NEKHT,     about 4212-
NEBKA     4184 B.C.

Tomb, Beit Khallaf (G.M. pls. xvii, xviii).

Clay sealings (G.M. pl. xix).

Scarabs (P. Sc. 2-10; F.S. 6; restored, P. Sc. 1931).

The identity of Sa-nekht with Nebka is suggested by his place being apparently next before Zeser, judging by the form of his tomb; and this may agree with a fragment of a sealing of his which shows apparently part of a short cartouche ending in *Ka*; though as a cartouche is otherwise unknown till the end of this dynasty, there is some hesitation at recognising one here.

The tomb of Sa-nekht at Beit Khallaf is a brick mastaba, over 200 feet long by 80 wide. It contains two descending stairways, leading to two different groups of chambers, which are cut in the gravel. The main group has a horizontal passage below, with three small stone chambers on either hand.

In the tomb were alabaster vases and copper tools; also pieces of clay sealings, from which the name Sa-nekht is read, and perhaps also a cartouche Nebka (G.M. xix, 7). The few titles that can be read are "Director of the granaries" (7); "Anubis on his shrine, the good god commanding life" (11); the names Anpuhotep and Sekhem mery māat (11 and 22, 23); and perhaps a title "the follower of the crown" (6).

Some scarabs bear the name Nebka (B.Mus. and



FIG. 21.—Scarabs of Ra-nebka.

Sayce), and others Ra-neb-ka, which is the form of this king's name in the Saqqara list (B. Mus., P. Mus., H. Coll., F.P. Coll.). All of these are very simple in work, and some have an early form of the *Ka* sign with loops instead of hands. They are mostly of blue or green pottery, like the early amulets of

the first dynasty. In the instance where Psamtek in the XXVIth dynasty restored this king's name (like the restorations of the coins of earlier Roman emperors by the later), the form and style are entirely different from these small and plain scarabs, which there is no reason for not assigning to the time of this king.

The name in Manetho, Nekherofes, might be a version of Neb-ka-ra. The statement that the Libyans revolted, but submitted again owing to an unexpected increase of the moon, is probably due to some misunderstanding of early hieroglyphs. Very possibly *renp*, "year," named with the moon sign of month, was mistaken for *renp*, "increase." Two pieces of a tomb from Abusir mention a priest of the temple of Nebka (L.D. ii, 39, a, b).

III. 2. NETER'KHET,
ZESER



about 4184-
4155 B.C.

Tomb, Beit Khallaf (G.M. pls. vi, vii).

Doorway of glazed tiles, Saqqara (L.D. ii, 2 f; V.S. 37 A to D).

Sinai rock inscription (Rec. xvi, 104).

Sehel, stele (late) (B.S.J.; M.I. i, 78).

Clay sealings (G.M. pls. viii-x).

The tomb of Neter'khet at Beit Khallaf is a large mastaba of brick nearly 300 feet long by 150 feet wide, and over 30 feet high. Within it is a long passage descending from the top, barred by five great portcullis blocks of stone leading to a wide horizontal passage, and a dozen chambers at the bottom, which is over 50 feet underground. A great quantity of broken stone vases, nearly all of alabaster, were found inside, but not one was inscribed; and the only identification of the builder is from the clay sealings.

Another great tomb associated with Neter'khet is the step pyramid of Saqqara, two of the chambers of which were lined with glazed tiles, with an intermediate doorway of the same bearing this king's name and titles. Since the discovery of glazed wall tiles at Hierakonpolis and Abydos, it is certain that such were used even before the Ist dynasty; and there is nothing to throw doubt on the early age of this doorway, especially as no such tile work is known of the XXVIth dynasty. The writing of *māa* on the tiles, which has been stated to be late (A.Z. xxx, 4), belongs to the IIIrd dynasty (see Fig. 23). It is certain that Neterkhet bestowed most splendid work on this step pyramid, far finer than that of the tomb at Beit Khallaf (V.S. 37 A to D).

Now there are various explanations of there being apparently two tombs of this king. Most likely he built the step pyramid for his tomb, but owing to dying in Upper Egypt the mastaba was made for his actual burial; or the step pyramid may have been his tomb, and the mastaba for the queen, like the tomb of Mena at Abydos and that of Neit-hotep at Naqada; or the step pyramid may have been for the sacred Apis, who

was adored then, as his worship was established by Kakau, and the queen is named Hapenmāat ("Truth

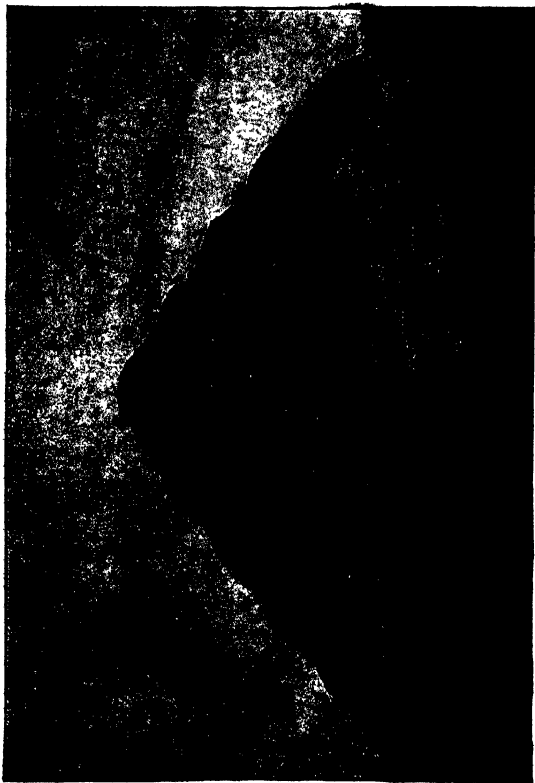

FIG. 22.—Step pyramid of Saqqara.

is from Apis"), if so, the mastaba was the king's tomb; or two tombs may have been deliberately made for the

king, as there are two pyramids of Seneferu. Perhaps a careful study of the inside of the step pyramid may clear up its history.

At Sinai, among other early royal names, that of Neter-khet has been found (Rec. xvi, 104). And at Sehel, at the first cataract, a rock inscription was put up in Ptolemaic times, as a pious forgery, professing to belong to Neter-khet-Zeser (M.I. i., 78); thus in late times these two names were believed to belong to one king, the only other evidence now known for that being the statue at Berlin (A.Z. xxxviii, 117).

Many of the sealings belong to the vineyards of the king (G.M. ix, 4, 5, 6; x, 12); others name Kharya, a priest of Upuat (1), also called "the king's beloved, who daily adores the god Anpu of Ut, who is in the fortress of Neru-tai" (2); the scribe Nez-neteru (3 a); the scribe of the desert Ra-khuf (3 b); the scribe Hotepun (9); the scribe of Memphis, Aha-en-ankh (11); an orator Iriken (13), and others. The frequency of scribes marks a later stage than that of the court in the earlier dynasties.

Of later reference to this king there is a statue of Usertesens II. adoring him (in Berlin); a priest of his, Senbef, in the XXVIth dynasty (L.D. iii, 276 c); another priest Aahmes of the same age (A.Z. xxxviii, 117); a chief of workmen, Khnum-ab-ra, of the Persian period, begins a genealogy from the time of Zeser (L.D. iii. 275 a); and this king is also named in a tale of the Westcar papyrus. Manetho records that Tosorthros was called Asklepios for his medical skill, that he built a palace of hewn stone, and that he favoured writing. These notices well accord with the beginning of stone building in the tombs two reigns before, and the great increase of scribes shown by the sealings.

Of Turis, Mesokhris, and Soufis there is no trace in any of the lists or monuments. The names have such an echo of those of Soris, Sesokhris, and Soufis, of the dynasties before and after this, that some duplication seems likely.

Zeserteta is given in each of the lists, and in Manetho, but no monuments of his time are known; a statue of Aahmes, a priest of his, is in Berlin (A.Z. xxxviii, 117).

Sezes, of the list of Abydos, seems to be equivalent to Akhes, of Manetho, by his position; but no remains are known belonging to this reign.

Neferkara, of the Abydos list, appears to be the same as Huni, found in the list of Saqqara, the Turin papyrus, and the Prisse papyrus, but nothing contemporary with him is yet known.

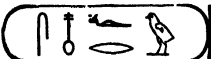
III. 9. SNEFERU  about 4024-3998 B.C.

Temple and pyramid, *Kha*, at Medum (P.M. 5-11).

Rock tablet, Sinai (L.D. ii. 2 a).

Diorite bowl, Gizeh (F.P. Coll.).

Granite bowl, Erment (Wiedemann Coll.).

Stone bowls, El Kab (Q.K. 4, 5, 19).

Diorite bowl, Cairo Mus.

Vase lid, Cairo Mus.

Palermo stone (S.A.).

Queens { Mertitefs; statue (Leyden Mus., C. R. i, 4, 5).
Merisankh?; pyramid, Medum.

Daughter, Nefert-kau; tomb of Snefru-khaf (Gizeh).

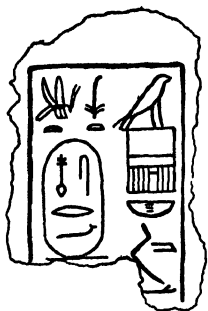

FIG. 23.—Vase lid of Sneferu (C. Mus.).

With the reign of Sneferu we reach firm ground historically, his own monuments and those of his subjects being well known. The royal domains seem to have lain about forty miles south of Cairo, at Medum, as the pyramid is there, and near there was the town Ded-Sneferu. The pyramid of Medum has been the subject of strange suppositions,—that it was a rock cut into shape, that it had no passages, that it was externally a step pyramid, etc. The tombs near it have been assigned to the XIIth dynasty, in spite of the

most obvious resemblances to the earliest work of the IVth dynasty. Recent researches have cleared away such speculations (P.M. 5-11).

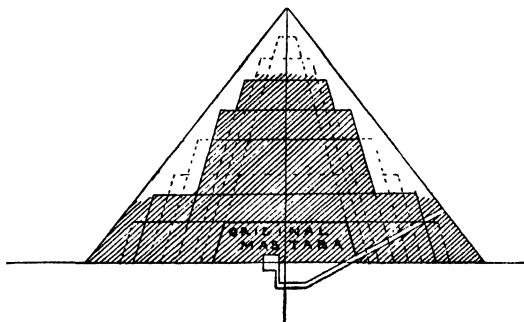

FIG. 23A.—Section of pyramid of Medum. Scale, 1 inch to 200 feet.

The primitive form of the sepulchre of Sneferu was a square *mastaba* (Fig. 23A), that is, a mass of masonry, flat-topped, with sides slanting inwards at about 75° or 1 in 4. The entrance was in the lower part of the north face. To enlarge this tomb a coating of masonry was put over it, as was often done in brick to the tombs of this age. The original mass was also carried upward, and thus a step resulted on the outside. This same process was repeated seven times, resulting in a compound pile, of which the top surface of each coat formed a great step on the outside. The outline thus became pyramidal, and the last process was to add

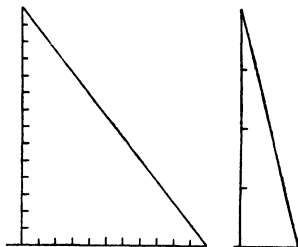

FIG. 23B.—Pyramid angle, 14 on 11;
mastaba angle, 4 on 1.

one smooth casing in one slope from base to top, and so carry it up to a point at the pyramid angle 14 on 11 (Fig. 23B). Two of the casings having been partly removed for stones, have left the mass inside of them standing up in a towering form. This is the earliest pyramid known, as the step pyramid of Sakkara is not a true pyramid, but a mastaba which was repeatedly enlarged, and was never coated over in one slope; thus it was never finished into a pyramid like that of Medum.

The successive enlargements of the pyramid of Medum have led to a theory being started, that all pyramids were similarly enlarged by coats during the kings' lives; but no other pyramid has this peculiarity. That of Menkaura at Gizeh has once been enlarged before it was finished, but no such system of building was followed, and in several cases the details of arrangement prove that the full size was planned from the first.

The interior of the Medum pyramid is reached by a long passage sloping down from the north face; in the rock under the centre it runs horizontal for a short way, and then turns upward as a vertical shaft, opening into the floor of the sepulchral chamber. This chamber is built on the surface of the rock, and is roofed by nine overlapping courses of stone. In the chamber, and the passage beneath it, were found pieces of the wooden coffin and a wooden jar, all broken and wrenched into splinters (F.P. Coll.). The wooden beams supporting the shaft lining are still sound and firm, being saturated with salt from the rock.

Outside of the pyramid, against the middle of the eastern face of the casing, was built a courtyard and chambers, forming a small temple. In this courtyard stood an altar for offerings, between two tall steles, without any inscription. On the temple walls were graffiti dating from the old kingdom to the XVIIIth dynasty; five of these mention Sneferu as the king to whom this pyramid was attributed. And the styles of the pyramid, the temple, and the tombs are in every

respect distinctly more archaic than the works of any later period, so that there is no possible ground to throw doubt on this repeated testimony. The temple is as plain as possible (Fig. 23C); no stone is used but limestone, and there is not the slightest ornament or decoration in any part of it. The walls were built in the rough, and trimmed down afterwards. A peribolus wall enclosed the pyramid and temple; the entrance to it was on the east side, leading to the temple; and the approach to it was by a causeway, walled on either hand, leading up from the plain.

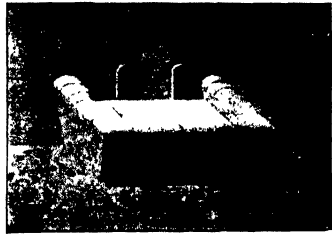

FIG. 23C.—Pyramid temple of Medum.

It appears that Sneferu had two pyramids; at Dahshur is the tomb of certain keepers of his pyramids; Dua-ra, keeper of the two pyramids named *Kha*; and also Ankh'ma'ra, keeper of the two *kha* pyramids of Sneferu (M.A.F. i. 190), one being distinguished as the south *kha* pyramid.

The worship of Sneferu was maintained constantly. His priests and adorers were:—

Amten	Early IVth dyn.	Tomb, Abusir (Berlin, L.D. ii, 5).
Henka	" " "	Statue, Medum (Berlin, B.C. 51).
" " "	" " "	Tomb, Dahshur (M.F.D. 12).
Dep'em'ankh	Vth "	Tomb, Saqqara (M.M. 198).
Thentha	Vth? "	Tomb, Dahshur (M.A.F. i, 191).
Dudu	XIIIth "	Dedication on base (M.A. 587).
" " "	XVIIIth "	Stele, Leyden.
Imhotep	Ptol.	Coffin, Louvre (B.T. 1256).
" "	" "	Stele (B.Mus. No. 380).

The only great royal inscription is that of the tablet in Sinai. It is headed by a cartouche containing the whole of the royal titles and name: the order of which differ remarkably from later usages, reading "(The

King of Egypt, lord of the vulture and uraeus, *Neb maât*, the Golden Horus, Sneferu). The Horus *Neb maât* (*ka* name) Sneferu, great god, giving all power, stability, life, health, expansion of heart, for ever. Subduing the countries." The king is seizing on a Bedawi (marked by his thin, narrow beard), and preparing to smite him with a mace. A scarab of Sneferu in lazuli (M. Coll.) is probably of the XXVth dynasty, from the material and style.

Of the events of the reign, some are preserved in the fragment of the annals on the Palermo stone. In the XIIIth year a great ship of 100 cubits was built, and 60 lesser ships. There was a Negro war in which 7000 people and 200,000 cattle were taken; and 40 ships of cedar were brought. In the XIVth year another cedar ship of 100 cubits was built. In the XVth year the great cedar doors of the palace were set up (S.A.).

Although it is doubtful if Khufu was the son of Sneferu (and De Rougé has remarked that none of the early kings appear to be sons of their predecessors), yet the family of Sneferu continued to the fourth generation. At Gizeh, on the hill-edge south-east of the pyramid of Khufu, is a tomb of Sneferu·khaf, whose father, Nefer·maât, was son of Nefertkau, the daughter of Sneferu. A queen of Sneferu was named Mertitefs; her statue is at Leyden, and a tablet of hers was found at Gizeh (M.M. 565). The type of face is very curious (see Fig. 23D, and for the whole group see C.R. 4, 5), belonging to a very marked race, to which may also be referred two early statuettes at Gizeh, and the scribe of the Louvre. Thus a royal wife might be of the inferior race, and not of the high type. Her inscription helps in determining the succession, as she was a favourite of Sneferu and of Khufu, and attached to Khafra in her old age. Hence there is no room for Radedef between these kings; and he must have been either a co-regent or a successor. Another queen is named, apparently as a wife of Sneferu, at Medum in a temple graffito of the XVIIth dynasty (P.M. 40). Her name, Meri's·ankh, is usually attributed to a queen

of Khafra ; but it is only stated as the name of a royal wife in the tomb of her son, the Prince Neb'em'akhet (Gizeh). If she were a wife of Sneferu in the end of his reign, her son might not be older than the reign of Khufu, and in his old age might therefore easily engrave in his tomb farm names compounded with the name of Khafra, which are the only indication of date in it. Thus it would not be at all impossible for her



FIG. 23D.—Upper part of statue of Mertitefs.

to be the wife of Sneferu. Or, again, she might have passed on to the harem of Khufu, as did Mertitefs, and her son Neb'em'akhet may not have been born till twenty years of the reign of Khufu had passed. There is therefore no sufficient reason to deny the accuracy of this statement of the XVIIIth dynasty graffito.

An inscription of the queen Merysankh is at Cairo Museum (R.E. ix, 77).

The private tombs of Medum probably belong to this

reign. The principal persons buried there were two royal sons, Rahotep, and his wife Nefert, and Nefermaât, with his wife Atet. Though entitled royal sons, they may not have been the immediate sons of Sneferu, but only descendants of some king. The only absolute sign of the age is in the name of a farm of Nefermaât, which is called Menat-Sneferu; but the whole style of these tombs is most closely related to the tomb of Amten (at



FIG. 23E.—Rahotep and Nefert (C. Mus.).

Berlin), and the tomb of Merab (at Berlin), which are both undoubtedly of the IIIrd or early IVth dynasty.

Rahotep and Nefert are well known from their incomparable statues in the Ghizeh Museum (Fig. 23E). These statues are most expressive, and stand in their vitality superior to the works of any later age in Egypt. They were found in the tomb chamber, which—in-
violate when discovered in 1871—is now much injured.

The sculptures on the walls are quite worthy of a place by the side of the statues. The scenes (P.M. ix-xiv) are drawn with more vivacity and expression than in any tombs of succeeding dynasties. The tomb of Nefermaät (P.M. xvi-xxvii) is peculiar for a special experiment of his own; all the hieroglyphs and figures are deeply incised, and filled with coloured pastes, secured in place by undercutting and keying carved in the hollows. The details of faces were worked in the colours. The inlaying, however, is soft, and soon perishes by exposure, and by salt efflorescence. The drawing is very good, but lacks the expression of detail in the faces which are so finely rendered in the reliefs of Rahotep. The signs carved in these tombs are among the finest known; and they are of great value as pointing to the origin of the hieroglyphs, and to the state of civilisation in which they were adopted. The advanced state of architecture shown in the forms figured there is very remarkable; but it appears to be mainly taken from wooden forms, and illustrates the lateness of the adoption of stone building.

The cemetery of Medum has also provided many examples of a different mode of burial from that of the well-known Egyptian method. Instead of full-length burial, with coffins, head-rests, vases, and provision for a future life, the more usual method of burial at Medum is lying on the left side, with the knees drawn up, facing the east, and without any vases or other objects. This shows a diversity of beliefs, and probably also of races, at this period (P.M. 21).

Of other kings which may belong to the early dynasties, should be mentioned the following:—

NEFER-SA. Alabaster slab with Hor-nefer-sa in cartouche (F.P. Coll.). This name also occurs in a graffito at Hat-nub (Rec. xx, 72); and in the hieratic papyrus Bulak, No. 8 (Pap. Bul. i, 39).



FIG. 24.—Alabaster of Nefer-sa (F.P. Coll.).

KHA-BA. There is a sealing with this Horus-name, and the golden Horus *Art-sed-f* (F.P. Coll.).

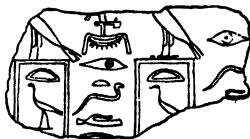

FIG. 24A.—Seal of Kha-ba (F.P. Coll.).

SAHU. A clay sealing with this Horus-name was found at Nubt (*Naqada*, lxxx, 1).



FIG. 24B.—Seal of Sahu (F.P. Coll.).

The close of the first three dynasties is a well-defined point in Egyptian development. Down to this age the character of work was more or less tentative. Although the main outlines of style were fixed in the times between Narmer and Zer, yet the IIrd and IIIrd dynasties are far from showing the style which prevailed later. The beginning of stone building in the IIIrd dynasty needed a couple of centuries of development before it could rise to its full grandeur under Khufu. And the growth of the use of stone superseded the wooden panels, which had served in earlier times to decorate the tombs of the great officials. At the close of the IIIrd dynasty we see the beginning of the system of stone offering-chambers in the mastabas, and observe the grand scope which they gave for decorative carving, as at Medum. This system led on to the immense wealth of sculpture which marks the IVth and Vth dynasties. In other respects later styles were growing: a few scarabs may be attributed to Nebka and Sneferu, though it may be questioned

whether they were contemporary with those kings. But in the IVth dynasty we begin the long series of scarabs which proceed with no great break throughout Egyptian history. The style of those bearing the names of the kings of the IVth and Vth dynasties is well marked; it agrees with the fine hieroglyphs of that age, and is entirely different to the style of the scarabs of any later time. There is, then, no reason to doubt that they show the rise of a fashion which, originating from the veneration of the beetle as in prehistoric times, became one of the most prominent of Egyptian customs.

The first three dynasties, so long in the dark, are now cleared up almost throughout, and we can trace the continuous development of the civilisation from the prehistoric times, more completely than in any other country, and see how it led up to one of the grandest periods of human activity.

CHAPTER III

THE FOURTH DYNASTY

	MANETHO.	LISTS.	MONUMENTS.	YEARS.	B.C about
1	Sōris	...	Shaaru	29	3998
2	Sufis	Khufu	Khufu	63	3969
3	Sufis	Kha·f·ra	Kha·f·ra	66	3908
4	Menkherēs	Men·kau·ra	Menkaura	63	3845
5	Rhatoisēs	Ra·ded·f	Radedf	25	3784
6	Bikheris	Shepses·ka·f	Shepseskaf	22	3759
7	Seberkherēs	Sebek·ka·ra	...	7	3737
8	Thamfthis	...	Aimhetep	9	3730
					3721

IN this list the order of Manetho is followed; but it does not always accord with that of the monumental lists. At Abydos Ra·ded·f is placed between Khufu and Khafra, but this is unlikely from the succession stated on the statue of Mertitefs. In the list of Sakkara, Sebek·ka·ra is placed between the end of the VIth or VIIth dynasty, and the end of the *inverted* XIIth dynasty. As there is not another instance of the names Seberkherēs or Sebek·ka·ra in any place, it seems possible that the designer of the Sakkara list in his evident confusion (inverting a dynasty) brought in Sebek·ka·ra in the place of Sebek·neferu, who should

hold that position at the end of the XIIth dynasty next to Amenemhat IV. The name Aimhetep is reasonably an origin for the form Thamfthis of Manetho; but his inscription in Wady Hammamat (L.D. ii, 115 h) does not perhaps seem so early as the end of the IVth dynasty: his name may therefore have been accidentally transferred from the end of the Vth to the end of the IVth dynasty, by Manetho or a copyist. The list of Abydos is more complete than that of Sakkara, which only gives the kings 1, 2, 3, and 5. No names remain in the Turin papyrus; for the numbers of frag. 32, usually set to this dynasty, have no connection with it; not a single reign corresponds with Manetho, and a name ending in . . . zefa shows it rather to belong to the XIVth dynasty.

IV. 1. SHAARU  about 3998-3969 B.C.

El Kab, Rock inscription (S.B.A. xxi, 109).

The beginning of the IVth dynasty has long involved a difficulty, as it seemed from the tombs and monuments that Sneferu was the immediate predecessor of Khufu. Recently, however, a new name, Shaaru, has been found at El Kab, incised on a rock in the desert, by the side of two cartouches of Khufu, exactly similar in style: no other names adjoin them. It is therefore clear that Shaaru was known at the same time as Khufu, and thus the name Sōris as predecessor of Khufu is fully explained; and Sneferu takes his place at the end of the IIIrd dynasty.



FIG. 25.—Inscription of Shaaru.

IV. 2. KHUFU

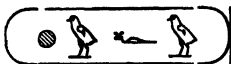
about 3969-
3908 B.C.Temple and pyramid, *Akhet*, at Gizeh (P.P.).

Rock tablet, Sinai (L.D. ii. 2 b).

Block, Bubastis (N.B. viii.).

Tablet, *Hat-nub* quarry (P.A. xlii.).Alabaster vases (Liverpool, L.D. ii. 2; Posno
Coll.; F.P. Coll.).Diorite bowl, *ka* name, Gizeh (F.P. Coll.).

Plummet, Gizeh (F.P. Coll.).

Weight (H.P. Coll.).

Scarabs. Plaque (see side).

Daughter, Henutsen. Tablet of Pasebkhanu
(M.D. 53).FIG. 26.—Plaque
(F.P. Coll.).

The great pyramid of Gizeh has made the name of Khufu, or Kheops, better remembered than that of any other king of Egypt; a fact which reverses the thoughtless verdict that pyramids are monuments of senseless ambition, and contradicts Sir Thomas Browne in his sentence that "to be but pyramidally extant is a fallacy of duration." Khufu has provided the grandest monument that any man ever had, and is by this means better remembered than any other Eastern king throughout history.

The great pyramid was set out from the first upon a vast scale, larger than any other pyramid; and it contains more stone than probably any other single building ever erected. Its base is far greater than the whole area of the great temple of Karnak, from Amenemhat to Ptolemy; its height is greater than any other building, except two or three slender towers of this century. Yet it stands as one of the earliest structures of the world (Fig. 27).

That it could not have been designed of any much smaller size is shown conclusively by the internal passages. The entrance to these would have been quite impracticable in design on any size of building not much over two-thirds of the present base. The actual size, moreover, shows that both this and the pyramid of Medum were designed to an exact dimension. The

most probable theory of its construction is that it was of such an angle that the height was the radius of a circle equal to the circuit of the base. This is so exactly the case, that it can hardly be questioned; and as the earlier pyramid of Sneferu has the same angle, it is evident that some attention was given to it. This angle is practically a rise of 14 on a base of 11 (as the ratio of radius to circle is closely 7:44); and hence the height of the pyramid should be divisible by 7, and the base of the side by 11. On looking at

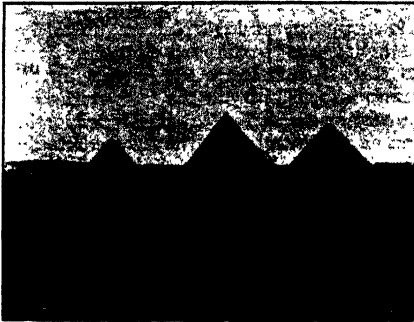

FIG. 27.—The Nine Pyramids of Gizeh from the south.

these two pyramids, we see that they were set out by a modulus of an even number of cubits. They measure —

Height . . . 7 } × 25 cubits in Sneferu's pyramid.
Base . . . 11 }

Height . . . 7 } × 40 cubits in Khufu's pyramid.
Base . . . 11 }

Such a simple and direct application of a similar design to each of these pyramids makes it very improbable that they had been enlarged hap-hazard to their final size without a clear design before arranged.

The pyramid was built of stone from the quarries on the opposite side of the Nile; both the fine casing and

the rough core must have come from there, as no such stone, and no equivalent quarries, exist on the west bank. The tradition recorded by Herodotus as to the labour employed, is so entirely reasonable for the execution of such a work, that we cannot hesitate to accept it. It is said that a hundred thousand men were levied for three months at a time (*i.e.* during the three months of the inundation, when ordinary labour is at a standstill); and on this scale the pyramid-building occupied twenty years. On reckoning the number and weight of stones, this labour would fully suffice for the work. The skilled masons had large barracks, now behind the second pyramid, which might hold even four thousand men; but perhaps a thousand would quite suffice to do all the fine work in the time. Hence there was no impossibility in the task, and no detriment to the country in employing a small proportion of the population at a season when they were all idle by the compulsion of natural causes. The training and skill which they would acquire by such work would be a great benefit to the national character.

The workmanship greatly varies in different parts. The entrance passage and the casing are perhaps the finest; the flatness and squareness of the joints being extraordinary, equal to opticians' work of the present day, but on a scale of acres instead of feet or yards of material. The squareness and level of the base is brilliantly true, the average error being less than a ten-thousandth of the side in equality, in squareness, and in level. The Queen's chamber is also very finely fitted, the joints being scarcely perceptible. Above that the work is rougher; the grand gallery has not this superlative fineness, and the construction of the King's chamber is flagrantly out of level, though its granite courses are fairly well wrought. A change of design is also shown by the shaft which has been cut through the masonry from the grand gallery to the subterranean parts; and also by the unfinished rough core masonry left for the floor of the Queen's chamber. Apparently the architect who designed and insisted on

all the fine work, died during its progress, and far less able heads were left to finish it.

That the entrance was closed by a hinging trap-door of stone is evident from the account of Strabo, and the remains of such a door to the south pyramid of Dahshur. The interior is so familiar in many books that it is needless to describe it here. The arrangement and number of chambers is entirely different from that known in any other pyramid; but from our ignorance of their former contents, it is almost useless to speculate about their purpose. The granite box-coffin in the King's chamber seems to point to that as the sepulchral chamber, especially as the great subterranean chamber in the rock was abandoned before it was cut out. The second high-level chamber, called the Queen's chamber, is said by Edrisi (1236 A.D.) to have contained then a second coffin; but no trace has since been seen of it. The great niche or recess in the east wall of the chamber seems as if it might be for the *ka* statue of the king.

The name of the king is found repeatedly written in red paint, among the quarry marks, on the blocks of masonry above the King's chamber; this establishes the traditional attribution of the pyramid. The chips and waste of the masons were thrown out around the pyramid to extend the platform on which it stands, thus forming extensive banks lying against the cliff, and stratified at the angle of rest. From these strata pieces of pottery, charcoal, and thread may be obtained.

Outside of the great pyramid extended a wide pavement of limestone, which on the east side stretched out to a temple which stood there. Of this temple no walls remain; but there are portions of a pavement of brown basalt, 190 feet long and 80 feet from east to west. Outside of this pavement are three deep trenches cut in the rock; these were lined with blocks of fine stone, and must have been originally about 160 feet long, 20 feet deep, and not over 5 or 6 feet wide. The purpose of such trenches is quite unknown; but there may have been some system of observing azimuths of stars by a surface of water at the bottom, and a cord stretched

from end to end at the top; by noting the moment of the transit of the reflection of the star past the cord, an accurate observation of azimuth might be made, and opposite azimuths of two stars (a polar and an equatorial) could be noted by an observer at each end of the cord. This is only a surmise; but it is one which would be in agreement with the accuracy of star observation shown by the orienting of the pyramid, and it would explain the peculiar form of these trenches. A fourth trench in the rock is but shallow, and has a steady fall down to the cliff edge. As it is worn by water, it was doubtless a drain for the washing of the pavement.

The worship of Khufu was maintained till a late period. The priests and keepers of the pyramid recorded are—

Ierab	Early IVth dyn.	Tomb, Gizeh (Berlin),	L.D. ii. 22 c
ʕa'em'nefert	" "	Tomb, Gizeh,	L.D. ii. 16
ʕhufu'ka'aru	" "	" "	L.D. ii. 17 d
ʕhemten	" "	" "	L.D. ii. 26
ʕa'y	" "	" "	L.D. ii. 34 b
'henthā	" "	" Sakkara,	M.M. 89
Hetep'hers	" "	" "	M.M. 90
Aimeri	Vth	" Gizeh,	L.D. ii. 50 b
Shepses 'kaf'ankh	" "	" "	L.D. ii. 53 a
Plah'bau'nefer	" "	" "	L.D. ii. 55
Dep'em'ankh	" "	" Sakkara,	M.M. 198
Snezem'ab'Anthā	" "	" Gizeh,	L.D. ii. 76
(Unknown)	VIth	" Shekh Said,	L.D. ii. 112 a-c
Ra nefer ab	XXVIth	" Ring, Abbott Coll., New York	
Psemtek menkh	" "	" Serapeum stele 314, Louvre	

The only great royal inscription, like that of Sneferu, is on the rocks of Sinai. There are two tablets: one with name and titles of Khufu, the other with the king smiting an enemy, and the name Khnum Khuf (L.D. ii. 2, b, c). This raises a difficult question, to which no historian has yet given a satisfactory answer. Who was this person designated as Khnum Khuf? Was he the same as Khufu, or an associated king? That he was not a successor is evident by the name being used indifferently with that of Khufu, in the

quarry marks inside the pyramid (L.D. ii. 1), and by his not appearing in any of the lists. The name is found in five places—the pyramid quarry works (L.D. ii. 1), the tablet of Sinai (L.D. ii. 2), the quarry of *Hat-nūb*, the tomb of Khemten at Gizeh (L.D. ii. 26), and two farm names of Shepseskafankh in Vth dynasty (L.D. ii. 50). In each of these places the normal cartouche of Khufu also occurs, except in the quarry; and the second cartouche differs in never being written with the two *u*



FIG. 28.—Rock tablet of Khufu, Wady Maghara.

signs; it is always Khnum-khuf, while the other name is Khufu. The addition Khnum cannot be merely a flight of orthography, as on the tomb of Khemten we read, “Lord of vulture and uraeus, Mezed (*ka* name of Khufu) (Khnum·khuf) Khent (Khufu)...” The two names being thus placed in succession in one inscription cannot be mere chance variants of the same. Either they must be two distinct and independent names of one king, or else two separate kings. If they were two separate kings, Khnum Khuf must have been the more

important (his name being first, and being that of the royal figure at Sinai); he must have lived through the greater part of Khufu's life (as the name was used in quarries when the pyramid was four-fifths built); and he must have died before him (as the name never occurs except with Khufu's). On the whole, it appears rather more likely that this was a second and wholly separate name of Khufu.

Another debatable question with regard to this reign is the tablet containing a reference to the sphinx, which has been often published and commented on (M.D. 53). The work of the tablet is wholly unlike that of the IVth dynasty; and it is generally agreed that it was executed in a late period. It was found in the small temple beyond the small pyramid south-east of the great pyramid. This temple was built by Pasebkhanu of the XXIst dynasty; and this tablet was carved probably under him, or some successor of his. The whole value of it turns on the question, then, whether it is an exact copy of an earlier tablet engraved by Khufu. This can only be judged by the character of it. In the first place, we have no such series of figures of gods on any existing monuments of the old kingdom; and Osiris, Isis, and the child Horus, which are mainly figured on this tablet, are rarely mentioned in early times, but are very common later. Osiris is called "lord of Rustau," a title not found in early times, but used by Pasebkhanu in this temple; and the tablet is full of instances of late writing, such as serpent determinative, *nen*, etc., which are unknown in early use, but are common later on.

The subject of the inscription, a statement of the searching for, or discovery of, certain buildings by Khufu, is suspicious. It is just what would be very likely to be put up in order to attach a credit and a history to those temples—like the common recital of the discovery of papyri under early kings. Moreover, we have seen that it is very doubtful if any masonry existed in Egypt before Tosorthros, "who built a house of hewn stones" in the IIIrd dynasty. And how then

could Khufu have needed to search for buildings erected not long before his time? Also, it is implied that there were temples of Osiris and Isis here before Khufu, which is very improbable, as there is no sign of earlier remains at Gizeh before Khufu selected this site of open hill-desert, Sneferu having built far away from Gizeh. Again, the figure and mention of the Sphinx and its temple is prominently introduced; whereas there is no other trace of the Sphinx, or any temple or worship connected with it, among the dozens of various priesthoods, or the hundreds of tombs, of the old kingdom. Further, what chance was there of such a tablet of Khufu remaining until the XXIst dynasty to be copied, and yet not being itself set up in the temple? In every direction, then,—style, figures, and subject,—there are very suspicious details about it; and it is impossible to accept this as certainly an exact copy of a work of Khufu. The references to the positions of buildings, then, have no higher authority than the beliefs of the XXIst dynasty. The localities stated are a temple of Isis near the pyramids of Khufu and his daughter Henutsen, a temple of the Sphinx south of that, and a temple of Osiris south or south-east of the temple of the Sphinx. The temple of Isis would seem by the position to be the place of the temple of Pasebkhanu where this tablet was found, and the reason of carving such a tablet, to give a credit of great antiquity to the place, is obvious. Of the temples of Osiris and of the Sphinx nothing whatever is known. The granite temple is clearly as late as Khafra,—as we shall see presently,—and hence could not possibly be a temple found by Khufu. The only point that can be identified is the very place at which this tablet was required to give the sanctity of age to a new building.

The need of fine stone for the advancing luxuries of architecture led to the discovery and working of the alabaster quarry, as much as ten miles from the Nile, behind Tell el Amarna. There Khufu began by cutting a wide, gently - sloping road, descending into the

plateau, to reach the rock-masses of alabaster; and the cartouche *Khnum Khuf* and *ka* name, cut as his sign of possession on the rock, have stood open to the day ever since. This quarry was that well known as Hat-nub in the later inscriptions; it was used during the old kingdom, and was probably the source of all the alabaster building and vessels of that age. In the middle kingdom an adjacent quarry was opened, and others during the empire. Alabaster vases of Khufu are known (Liverpool and Posno Coll.), and a piece of one was found at Koptos (F.P. Coll.).

At Bubastis, a granite block with a largely sculptured *ka* name of Khufu points to his having executed some great building here; and this early work is confirmed by an adjacent block of Khafra.

It has been stated that Khufu erected an obelisk (W.G. 178, 185), but this is a mis-reading. The real passage is, that Merab (L.D. ii. 22 c) was *Ur maa*, or high priest, of Heliopolis (as Rahotep was at Medum, P.M. xiii.), and also priest of Khufu; the obelisk, or rather column, merely occurs here as a sign in writing the name of Heliopolis, and has nothing to do with Khufu.

There are many tombs of great persons with the title "king's son," some being grandsons of kings, as Merab (L.D. ii. 20, 21), whose mother was a king's daughter, but not a king's wife. Hence it is impossible to settle the parentage of these persons, or to which king they should be referred. These being, then, without direct historical connection, we cannot here refer to them, except when they held royal priesthoods or other such offices. A weight bearing the name of Khufu carries back the gold standard of 200 grains to his time (H.P. Coll.).

The scarabs of Khufu are not very rare; from their workmanship, they are probably contemporary, excepting one of pottery made under Amenardus (G.M.). The plaque at the heading of this reign bears the earliest example of the winged disc (F.P. Coll.).

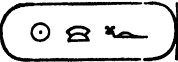
IV. 3. KHAFRA  about 3908-3845 B.C.

Temple and pyramid *Ur*, at Gizeh (P.P.).
 Granite temple and causeway (P.P.).
 Great statue and others, granite temple (G. Mus.).
 Alabaster statue, Sakkara (G.Mus.).
 Block, Bubastis (N.B. xxxii.).
 Name from a bowl, temple of pyramid (B.M.).
 Names on mace-head " (F.P. Coll.).
 Scarabs (B.M., etc.) Cylinder (F.P. Coll.).



FIG. 29.—Names of
 Khafra from a
 statue.

The pyramid of Khafra stands near that of Khufu, on the south-west. It has always been attributed to him by Herodotus and Diodoros, and by modern writers. The only monumental evidences are the pieces of a bowl and a mace-head with his name, found in the temple of this pyramid. But the sequence of position between the first and third pyramids makes this attribution unquestionable.

The pyramid is rather smaller than that of Khufu, inferior in accuracy, and of a worse quality of stone, both for core and for casing masonry. The lowest course, however, was of red granite, which did not appear on the outside of Khufu's pyramid; the entrance passage is also of granite. The site of the pyramid has been levelled considerably. At the south-east it is built up of blocks of rock; at the west and north it is deeply cut into the rock hill, leaving a wide space around the sloping mass of the sides, with a vertical boundary facing the pyramid. The lower part of the pyramid on these sides is undisturbed rock cut into shape; upon that lie a few courses of enormous rock blocks, cut out from the rock clearance around the

pyramid, and above that comes building of smaller blocks brought from the east cliffs. The casing still remains upon the top of this pyramid.

It had originally two entrance passages, one high on the face ; another leading out in the pavement in front of the face ; this was, and still is, blocked with masonry. The chamber is on the ground level, sunk in the rock, but roofed over with slanting beams of stone. The sarcophagus is of granite ; the lid was secured by under-cut grooves in which it slid, and was held from being withdrawn by bolts (of copper ?) which fell into holes, and were secured by melted resin, which still remains. The sarcophagus was sunk into the floor when Belzoni found it, and its lid lay over it, displaced : now the floor is all destroyed.

On the east side of the pyramid stood a temple. The vast blocks of rock which formed the core of the walls still remain ; and some of the granite casing of the interior is yet in place. It is encumbered with masses of chips, among which are pieces of the furniture of the temple, statues, vases, etc.

From this temple a causeway led down a line of the rock plateau, where a gradual and easy slope could be laid out. It is evident that this is a road of convenience, made exactly where it could be laid out with the best gradient, and distinctly not square with the pyramid or the temple, being about 15° south of east. It was doubtless the road up which all the material was brought for the building of the pyramid and the temple, like the roads belonging to the other pyramids. It was paved with fine stone, recessed into the rock bed.

This road led down to the plain, and must have been open at the end when the material was being taken up it. After the pyramid and its temple were finished, the road was utilised as a junction between the pyramid-temple at the top of it, which was built square with the pyramid, and another temple at the foot of it, which was built with a skew entrance in continuation of the road (Fig. 30). This is a point of great importance as proving the age of the granite temple. Both of these

temples are oriented square to the points of the compass ; but the road between them is askew for reasons of its construction, and the lower temple passage is all one with the line of the skew road. This skew passage has never been altered or adapted to the road after the rest of the temple was built ; for there are no signs of any reconstruction, and the doorway in the corner of the great hall is askew in the wall, so that it could not have been altered without pulling down all that end of the building. The courtyard on the top of the temple, and the stairs of access to the top, are also dependent



FIG. 30.—West side of granite temple, showing passages and causeway leading askew up to temple of second pyramid.

on this skew passage, which is built in one compact mass with the whole body of the temple. Hence the granite temple must be subsequent to the roadway and to the building and finishing of the pyramid and temple of Khafra ; and as his statues were found in this temple, the building of it may be almost certainly attributed to Khafra.

This granite temple—often misnamed the temple of the Sphinx—is really a free-standing building on the plain at the foot of the hills ; but it is so much en-

cumbered that it is often supposed to be subterranean. The upper part of it now consists only of the great blocks of inferior rock which formed the core of the

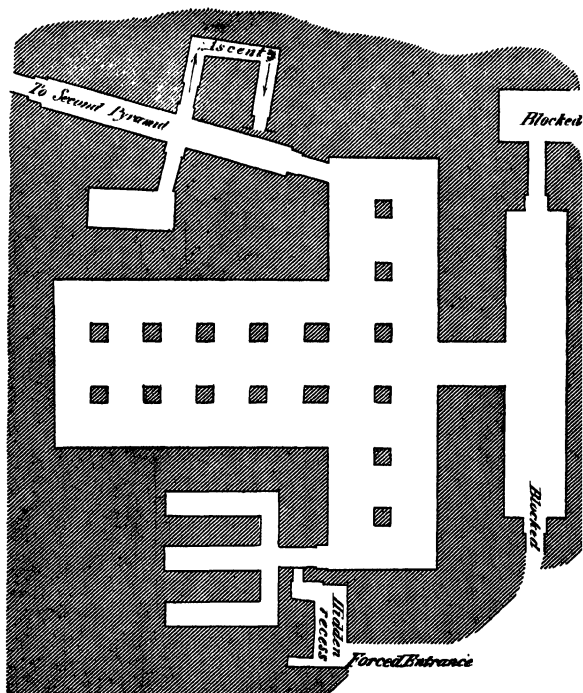

FIG. 31.—Plan of granite temple. Scale $\frac{1}{100}$.

walls ; but the lower storey of it inside is perfect, and outside of it the casing still remains, showing that it was decorated with the primitive pattern of recessing.

The origin of this pattern is unknown; probably it is derived from brick decoration, as it is found equally in the earliest brickwork in Egypt (Medum) and in Babylonia (Wuswas; see Loftus, *Chaldea*, 172-179). The whole of the surfaces inside are of red granite, or white alabaster (Fig. 31). The essential parts of it are a T-shaped hall with the stem toward the pyramid, and a long hall parallel with, and adjoining, the head of the T. From the T-hall opens a chamber with three long recesses, each divided into an upper and lower part by a thick shelf. These recesses are of alabaster, and from their form probably contained sarcophagi. This chamber, and one opening from the entrance passage, retain their roofs complete, with ventilating slits along the top of the wall. Over the T-hall was an open court, reached by a sloping way, which turns in the thickness of the wall, from the entrance passage. The long hall is higher than the T-hall, and had a large recess above each of the doors which occupy the ends of it. These recesses seem as if they might be for statues, as there is no access to them, and they were closed at the back, and so could not be for windows. The diorite statue of Khafra was found in this hall, thrown into a well, or subterranean chamber. This is now filled up, and no proper account was ever given by the explorers. The east side of the temple has not been cleared, and the structure of it further in this direction is yet unknown.

Near this temple stands the Sphinx (Fig. 32); and as there is no evidence of its age, we may consider it here owing to its position. Its whole mass, lion's body and man's head, is entirely carved in unmoved native rock, although the weathering lines give the head the appearance of built courses. The body has been cased with stone, and the paws of it are built up with small masonry, probably of Roman age. It must have been a knoll of rock, which ran out to a headland from the spur of the pyramid plateau; and the hardness and fine quality of the mass now forming the head had doubtless preserved

it from the weathering which had reduced the soft strata below that. When then was this knoll of rock so carved? And by whom? A later limit is given by the stele of Tahutmes IV. placed between its paws, which records a dream of his, when taking a noonday siesta in its shadow. It must then be much older than his time. On the other hand, it has been supposed to be prehistoric. But there is some evidence against that. In the middle of the back is an old tomb shaft; such would certainly not be made at a time when it was venerated, and it must belong to some tomb which



FIG. 32.—The Sphinx, side view.

was made here before the Sphinx was carved. And no tombs at Gizeh are older than Khufu, nor are any in this part of the cemetery older than Khafra. We may see this on looking at the wide causeway in the rock up to the second pyramid. On either hand of that is a crowd of tomb shafts, but not one is cut in the whole width of the causeway. In short, the causeway of Khafra precedes the tombs in the neighbourhood; but the Sphinx succeeds these tombs. Another consideration points to its being later than the old kingdom; there is no figure or mention of the Sphinx itself on a single monument of the old kingdom, nor do any priests of his appear. On the stele of Tahutmes IV. Khafra is alluded to, perhaps as the maker of the Sphinx; this connection was easily suggested by its nearness to his pyramid and temples. But how much Tahutmes knew of Khafra, or cared to

was made here before the Sphinx was carved. And no tombs at Gizeh are older than Khufu, nor are any in this part of the cemetery older than Khafra. We may see this on looking at the wide causeway in the rock up to the second pyramid. On either hand of that is a crowd of tomb shafts,

honour him, is shown by the material he selected for his tablet. It is carved on a grand door lintel of red granite, which almost certainly was robbed from the adjacent granite temple of Khafra. The devotion of Tahutmes to his predecessor was a fiction, and no more; and how much he knew of the works of Khafra may well be doubted. The real period of the Sphinx may be between the old and middle kingdom, to which age it now seems that we must assign all those sphinxes formerly attributed to the Hyksos.

The front of the Sphinx was a place of devotion in Roman times; and great brick walls were built to hold back the sand on the side next the granite temple. A wide flight of steps leads down to the front, where a Roman altar of granite stood before the shrine between the paws, which was formed of tablets of Tahutmes IV., Ramessu II., etc. This front of the Sphinx has been cleared three times in this century; but the back of it, and lower part of the sides, have never been examined.

Khafra was worshipped till late times, like the other great kings of this age. His priests and keepers of the pyramid were—

Thetha . . .	IVth dynasty	(L.A. 8, a, d)
Uash (his son). . .	" "	(L.A. 8, b, c)
Khafra'ankh . . .	" "	(L.D. ii. 8, 10, 11)
Nefermaat . . .	Dahshur	(M.A.F. i. 191)
Ka'em'nefert . . .	Vth dynasty	(M.M. 248)
Dep'em'ankh . . .	Vth dynasty	(M.M. 198)
Psamtek'menk	XXVIth dynasty	(Serapeum stele, 314)

Apparently some other great building of Khafra existed to the south of the Memphite cemeteries; for in the construction of the south pyramid of Lisht are built in some fragments of a lintel and walls, bearing the name of Khafra.

The statues of Khafra have brought us face to face with him, and caused his features to be almost as well

known in our times as in his own reign (Fig. 33). The great diorite statue is a marvel of art; the precision of the expression combining what a man should be to win our feelings, and what a king should be to command our regard. The subtlety shown in this combination of expression,—the ingenuity in the overshadowing hawk, which does not interfere with the front view,—the technical ability in executing this in so resisting a material, — all unite in fixing our regard on this as one of the leading examples of ancient art. Six other

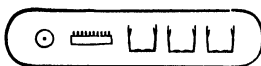

FIG. 33.—Khafra. Diorite statue. (G. Mus.)

statues of lesser size were also found in the granite temple, carved in diorite and green basalt. A smaller statue of fine work in alabaster was in the group of early statues lately found at Sakkara. All of these are now in the Ghizeh Museum. Fragments of diorite statues occur in the mounds of chips over the temple of the second pyramid. From this same place come a piece of an alabaster bowl with his cartouche

(B.M.), and a piece of a mace-head in hard white limestone, with *ka* name and cartouche (F.P. Coll.). A block of granite with the names of Khafra was found at Bubastis (N.B. xxxii.), showing his activity in the Delta. The earliest dated cylinder is of the reign of Khafra; it is rudely cut in greenish steatite, with a variant of the name “(Ra·en·khaf), loving the gods” (F.P. Coll.). His scarabs are not very rare.

IV. 4. MEN·KAU·RA



about
3845-
3784
B.C.

Temple and pyramid, *Her*,
Gizeh.
Pyramid, *Neter*, Abu Roash.
Small pyramid by *Her* py-
ramid, Gizeh.
Diorite statue, Sakkara
(G. Mus.).
Scarabs (B.M., etc.); cylinder
(sec side).

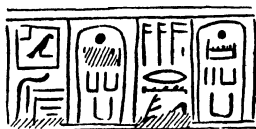

FIG. 34.—Steatite cylinder. $\frac{1}{2}$ scale.
(F.P. Coll.)

As in the case of Sneferu, we again meet with the strange occurrence of a king having apparently two pyramids. In the tomb of Urkhuu, at Gizeh, we find that he was priest of Menkaura, and keeper of a place belonging to the pyramid *Her* (L.D. ii. 43 d, 44 a). And Debehen, who was a high official of Menkaura, also mentions the pyramid *Her* (L.D. ii. 37 b, 1st col.), so that it is always recognised by historians as his pyramid. But Debehen goes on to say that he inspected the works of the Menkaura pyramid *Neter* (2nd col.). And Uta in the IVth (G. Mus.) and Dep'em'ankh (M.M. 198) in the Vth dynasty were priests of the Menkaura pyramid *Neter*. Hence it is probable that there were two pyramids; and they cannot belong to different kings called Menkaura, as Debehen names them together in his inscription, and

both cartouches are Ra·men·kau, thus excluding Ra·men·ka (singular), *i.e.* Netakert of the VIth dynasty.

This mention of two pyramids exactly accounts for the name being found at two places. The third pyramid of Gizeh has been attributed to Menkaura by Herodotos and Diodoros, and his name is found in one of the small pyramids by its side. But also a piece of a diorite statue—like those of Khafra—was found at the hill pyramid of Abu Roash, with part of the cartouche Ra·men·; and the casing and passage lining of the Abu Roash pyramid with granite was closely like the casing and lining of Menkaura's Gizeh pyramid with granite. The style of the statue and of the casing link the pyramid of Abu Roash to the middle of the IVth dynasty. Which of the pyramids was the final sepulchre we may guess; that of Gizeh is evidently in sequence with those of Khufu and Khafra, and was probably built first. But it was enlarged in course of building, and yet the casing is left unfinished. Finally, seeing that it was hopeless to rival the great structures of his predecessors, Menkaura seems then to have selected a new site at Abu Roash, where, on the highest hill of the western cliffs, a small pyramid might show with advantage. At Abu Roash it is that the funeral statue was placed, together with a granite sarcophagus, which has been destroyed. Following the sequence thus indicated, it seems that *Her* was the earlier pyramid—that of Gizeh; for there is no priest of the pyramid *Her*, and it is mentioned by Debehen before the pyramid *Neter*. On the other hand, Debehen names the pyramid *Neter* later, and there were priests of it in the IVth and Vth dynasties. *Neter* seems then to have been the actual sepulchre, and would therefore be the later pyramid—that of Abu Roash.

The pyramid of Menkaura, at Gizeh, is far smaller than those of his predecessors; and it is also far inferior in accuracy. But the masonry is good, and it is built in a more costly manner. The lower sixteen courses were cased with red granite, most of which

still remains; the upper part was of limestone, of which heaps of fragments now encumber the sides. The granite casing was quarried and brought to Gizeh with an excess of several inches' thickness on the face, the building joint-line being marked by a smoothly-worked slanting strip down the side of the stone, beyond which it rounds away. This excess has never been removed from the faces, and the pyramid was never finished. The interior differs from that of the other pyramids (Fig. 35). The present entrance is

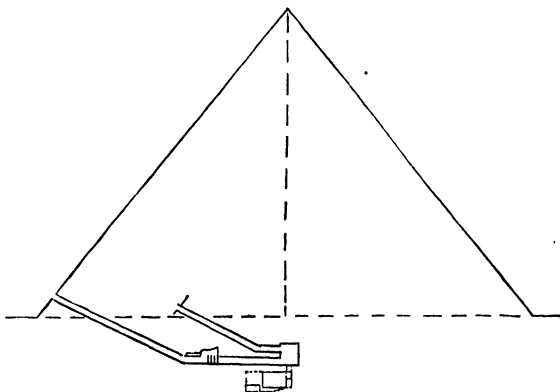

FIG. 35.—Section of the pyramid of Menkaure.

lower than the line of an earlier passage, which was disused when the pyramid was partly built. The early passage now opens on to the great chamber at a higher level than the present door, and it runs northward in the masonry until blocked by the outer part of the building. The lower passage is lined with red granite down to the rock, like the entrance of Khafra's pyramid. In the horizontal part in the rock are several port-cullises, and a small chamber, or enlargement of the passage, decorated with the early recessed pattern.

Beyond all this the large chamber is reached, entirely cut in the rock. The doorway of the earlier passage is now high up above the doorway of the later passage. The chamber has a recess in the floor, apparently intended for a sarcophagus; but another short passage descends in the midst of the chamber westward, and opens into a lower chamber in which stood the basalt sarcophagus, decorated with the recessed pattern of panelled doorways. This was removed by Vyse, and lost at sea. The lower chamber is lined with granite, built into a flat-topped chamber cut in the rock. The floor and walls are of granite, and the roof is of sloping granite beams, butting together, and cut out into a barrel roof beneath, like the barrel roofs of some of the early tombs at Gizeh. Some steps descend from the side of the passage to a small chamber with loculi. In the upper chamber was found the lid of a wooden coffin with inscription of Menkaura, and part of a skeleton, probably of a later interment.

From this, and considerations on other pyramids, it has been lately suggested that a great amount of reconstruction of the pyramids took place under the later kings of the renaissance,—about the XXVIth dynasty,—and that much of the present arrangements are due to them. This will be the best place to review such a theory. The strong points of it are that the inscription on the wooden coffin of Menkaura has some details which are unparalleled in any inscription so early; hence this coffin is probably a reconstruction. Next, the step pyramid of Sakkara has certainly been largely altered, and new passages made in it, probably more than once; the glazed tiles of the doorway in it are also considered by some to be late in date, but the most distinct point claimed for this is the writing of *maa* with the cubit inside the sickle, yet this is found also on the jar lid of Sneferu (G.M.), which is certainly early. The peculiar form of the granite sarcophagus of the pyramid of Illahun, with a lip around it, and a sloping base, is adduced as a sign that it was let into

the floor in the first construction, and that therefore the chamber in which it now stands is a reconstruction. The winding passage of the pyramid of Hawara, and the steps down the entrance passage, are also looked on as a reconstruction, and the original passage is supposed to have been direct from the north side to the middle of the chamber roof, the continuation of the trough in the floor of the upper chamber.

Now, there cannot be any question that there has been a re-use of some of the pyramids for sepulture, the small ushabtis of the XXXth dynasty in the pyramid of Hawara put this beyond doubt. Nor can we doubt that alteration has been made in some cases, as in the many passages of the step pyramid of Sak-kara. Nor is it unlikely that the coffin lid of Menkaura is a late restoration, especially as we have seen that it is probable that he was actually buried at Abu Roash. And in some cases it is certain that changes have taken place in course of building, as in Khufu's and Menkaura's pyramids.

The question, then, is one of degree. It can hardly be questioned that the idea of changes having taken place holds good in some cases; but how far have such changes extended? Is it conceivable that any king, for instance, could have made all the winding passages of the Hawara pyramid as a reconstruction? The great length of them, the series of blocking chambers with gigantic trap-doors in the roofs, the long, false passage blocked up, the dumb wells which lead nowhere, all these great works, if subsequent constructions, would have had to be built into a mass of loose bricks and sand, in which it is a great difficulty to run even a small drift-way, to say nothing of the great spaces required for such construction, and for executing work on such great masses. It would be more practicable to take down the whole pyramid before putting in such a mass of heavy masonry, and then re-erect it afterwards. Again, at Illahun, if the sarcophagus were originally let into the floor, the whole granite chamber must be a reconstruction, and

a gigantic work of reconstruction it would be, to introduce the whole of this masonry and form a new and secondary chamber beside the main one already existing.

If any such grand works of reconstruction had taken place, to whom can they be attributed? Certainly not to the XVIIIth or XIXth dynasty, for plundering was rather the habit then, as witness the sweeping away of the temple and shrine of Usertesen II. at Illahun by Ramessu II. (P.K. 22). The XXVIth dynasty, with its renaissance of the old ideas, is the only likely period for such attention to the older kings, as many priest-hoods of those kings were revived then. But if so, how is it that the restorers have not left a single trace of their presence? Over-modesty was not a failing of Egyptian kings in any age; usually they stamped out all remembrance of their forerunners in order to aggrandise themselves. Even the more reasonable kings always put up their names, and a statement of the rebuilding they had done, when they repaired a temple. Is it then possible to suppose that, after doing work comparable with the building of the pyramids, they should have sunk all trace of themselves? Not a hieroglyph, not a graffito, can be seen anywhere associated with these supposed reconstructions. Again, if they had spent such toil and cost upon the hidden interiors of the pyramids from a deeply religious veneration for the ancient kings, and appointed services of priests to adore them,—as we see by the priesthoods,—is it conceivable that they should never have provided any restoration of the old temples in which these priests could worship? Would the external buildings for the honour of the king, and the use of the priest, have been totally neglected, while a lavish grandeur of work was spent on the hidden interior? Yet there is no trace of reconstruction of the pyramid temples. The temples of Illahun were swept away by Ramessu II., as shown by objects of his time, and by his name scrawled on the stones, and no sign of reconstruction is to be found. The priests

must have adored at the pyramid in open air, while vast and needless granite work was being made inside the pile. At the temple of Khafra there is no trace of restoration; but the rubbish now filling it contains the relics of small objects, which would never have remained in use until a restoration three thousand years later. The present ruin must be the first and only one which has overtaken that site.

So far, then, from pushing the theory of reconstruction as far as possible, and explaining every little anomaly and change of design by that means, we meet with such serious difficulties in supposing this reconstruction to be important in either amount or extent, that it is needful to limit it firmly to such cases as are inexplicable on any other supposition. One instance which has not been actually adduced, but which seems at first sight a good case, is the late style of the figure of king Men·kau·hor, on a slab brought from his temple (reworked into the Serapeum), and now in the Louvre. The details of the figure, the vulture flying over it with the ring in the claws, the decoration of the kilt in front, all look certainly of late date, at least of the XIXth dynasty. But sculptures of Antef V. (XIth dyn.) and of Sebekhotep IV. (XIIIth dyn.) bear figures which are almost exactly the same, showing that what seems to be late may be far earlier than we suppose. And, moreover, the slab of Menkauhor has been reworked into a tomb, the hieroglyphs of which are certainly later in position than the figure of Menkauhor; yet these hieroglyphs can hardly be later than the XVIIIth dynasty, and are more probably of the XIIth. Thus in a case which at first sight seems good evidence of restoration by the XXVIth dynasty, we see reasons for setting aside any such hypothesis when we learn more of the facts. This may serve as a useful instance of the risk of rashness in applying theories too widely and generally.

Of the temple of Menkaura, only the outline of core blocks is now known; the granite casing and pillars having been removed in the last century.

Of lesser remains of Menkaura there is a statuette in diorite found at Sakkara (Fig. 36) (G. M.). The work is not equal to the statues of Khafra, but is better than that of some later statuettes found in the same group. It seems from the diversity and continual deterioration of the work, that these statuettes must have been executed under the kings whose names they bear. Unhappily they were found at Sakkara by Arab diggers, from whom they were bought at a high price for the Ghizeh Museum; and very contradictory statements have been

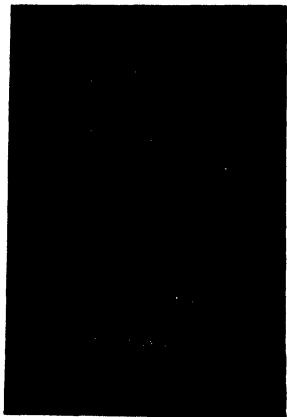

FIG. 36.—Statuette of Menkaura.

made as to their real source.

The second earliest cylinder known is of Men·kau·ra; it is cut in black steatite, and is of the same work as the small rude cylinders of black steatite which are of very early date, and appear to be substitutes for funereal steles. This bears the name “(Ra·men·kau) beloved of the gods (Ra·men·kau) Hathor . . .” (F.P. Coll.). The contemporary scarabs of Menkaura are rarer than those of either of his predecessors (Fig. 37); but his name was frequently used in later times. Hatshepsut made scarabs of him, and



FIG. 37.—Scarab of Menkaura, and restoration by Hatshepsut.

in the XXVIth dynasty his name is common on scarabs, cylinders, and plaques, found—and probably made—at

Naukratis, Marathus, and elsewhere. It is remarkable how correctly he is entitled on these objects, which appear to have been copied from some real scarabs of his time.

The prince Hordadef is said in the Book of the Dead to be a son of Menkaura; but this is not an earlier authority than the Westcar papyrus, which in one tale names Hordadef son of Khufu. As there is no other person Hordadef known, it is probable that this is a confusion of one person, whose date cannot be settled without contemporary evidence. It is possible that this is the same person as the next king, Ra·dad·ef.

IV. 5. RA·DAD·EF

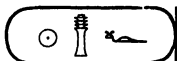

about 3784-
3759 B.C.

Scarcely anything is known about this king, and even his historic position is not certain. On the one hand, his name appears in the lists of Abydos and Sakkara, between Khufu and Khafra. But, on the other hand, he is omitted by Mertitefs, who recites her successive connection with Sneferu, Khufu, and Khafra (R.S.D. 37). Psamtek·menkh and Psamtek, his priests in the XXVIth dynasty, give the sequence in both cases as Khufu, Khafra, and Ra·dad·ef (R.S.D. 53). We can hardly refuse to recognise the Rhatoises of Manetho as Ra·ded·f; and here again the name appears after Khafra, and after Menkaura. There is a bronze cylinder of this king in the Poignon Collection (W.G. 187); but there are no other traces of him, except a priest Ptah·du·aau (R.E. 62) at Gizeh, a slab of another priest of his (G. Mus.), and a farm named after him in the tomb of Persen (R.S.D. 53, 54) at Sakkara. His pyramid is unknown.

IV. 6. SHEPSES·KA·F

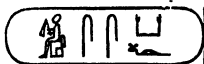

about
3759-3737
B.C.

Pyramid, *Keb*, site unknown.

Scarab (see side) ; cylinder (F.P. Coll.).

Eldest daughter, Maāt·kha.



FIG. 38.—Scarab
(F.P. Coll.).

The only list containing this king's name is that of Abydos ; and in that, and the few other monuments, his name is always thus written, but on a scarab it appears with *ra* added (see above). There may have been two forms of the name, as there were the two forms, Neb·ka and Neb·ka·ra, apparently both belonging to the same king ; and at Shekh Said Userkaf has *ra* added to his name, as Manetho also gives Userkheres (*i.e.* User·ka·f·ra) for User·ka·f. The name in Manetho, Bikheris, may possibly be a mutilated form of this name retaining only the *p·ka·ra*. Or else the Seberkheres, the next name on the list, might refer to this king ; but as the tomb of Ptah·shepses shows this noble to have lived through the reigns of Menkaura and Shepseskaf, it is less likely that the Rhatoises and Bikheris of Manetho should both have to come between those kings.

Most of our knowledge of this king is from the tomb of his son-in-law, Ptah·shepses. He begins his biography by saying that "Menkaura educated him among the royal children, in the great house of the king, in the private apartments ; in the *harem* he was precious to the king more than any child. Shepseskaf educated him among the royal children in the great house of the king, in the private apartments in the *harem* ; he was distinguished with the king more than any boy. The king gave to him his eldest daughter Maāt·kha as his wife. His majesty desired better to

put her with him than with any person. He was precious to the king more than any servant; he entered all the boats, he selected the bodyguard upon the ways of the court to the South in all festivals of appearing. He was secretary of all the works which it pleased his majesty to make, continually pleasing the heart of his lord. He was allowed by his majesty to kiss his knees, and was not allowed to kiss the ground. He pleased the heart of his lord when he entered in the boat 'Which bears the gods,' in all festivals of the appearing, loved by his lord. Satisfying the heart of his lord, loving his lord. Devoted to Ptah, doing the will of his god." He fulfilled many great offices, both priestly and civil; and among these charges we find for the first time priesthoods attached to three obelisks of Ra. These obelisks continued to be worshipped throughout the Vth dynasty: one is named in the phrase "Of Ra · prophet in the Sep-ra," with the obelisk on a mastaba base as a determinative; "of Ra · prophet in the Shepu·ab'ra," with the same determinative; and "of Ra·em·akhti prophet in the Ast·ab'ra," again with the obelisk. On these structures see Sethe (A.Z. xxvii. 111).

SEBEK·KA·RA

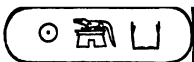
about 3737-3730
B.C.

This king is only known on the table of Sakkara, and his position there is between the end of the kings after the VIth dynasty, and the end of the reversed order of the XIIth dynasty. No such king is known in other lists at that period, and he agrees well to the Manethonic name Seberkheres. But it is perhaps more likely that Sebek·ka·ra is a mistake of the sculptor for Sebek-neferu-ra, who would occupy that place if inserted at the end of the XIIth dynasty. The sculptor made a mistake close by this of *ma* for *dad*.

IMHOTEP



about 3730-3721 B.C.

This king is only known by an inscription of his in the Wady Hammamat (L.D. ii. 115 h): But there is no indication of his position except the apparent equivalence with Thamfthis in Manetho. As there are no other inscriptions as early as this at Hammamat, it is possible that he has been misplaced in Manetho.

In closing the account of this dynasty we will try to grasp somewhat of its character. The essential feeling of all the earliest work is a rivalry with nature. In other times buildings have been placed either before a background of hills, so as to provide a natural setting to them, or crowning some natural height. But the Egyptian consented to no such tame co-operation with natural features. He selected a range of desert hills over a hundred feet high, and then subdued it entirely, making of it a mere pedestal for pyramids, which were more than thrice as high as the native hill on which they stood. There was no shrinking from a comparison with the work of nature; but, on the contrary, an artificial hill was formed which shrunk its natural basis by comparison, until it seemed a mere platform for the work of man.

This same grandeur of idea is seen in the vast masses used in construction. Man did not then regard his work as a piling together of stones, but as the erection of masses that rivalled those of nature. If a cell or chamber was required, each side was formed of one single stone, as at Medum. If a building was set up, it was an artificial hill in which chambers were carved out after it was piled together; thus a mere hollow was left where the chamber should be, and then it was dressed down and sculptured as if it were in the heart of the living rock.

The sculptor's work, and the painter's, show the same

sentiment. They did not make a work of art to please the taste as such ; but they rivalled nature as closely as possible. The form, the expression, the colouring, the glittering transparent eye, the grave smile, all are copied as if to make an artificial man. The painter mixed his half-tints and his delicate shades, and dappled over the animals, or figured the feathers of the birds, in a manner never attempted in the later ages. The embalmer built up the semblance of the man in resins and cloth over his shrunken corpse, to make him as nearly as possible what he was when alive.

In each direction man then set himself to supplement, to imitate, to rival, or to exceed, the works of nature. Art, as the gratification of an artificial taste and standard, was scarcely in existence ; but the simplicity, the vastness, the perfection, and the beauty of the earliest works place them on a different level to all works of art and man's device in later ages. They are unique in their splendid power, which no self-conscious civilisation has ever rivalled, or can hope to rival ; and in their enduring greatness they may last till all the feebler works of man have perished.



CHAPTER IV

THE FIFTH DYNASTY

	MANETHO.	LISTS.	MONUMENTS.	YEARS.	B.C. about
1	Üserkherēs	User'ka'f	User'ka'f	28	3721
2	Sefrēs	Sahu'ra	Sahu'ra	13	3693
3	Neferkherēs	{ Nefer'ar'ka'ra Kakaa. A.	{ Nefer'ar'ka'ra Kakaa ?	20	3680
4	Sisirēs	Shepses'ka'ra	{ Shepses'ka'ra Suhtes ?	7	3660
5	Kherēs	{ Nefer'f'ra. A. Kha'nefer.ra.S.	{ Nefer'f'ra Akauhor ?	20	3653
6	Rhathūrēs	Ra'en'user	{ Ra'en'user An	44	3633
7	Menkherēs	Men'kau'hor	Men'kau'hor	9 8	T.P. 3589
8	Tankherēs	Dad'ka'ra	{ Dad'ka'ra Assa ?	44 28	3580
9	Onnos	Unas	Unas	33 30	3536
					3503
				Total stated 248, actually	218

WITH the fifth dynasty we come to a new family, and to a more marked separation from previous times than

has been met before. In the lists of Manetho the previous dynasties were all Thinite or Memphite, but here we meet a sudden change to Elephantine. In the *Tales of the Magicians of the Westcar papyrus* there is a curiously impossible tale, which evidently embodies some tradition of the change. Hordadef, the son of Khufu, is represented as introducing an ancient magician named Dedi, who tells Khufu that the eldest of three children, yet to be born, shall deliver to him certain documents he desires. Then the birth of the children is described, and the goddesses name them by punning names,—User·ref, Sah·ra, and Kakau, imitating the names of the first three kings of the Vth dynasty. The goddesses also declare of each that it is a king who shall reign over all the land. They then make crowns, and leave them in the house ; and a sound of royal festivity emanates from the royal emblems. A maid-servant out of jealousy starts to tell king Khufu of these new claimants, and the tale is here broken off. The confusion of dates in supposing Kaka to be born in the reign of Khufu is obvious, but yet there is no reason to discredit the basis of the tale. The essential points of importance are that these three kings of the Vth dynasty are supplanters, of whom Dedi prophesies to Khufu, "Thy son shall reign, and thy son's son, and then one of them" ; that these supplanters are born of the wife of a priest of Ra, who conceives these triplets by Ra ; and that the god has promised the mother that they shall reign, and that the eldest of them shall be high priest in Heliopolis. Here, then, the new dynasty starts from a high priest of Heliopolis, and claims divine descent from Ra. Until this tale comes to be considered, it has never been observed that no Egyptian king claims descent from Ra until this Vth dynasty. The earlier kings are always Horus kings, or Horus and Set united ; but no king calls himself "Son of Ra" until the new dynasty, who are here stated to be children of the god Ra, and to begin as his high priests at Heliopolis. Thus the claim of the divine descent recorded in this tale precedes, and accounts for, the new title

found on the monuments. There is a further possibility of connection with this tale; for it is there said that the wife of the priest who bore these kings dwelt at Sakhebu, a place somewhere in the Delta, probably not far from Heliopolis. Possibly here is the origin of Manetho's calling the dynasty Elephantine; according to the tale they come from ; according to Manetho from Elephan-  tine, written  a form which might be a corruption of the real name Sakhebu, by substituting for it the better-known name of Elephantine.

Of the order of the kings of this dynasty there is but little doubt. The only questions are concerning the double names that become common with the new race, who probably each had a second name as a son of Ra, a divine name as well as a human name. The list of Abydos and that of Sakkara each omit one king, but the monuments and Manetho leave no doubt as to the true order.

V. I. USER·KA·F  about 3721-3693 B.C.

Pyramid, *Unb'asut*, Abusir?
Cylinders (M.D. 54 e. B. Mus.).



The position of the pyramid of this king is yet unknown; but as two of this dynasty that have been identified are at Abusir, it seems not unlikely that the others are included among the nine of that group. Unas, however, was buried at Sakkara. Besides the pyramid, there was special devotion in this king's reign to the obelisk standing upon a mastaba-formed base, dedicated to Ra, and known by the name of *Ra'sep*. Both *uab* priests and *neter hon* prophets were attached

FIG. 39.—Cylinder (B. Mus.).

to it. The following are the persons holding sacred offices belonging to the king (K), the pyramid (P), or the Ra-obelisk (R)—

- K Pehenuka (L.D. ii. 48).
 K Ur'ar'na (L.D. ii. 112 a).
 P Affa (M.M. 101).
 P Min'hon (M.M. 199).
 P Ra en kau (M.M. 313).
 R,P Nen'khetf'ka (M.M. 308).
 R,P Ne'ka'ankh (M.M. 311).
 R,K Khnum'hotep (M.M. 312).
 R,K Ptah'hotep (M.M. 314. B.R.I. vii. 3).
 R,K Sennu'ankh (M.M. 316-319).
 R,K Snezem'ab (M.M. 259).
 R,P Dep'em'ankh (M.M. 199).

Of actual remains of this reign there are but two cylinders; one formerly in the Bulak Museum, stolen in 1878, and one in the British Museum. They both belong to the rude class of these cylinders.

V. 2. SAHU'RA  about 3693-3680 B.C.

Pyramid, *Kha'ba*, Abusir, North.
 Sinai, rock stele (L.D. ii. 39 f).
 Sili (?) (G. Mus.).
 Inscription, Sehel (M.I. i. 88).
 Cylinders (B. Mus.; F.P. Coll. See side).



FIG. 40.—Cylinder.
 $\frac{1}{2}$ scale. (F.P. Coll.)

The pyramid of Sahura is determined to be the north one of Abusir, by the red ochre quarry mark on one of the blocks.

In Sinai he warred on the native tribes, and carved a rock tablet commemorating his smiting the Menthu (L.D. ii. 39 f.) A tablet of an official of this reign occurs at Sehel (M.I. i. 88). The worship of Sahura was largely carried on during this dynasty, and lasted

until Ptolemaic times. The priests of Sahura (K) or of his pyramid (P) are as follow—

P	Dep'em'ankh	(M.M. 198).
K	Ankh'em'aka	(M.M. 213).
K	Ka'em'nefert	(M.M. 242).
K	Ptah'kha'bau	(M.M. 294).
P	Nen'khet'ef	(M.M. 308).
P	Sennu'ankh	(M.M. 319).
K	Nefer'art'nef	(M.M. 324).
K	Shepses'kaf'ankh	(L.D. ii. 55).
K	Ai'mery	(").
K	Ptah'bau'nefer	(").
K	Ata	(L.D. ii. 59 a).
K	Unknown,	XIXth dyn. (Serapeum stele 427).
K	" "	(Sarcophagus 38, Berlin).
K	" "	(Memphis, B.R.I. iv. 3).
K	" "	(Serapeum stele 413).

A sill of black granite, apparently from the temple of the pyramid, is in the Ghizeh Museum. Two steatite cylinders are the only small remains of Sahura; one (in Brit. Mus.) gives his *ka* name and cartouche, the other (F.P. Coll.) is figured above.

There are some lists which confirm the order of this dynasty. That in the tomb of Ra-skhem-kha (L.D. ii. 41 a) gives the kings to whom he professes to have been attached; but the range from Khafra to Sahura is so long that it is hard to credit it; the intervening reigns that he mentions are down for 113 years in the lists of Manetho, besides 41 years more of reigns which are presumably interposed, though not mentioned. This might, perhaps, be cut down to 70 years for the named kings by arbitrary retrenchment on Menkaura's reign, but then some years still have to be added for parts of the reigns of Khafra and Sahura, to say nothing of the unmentioned kings between. There is no sufficient proof that a person might not claim to be devoted (*amakh*) to deceased kings (as Ptah'bau'nefer was *amakh* of Khufu) as well as to the living.

The list on a stone in Palermo states the offerings for the feasts of four kings (R.S.D. 74); and the list of

priesthoods of Ptah·kha·bau (M.M. 295) gives also four kings in order. Thus we have—

<i>Ra'skhem'ka.</i>	<i>Palermo.</i>	<i>Westcar papyrus.</i>	<i>Ptah'kha'biu.</i>
Khafra			
Men'kau'ra			
Shepseskaf	Shepseskaf		
Userkaf	Userkaf	User'ref	
Sahura	Sahura	Sah'ra	Sahura
	Nefer'ar'ka'ra	Ka'kau	Neferarkara
			Nefer'ef'ra
			Ra'en'user

V. 3. NEFER·AR·KA·RA

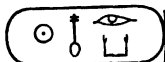

about 3680-
3660 B.C.

Pyramid, *Ba*.

Cylinder, formerly Bulak Mus. (M.D. 54 f).



The pyramid of this king was known as *Ba*, but it has not yet been identified; probably it lies at Abusir.

FIG. 41.—Cylinder. $\frac{1}{2}$ scale.

Thy, whose celebrated tomb is at Sakkara, was keeper of this pyramid (R.S.D. 94). The priests of the king (K) and of the pyramid (P) are—

- P Thy (R.S.D. 94).
 - P Akhut'hetep'her (M.M. 340).
 - P Seden'maät (M.M. 329).
 - P Ptah'en'maät (M.M. 25c).
 - K Snezem'ab (M.M. 258).
 - K Ata (L.D. ii. 59 a).
 - K Urkhuu (L.D. ii. 43).
 - K Ptah'kha'bau (R.S.D. 92).
 - K Shepses.kaf'ankh
 - K Aimery
 - K Ptah'bau'nefer
 - K Ptah'ru'en (Louvre stele, c 154).
- } (L.D. ii. 55).

Offerings to him are mentioned on the Palermo list; and farms are named after him in the tombs of Pehenuka

(L.D. ii. 45), Aimery (L.D. ii. 49), and Semnefer, at Gizeh.

Only one object of his reign is known, a cylinder, formerly in the Bulak Museum, stolen in 1878. (See M.D. 54 f.)

KAKAA.

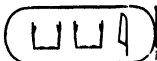

We here come to the most difficult question of the Vth dynasty, the assignment of the double names which several kings then used. Kakaa must be the same as either Nefer·ar·ka·ra or Shepses·ka·ra, as he is placed in the list of Abydos between Sahu·ra and Nefer·f·ra. The Westcar papyrus places him along with the first two kings of the dynasty, and therefore he is more likely to be the same as Nefer·ar·ka·ra; but the matter is not certain. His name occurs in five places, besides a scarab (which may be later than his age by the style), and a fly.

Table of Abydos, after Sahura.

Westcar papyrus, after Sahura.

Quarry works, tomb of Thy (R.S.D. 97).

Papyrus of accounts, Sakkara. (See Assa.)

Name of a queen, Kaka·hekenu, on a vase in tomb of Thy (W.G. 197).

Scarabs (G. Coll. ; B. Mus.).

Fly (B. Mus.).



FIG. 42.—Scarab
(B. Mus.).

Also in place-names in tombs of Ptah·hotep (M.M. 353) and Snezemab (M.M. 504, 509), and a personal name, Kakaa·ankh (R.E. 4, 62).

V. 4. SHEPSES·KA·RA



about
3660—
3653
B.C.

This king is only found on the table of Sakkara, and on a scarab (G. Coll.). This scarcity of remains agrees with his reign being the shortest of the dynasty. Probably he is the same as king Suhtes of the Palermo list of offerings (A.Z. 1885, 78); as that king succeeds Nefer·ar·ka·ra, and the personal names of the next two kings are both known.



FIG. 43.—Scarab
(G. Coll.).

V. 5. NEFER·F·RA

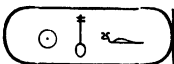
about 3653-3633
B.C.

This king is miscalled Kha'nefer'ra in the list of Sakkara; but the reading of the list of Abydos, given above, is clearly the right one by the monuments.

The pyramid of this king was known as *Neter bau*. Two priests of the pyramid are known, Ra'ankh'em'a (M.M. 283) and Seden'maät (M.M. 329); and two prophets of the king, Ra'en'kau (M.M. 313) and Ptahkha'bau (M.M. 295). He is named on a stele of Sen-amen (G.M. See W.G. 198); and a private person is named after him, Nefer'f'ra'ankh (M.M. 335).

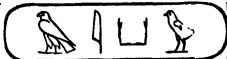
HOR·A·KAU occurring in  is a name only three farm names, in the tombs of Snezem'ab (L.D. ii. 76), Ptah'hotep (M.M. 353), and Semnefer (L.D. ii. 80 b). As all the succeeding kings of this dynasty occur in these farm names of Snezem'ab, there is some presumption that this was the personal name of Nefer'f'ra.

V. 6. RA·EN·USR

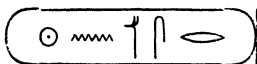
about
3633-
3589
B.C.

AN

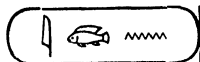

Pyramid, *Men'asut*, Abusir middle (L.A. 7).
Rock tablet, Sinai (L.D. ii. 152 a).
Red granite statuette (G. Mus.).
Statue (by Usertesen I.), Brit. Mus. (L.A. 9).
Alabaster vase, Berlin (L.D. ii. 39 c).
Scarabs.

FIG. 44.—Scarab
(F.P. Coll.).

These two names certainly belong to one king, as they are both given on a statue of king An, made by Usertesen I.; on the belt, and on one side, An is named,

and on the other side, Ra'en·user (L.A. 7). The pyramid of this king is at Abusir, the middle one of the group, as shown by red quarry marks on the stones. The name of it was *Men'asut*, and it is repeatedly found named with priesthoods; these are marked (P), and priesthoods of the king (K), in the list here—

- P Ankh'em'aha (M.M. 213).
- P Ka'em'retu (M.M. 175).
- P Snezem'ab (M.M. 258).
- P Seden'maat (M.M. 329).
- P Ka'em'nefert (M.M. 242).
- P Hapi'dua (M.M. 338).
- P Ptah'kha'bau (R.S.D. 92).
- P Thy (R.S.D. 94).
- P Akhet'hotep (W.G. 199).
- P (?) Nekht'abs, pillar (W.G. 199).
- K Ptah'bau'nefer (L.D. ii. 55).
- K Ata (L.D. ii. 59).

An altar of Ana'ankh (G.M.) belongs also to this reign. A red granite statuette of this king (Fig. 45) was found in the group of early figures at Sakkara, already mentioned (G. Mus.). The alabaster vase bearing the name of Ra'en·user is one of a large class. They are found bearing names of Khufu, Raenuser, Unas, Pepi, and Merenra, and are so much alike that it is hard to believe that they were made during three different dynasties. The original site of them is unknown, but they were probably found all together, as it is unlikely that so many and such thin vases should have survived in the ruins of several temples. They may rather have come from some temple where a king of the sixth or later dynasties had made a set for his predecessors, and several are stated to have come from Abydos. As there are many of Merenra, he is probably their author.

Some scarabs bearing a fish have been attributed to king An, whose name could be thus sufficiently written without the signs *a*, *n*: one scarab with the title *sa ra*, "son of the sun," has a good claim to this attribution, and would be the earliest example of the use of this title claiming descent from Ra.

There has been some uncertainty as to which pyramid belongs to this king, as the name of Ra·user·en has been found at the little pyramid of Riqqah, north of Zawyet el Aryan. As Ra·en·user was a powerful king, with a long reign, it is more likely that the large middle pyramid of Abusir was his rather than that of Riqqah. But in some priesthoods named the pyramid sign is more like an

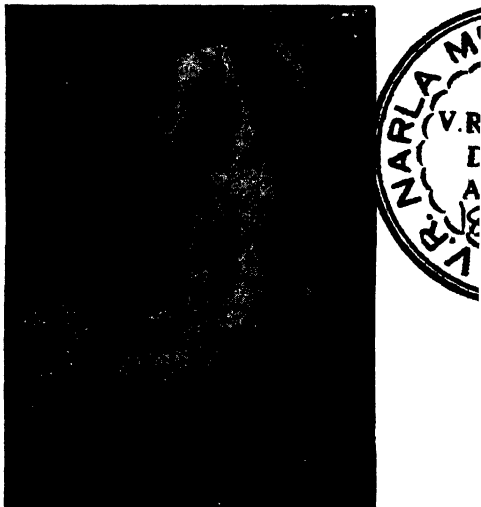
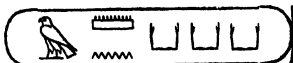

FIG. 45.—Statuette of Ra·en·user (G. Mus.),

obelisk, which has led to the suggestion that the double slope pyramid of Dahshur is represented (W.G. 199); and it may be that the pyramid of Riqqah, which has carving at two angles, may have been a second monument of this king bearing the same name, *Men·asut*.

There is a variation in the spelling of the name of An, a name compounded with his being written as (An·n'y)ankh, and (An·n'a)ankh (M.M. 255; R.E. 4).

V. 7. MEN·KAU·HOR
about 3589-3580 B.C.



Pyramid, *Neter asut* (unknown).
Portrait block (R.S.D. vi. ; L.D. iii. 291, 19).
Rock tablet, Sinai (L.D. ii. 39 e).
Statuette, alabaster, Sakkara (G. Mus.).
Scarabs.

The pyramid of this king has not yet been discovered, but many priesthoods give the name of it as *Neter asut*. The priests and prophets of the king (K) and of the pyramid (P) are as follow—

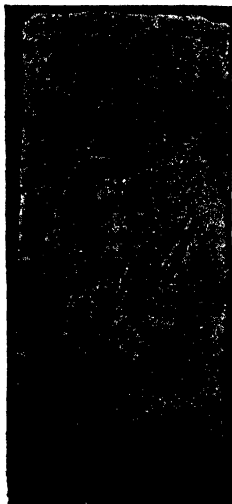

FIG. 46.—Slab with figure of Menkauhor, found re-used in Serapeum (P. Mus.).

P Ptah·hotep (R.S.D. 99).
P Akhet·hotep (R.S.D. 101).
P Ra·ankh·ema (M.M. 280).
P Ptah·nefer·art (M.M. 322).
P Sneferu·nefer (M.M. 395).
P Sem·nefer (M.M. 398).
P Ked·khenes (M.M. 402).
K Ati (M.M. 418).

An interesting slab of this king has survived (Fig. 46), having been built into a wall of the Serapeum. It represents Men·kau·hor standing, holding the baton and staff; over him flies the vulture Nekhebt; in front of him is a vase on a stand and a long bouquet of lotus; and above that is his name, "Good god, lord of the two lands, Men·kau·hor, giving life like Ra." We have already noticed the reasons for this work being as early as the fifth dynasty, in discussing the pyramid of Men·kau·ra. (For the portrait, see R.S.D. vi. ; L.D. iii. 291, 19.)

In late time this king was still honoured, as on a stele

of the period of the empire Thuthu adores Duamutf, Kebhsenuf, and Men·kau·hor (P.R. ii. 28).

The rock tablet at Wady Maghara is small, and partly destroyed; but gives the *ka* name, Men·khau, as well as the cartouche (L.D. ii. 39 e). An alabaster statue of this king was in the group of royal figures found at Sakkara (G. Mus.). Of small objects, there are said to be three scarabs (W.G. 200).

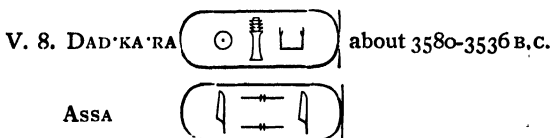

Of these two names the equivalence is fixed by an inscription, "Suten bati (Ra·dad·ka) sa Ra (Assa)" (R.S.D. 100); and by many notices of the pyramid *Nefer*, with each cartouche.

Pyramid, *Nefer* (place unknown).

Rock tablets, Wady Maghara (L.D. ii. 39 d).

„ at mines „ „ (A.Z. vii. 26).

„ (E.G. 536).

„ Hammat (L.D. ii. 115 l).

Papyrus of accounts, Sakkara (G. Mus.).

Alabaster vase (P. Mus.). Flint paint-slab

(F.P. Coll.).

Cylinder (E. Coll.) and scarabs.



FIG. 47.—Scarab
(F.P. Coll.).

The pyramid is frequently named on monuments, both as the *Nefer* pyramid of Dad·ka·ra, and the same of Assa. The prophets of it are—

Ma·nefer (L.D. ii. 65-70).

Snefru·nefer (R.E. ix. 3, 4).

Ra·ka·pu (M.M. 272).

Akhet·hotep (M.M. 421).

Sem·nefer (M.M. 398).

Hesat (R.E. ix. 3).

(Unknown) (L.D. ii. 78 d).

Atush, *uab* (M.M. 296).

The name of Assa is frequently found in farm names, as might be expected from his long reign (L.D. ii. 71, 76; M.M. 351, 383).

There seems to have been a greater activity in the eastern deserts than under previous kings. Three tablets are found in the Wady Maghara, and the long series of inscriptions in the Wady Hammamat begins in this reign. A portion of a stele at Wady Maghara gives the *ka* name and cartouche Dad·ka·ra; with *sa Ra*, the new title which began to come in general use at this period, written after the *ka* name (L.D. ii. 39 d). Another tablet was found in the same place at the mines by Major Macdonald, which mentions the reckoning of cattle, etc. (Birch in A.Z. vii. 26). Ebers found the remains of another rock tablet in very bad condition (E.G. 536); and Brugsch reports two other tablets, which may well be the same copied twice (B.T. 1494, 19, 21). At Hammamat there is an inscription of an official Ptah-hotep, naming Assa (L.D. ii. 115 l).

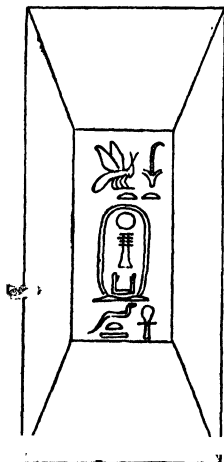

FIG. 48.—Flint ink-slab.
(F. P. Coll.)

Of small objects, some have been attributed to this king, which, from their style, evidently belong to his namesake of the XXVth dynasty, Dad·ka·ra, Shabataka, the Ethiopian. But several are clearly of the early period. An alabaster vase (P. Mus.) is dedicated on "the first festival of the *sed* feast by the king Ra·dad·ka, beloved of the spirits of Heliopolis, giving life, stability, power, expansion of heart for ever and ever." An exquisite polished ink-slab in fawn-coloured chert, bearing

his cartouche, is said to have been found in a pottery jar at Dahshur (F.P. Coll.) (Fig. 48). A

cylinder of black steatite names a prophet of Hathor and of Net, with the *ka* name of the king twice repeated (E. Coll.). Two scarabs are also of this early king, one plain, and one (figured above) with scrolls.

The oldest dated papyrus was found in 1893 at Sak-kara, near the step pyramid, by fellahin digging there. It contains accounts of the reign of Assa; and this, or another found with it, has the name of Kakaa and of the Set·ab·ra obelisk. Unhappily, having been found by natives, it was separated and sold in fragments, which have reached the Ghizeh Museum, Prof. Naville, and M. Bouriant.

This reign is also signalised by the earliest well-dated papyrus composition, the Proverbs of Ptah·hetep. Although the actual copy that we possess (Bibliothèque Nationale, Paris) is probably of the XIIth dynasty, it appears to have been copied from a more cursive original (S.B.A. xiii. 65), which might be of the date of the actual composition; and there seems no reason to question the statement that Ptah·hetep, in the reign of Assa, wrote this work. He seems to have been an aged tutor of the king, who received royal encouragement to place his wisdom and courtesy before the world. The position of Ptah·hetep was of the highest; he was "son of the king, of his body," and therefore probably uncle to king Assa, his pupil. These proverbs are so well known in various translations, literal and metrical, that, as they belong more to literature than to history, we need not quote them here.

V. 9. UNAS



about 3536-3503 B.C.

Pyramid, *Nefer asut*, Sakkara.

Mastabat el Faráun, Sakkara.

Rock tablet, Elephantine (P.S.
xii.).

Alabaster vases (B.M. ; F.M.).

Scarabs.

FIG. 49.—Stele at Elephantine.
Scale $\frac{1}{4}$.

No second name has been found which can be referred to Unas ; and it seems as if he had retained his personal name throughout life, and never adopted a throne name compounded with *ra*.

The pyramid of Unas was found at Sakkara in 1881 (Fig. 50). The entrance is by means of a sloping passage from the north. This reaches a small horizontal chamber, and a passage, which is built of granite shortly before reaching three portcullises, and for some way beyond them. It ends at a square chamber covered with inscriptions. From the west end of this chamber a short passage leads to another chamber, more than half inscribed, containing the basalt sarcophagus. And from the east end another short passage leads to a cross-passage with three small chambers. In a corner of the latter was a heap of small wooden instruments, handles of knives, axes, etc.; these had probably served for the ceremonies of interment, and were left here on the same principle that the long texts of the funeral service were carved on the walls (Rec. iii. 177 ; iv. 41). Beside the pyramid, which was undoubtedly for this king, the Mastabat el Faráun (M.M. 361), at the south end of the pyramid field of Sakkara, has his name in the quarry marks on the backs of the blocks. This

building is a rectangular mass, like the usual mastabas, but larger; it was evidently cased with fine masonry, which has now all disappeared, leaving rough steps. The entrance is from the north, as in the pyramids. A sloping passage turns horizontal at the bottom, passes three slides for portcullises, and lastly opens into a chamber running east and west, with a ridge roof. From the west end opens another chamber with barrel roof. And from the east end of the south side is a short horizontal passage, with four recesses and

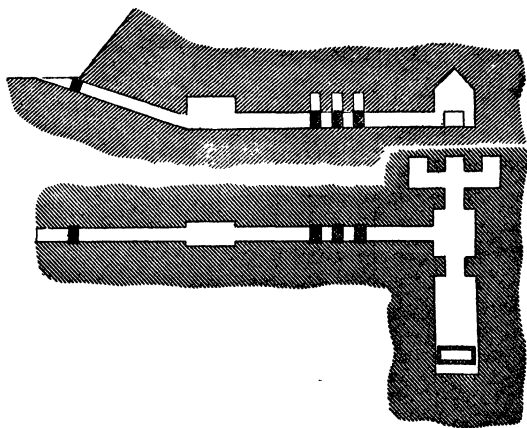

FIG. 50.—Section and plan of passages of the pyramid of Unas.
Scale $\frac{1}{100}$.

a small chamber. The arrangement is closely like that of a pyramid; and every part is equalled in that of Unas at Sakkara, though rather differently arranged. Possibly this structure may have been the tomb of a successor of Unas, who used some old blocks marked with his name. The pyramid of Teta, who followed him, is known; but no tomb of User'ka'ra, the next but one, has yet been found, so that the Mastabat el Farâun may perhaps have been built for him.

On referring to the priests of Unas, there is, however, a curious discrepancy. One of them, Akhet-hotep, has two steles in his tomb; on one stele he is called "prophet of the Unas pyramid *Nefer asut*"; but on the other he is "prophet of the Unas pyramid *Asut asuti*" (?), written with five *as* signs. If this is not a mere error, it may be that Unas had two pyramids (as we have seen to be probably the case with Sneferu and Menkaura); and so the inscribed pyramid and the Mastabat el Farūn may both belong to him. The prophets of the pyramid are—

- Dep'em'ankh (M.M. 195).
- Ra'hent (princess) (M.M. 360).
- Sabu (M.M. 375).
- Ptah'shepses (M.M. 377).
- Akhet-hotep (M.M. 422-424).

It appears that he built a temple to Hathor at Memphis, as Dep'em'ankh was "prophet of the house of Hathor, who loves Unas" (R.S.D. 105; M.M. 195).

The tablet of Elephantine (P.S. xii.) is finely cut on a large rounded mass of granite, in the path to the village, near the ferry place. It is interesting for giving a remarkable spelling of Khnumu with three rams; and it served as a nucleus for four inscriptions of later kings. It is the earliest dated inscription at the Cataracts.

An inscription at Hammamat mentions a man named Unas'ankh; but it is therefore probably later than Unas (L.D. ii. 115 m; G.H. 7).

The Turin papyrus is in good condition at the end of this dynasty, and gives the last three kings and their years of reigning. The numbers do not coincide with those of Manetho: for Men'kau'hor the difference between eight and nine years may easily be owing to omitting the months; for Dad'ka'ra the forty-four years instead of twenty-eight is a difference too large to be accounted for by any co-regency; but for Unas the difference of thirty-three and thirty years may be easily due to three years' co-regency with his predecessor. In the tomb of Snezem'ab his relations to

Assa and Unas suggest that their reigns may have been contemporary (R.S.D. 102). At the end of this dynasty, after Unas, the Turin papyrus gives a summary of kings; but the entry only shows that the reckoning was given from Mena to this point, both the numbers and the years being lost.

Of small remains there are two fine alabaster vases (B.M., from Abydos; and F.M.). The scarabs are commoner than those of any king before this; but there is no variety or interest in them.

The fifth dynasty is marked by its priestly character from the first. Its origin appears to have been a re-assertion of the Heliopolitan element, which may have had a Mesopotamian origin, and which took the form of a usurpation by the priests of Ra in the Delta, who then established the claim to divine descent from Ra, which was maintained by all the later kings of the land. And this priestly tendency is shown by the great attention to religious foundations, there being a dozen or more priests known of each of the earlier kings of the dynasty. The same character is seen in the absence of foreign wars and of great monuments; the kings retained their hold of the Sinaitic peninsula, but the main attention of the age was given to fine tombs and religious foundations.

The productions of the time show much falling off from the splendid style of previous reigns. The masonry is less careful, the forms and colouring are becoming formal; and vivacious as some of the work is,—as in the tomb of Thy,—it is yet miserably flat and coarse when compared with the brilliant and vital representations in the sculptures of the previous dynasty. Declension is evident on all sides, and the work, large and small, is done more for the sake of its effect than for the consciousness of its reality.

CHAPTER V

THE SIXTH DYNASTY

	MANETHO.	LISTS.	MONUMENTS.	YEARS.	B.C. about
1	Othoēs	Teta	Teta	M. T.P. 30 ...	3503
2	...	User'ka'ra	Aty	... 6	3473
3	Fios	{ Mery'ra. A. { Pepy. S.	{ Mery'ra { Pepy (I.)	53 20	3467 3447
4	Methusūfis	{ Mer'en'ra { Mehti'em'sa'f	{ Mer'en'ra { Mehti'em'sa'f	7 4	3443
5	Fiōps	Nefer'ka'ra	{ Nefer'ka'ra { Pepy (II.)	95 9-	3348
6	Menthesūfis	{ Mer'en'ra { Mehti'em'sa'f	{ Mer'en'ra { Mehti'em'sa'f	1 1	3347
7	...	Neter'ka'ra	
8	Nitōkris	{ Men'ka'ra { Net'aqerti	...	12 ...	
					3335
Total stated 203, actually				198	

In this dynasty a new and more vigorous line of kings comes forward. The greater number of monuments, and the wide extent of country over which they are found, show this plainly. There is some uncertainty as to the end of the dynasty, but the greater part is well assured.

VI. I. TETA

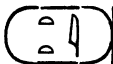

about 3503-3473 B.C.

Pyramid, *Dad'asut*, Sakkara (Rec. v. 1).

Rock graffito, Hat-nub (F.H. iv. xv.).

Alabaster vase, Abydos (G.M.; M.A. 1464).

Alabaster lid (B.M.; P.Sc. 57).

Fig. 51.—Alabaster jar lid. Scale $\frac{1}{2}$.

It appears that Teta never adopted a throne name, but, like Unas, only used his personal name throughout his reign; even in his pyramid no other name is found but Teta. His *ka* name, *se'hetep'tau*i, is only found in a graffito at Hat-nub (F.H. xv.).

The pyramid is arranged in exactly the same manner as that of Unas, excepting that the three small chambers have been thrown into one. But it has suffered far more from the spoilers, who, in search of treasure, have largely destroyed the walls of the chamber at the end of the long passage. Probably this was one of the first pyramids opened by such plunderers; as they have burnt and broken their way through the granite portcullises, instead of cutting a way over them as elsewhere, and they have here smashed the walls, and so gained the experience which showed them that it was useless to search thus in other pyramids. The texts which cover the walls show a decrease in the size of writing, from those of Unas; a change which was carried further in the small hieroglyphs of Pepy. The subjects are more religious, and less of a direct ritual, than those of Unas, though many passages remain identical (Rec. v. 1).

The priests of the pyramid are—

Sabu (M.M. 375).

Ptah'shepses (M.M. 377).

Hapa (R.E. ix. 3).

Asa (P.R. ii. 76).

Mera (tomb at Sakkara).

(Unknown) (L.D. ii. 116c).

while

Ra'hent (M.M. 360) is prophethess of the *Mert* of Teta.

The name of Teta occurs on a part of the coffin of Apa'ankh (Berlin, L.D. ii. 98; see M.G. 98). As apparently a private name, it is written in a square, with a seated man determinative, twice over in the alabaster quarry of the XIIth dynasty at Hat-nub (P.A. xlii.). And it again occurs as a private name at Zauyet el Maiyitin (L.D. ii. 110 0, 1). As it is, however, a common name in early times, these are probably independent of the king's name. Written in a cartouche in a compound name, Teta'ankh, it is among the graffiti of El Kab (L.D. ii. 117; A.Z. xiii. 70). Manetho preserves a tale that this king was killed by his guards, and as a weak reign succeeds him, this is not unlikely.

Of small remains there are very few. An alabaster vase found at Abydos (M.A. 1464) gives the name of "Teta beloved by Dadet," with a figure of Osiris Ba'neb'dadet with the ram's head. This, and the other vase of Unas found at Abydos, suggests that all this class of vases with royal names have come from there. A lid with his name, figured above, is in B. Mus. No scarabs or cylinders are known of him.

VI. 2. USER'KA'RA

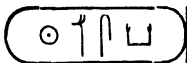

about 3473-
3467 B.C.

ATY

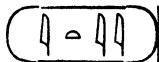

The name of User'ka'ra occurs in the list of Abydos, without any equivalent in the list of Sakkara, and the Turin papyrus is here defective. No other trace of his name has been found. But a king Aty, who apparently reigned for a short time, is recorded in an inscription of his first year at Hammamat, where he sent for stone to build his pyramid. As he appears to belong to this

age, it is conjectured that he is the same as User'ka'ra. There being very few throne names in these dynasties left unfixed to a personal name, this conjecture is not improbable (R.S.D. 149).

The inscription at Hammamat mentions the visit of an official, Ptah'en'kau, with bands of archers and workmen, to bring stone for building the pyramid *Bau* of king Aty. And adjoining this is the name of the noble Aty'ankh (?), the last part of the name having been destroyed (L.D. ii. 115 f; G.H. vii.).

VI. 3. MERY'RA

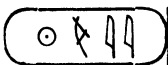

about 3467-3447
B.C.

PEPY (I.)

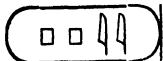

Pyramid, *Men'nefer*, Sakkara (Rec. v. 157).
Jamb of doorway, etc., Tanis (P.T. Pl. i.).
Sphinx (Louvre) ?, Tanis.
Jamb of door, Bubastis (N.B. xxxii.).
Rock stele, Wady Maghara (L.D. ii. 116 a).
Tablet of pottery, Khankah (B.T. 1212).
Rock inscriptions, Hammamat (L.D. ii. 115).
Rock graffiti, Hat-nub (P.A. xlii.).
Piece of inscription, Koptos.
Statuette, Hieraconpolis (Rec. x. 139).
Rock inscriptions, Silsileh (P.S. 539, 630).
Rock inscription, Elephantine (P.S. 309).
" " Sehel (M.I. i. 87).



FIG. 52.—Scarab
(M. Coll.).

Canopic jars from pyramid (G. Mus.; Rec. v. 158).

Statuettes (A.Z. xxiii. 78).

Vases (Rec. v. 158; C.M. ii. 188; P.T.I. xii.).

Plaque (F.P. Coll.).

Cylinders and scarabs.

Queen, *Mery'ra'ankh'nes* (M.A. 523).

Sons, Mer'en'ra Mehti'em'saf.

Nefer'ka'ra Pepy II.

This king has left more monuments, large and small, than any other ruler before the XIIth dynasty; and he appears to have been one of the most active and vigorous of all the early monarchs.

His pyramid was known as Men'nefer, and was opened at Sakkara in 1880. It is of the same type as those of Unas and Teta, except that the eastern chamber is all one, and is not divided into a cross passage and three small chambers. The walls have been greatly destroyed, and the fragments half filled the chambers; many of these pieces covered with inscriptions have been brought to Europe, from the heaps which lay about at the pyramid. An entrance had been forced by mining downward in the middle of the pyramid, and breaking up the deep beams of stone which form the roof of the sepulchral chamber; and this is now a clear section of a pyramid, showing the methods of construction. Not only were there sloping roof beams, of about five or six feet in depth, meeting above in a ridge; but these beams were so long, and went so far into the wall, that their centre of gravity was well within the wall-face, and hence they acted as cantilevers, resting on the wall without any need of touching each other at the top. Not content with one such roof, three roofs of this construction were built thus, one over the other, in contact; in this manner there was an ample surplus of strength. The spiteful destruction of this pyramid is far beyond what would be done by treasure-seekers. Every cartouche in the entrance passage is chopped out; and the black basalt sarcophagus has been elaborately wrecked, rows of grooves have been cut in it, and it has been banged to pieces, breaking through even a foot thickness of tough basalt.

Sunk in the floor is a granite box, in which were placed the alabaster canopic jars and vases (Rec. v. 158). The lid of the box had no fastening, but was merely a slab, a double cubit square.

The inscriptions that remain in this pyramid are of the same type as those of Teta (Rec. v. 157, vii. 145, viii. 87). The body of the masonry, instead of being of hewn stone, is merely built of walls of flakes, filled in with loose chips; showing the feeble work in these later pyramids (Fig. 53).

The prophets of Pepy are numerous. They belong to the pyramid *Men·nefer* (P), to the *Het·ka*, or

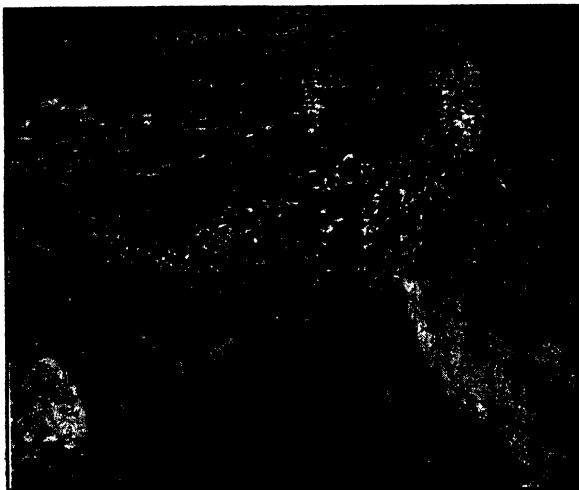

Fig. 53.—Rubble walls and chips forming the mass of the pyramid. At the right is the top of the chamber masonry.

dwelling of the *ka* (K), and to the place called *Mert* (M). In one case a *mer* or keeper is named instead of a prophet, and this is noted here.

	P Mera	Sakkara	Tomb.
	P Adu	Khenoboskion	(L. D. ii. 113 g).
	P Zauta	"	(L. D. fi. 114 g).
	P Una	Abydos	(M. A. No. 529).
	P Shesha	"	(M. A. 532).
	P Mery·ra·'ptah· se·ankh	"	(M. A. 532).
	P Pepy·na	"	(M. A. 528).
M, P	Sesa	Sakkara	(M. M. 420).
P	(unknown)	Silsileh	(P. S. 630).
mer P, M	Assa·kha . . .	Sakkara	(M. M. 456).
K	Ata	Zauyet el Maityin	(L. D. ii. 110 c-g).

K Kaka	Zauyet el Maiyitin (L.D. ii. 110 n).
K (unknown)	" (L.D. ii. 111 k).
? Uha	Posno coll. (W.G. 210).
? (unknown)	Sharona near Minia (Acad. 1885, 135).

And an overseer (*mer*) of the sculptors of the pyramid, named Theta, is recorded at Hammamat (L.D. 115 c).

Of buildings of Pepy there remain a door jamb of red granite with deeply cut hieroglyphs, and a block of granite, at Tanis (P.T. i.); another door jamb at Bubastis (N.B. xxxii.); and a fragment in limestone from Koptos. He is stated to have erected an obelisk at Heliopolis (Pliny), and the foundation of the temple of Denderah is also referred to him in a Ptolemaic inscription there. It seems, therefore, that he was a great builder, as we might gather from the number of quarry inscriptions of his reign. A grand stele was carved by him on the rocks of the Wady Maghara, recording an expedition there in his eighteenth year (L.D. ii. 116 a).

One of the most important monuments of his reign appears to be the great sphinx in red granite from Tanis, now in the Louvre, and companion to a broken one still *in situ*. The original king's name is in a cartouche on the base, at the right side of the sphinx; and, though carefully erased, yet traces of three hieroglyphs remain, as reed *a*, an upright sign (column *an*?) and a drill cap *t*. These show the scale of the signs, and indicate that the whole cartouche held between twenty and thirty signs. Few such long compound cartouches are known except of Pepy I., who often employed such; and the signs would agree well to "*Heru mery tau*, beloved of such and such gods, Pepy, living like the sun." Though the attribution is not proved, it is at least a very probable one; and if accepted, we have here the earliest sphinx known, and a fine portrait of Pepy. Unhappily, no photographs of the Louvre antiquities are available.

At Elephantine he added a line of his name and titles above the stele of Unas (P.S. 309); the cartouche appears to have been altered, and shows traces

of a name, Ra nefer, which cannot be well referred to any king earlier than Pepy, unless to Nefer·f·ra, which is hardly likely. At Sehel occurs an inscription of a man named Pepy ankh (M.I. i. 87). At Silsileh there is a single cartouche, Pepy, not far above the river, on the rocks in the narrow strait (P.S. 539); also an inscription of a prophet of his pyramid, whose name is lost (P.S. 630).

In the quarry of Hat·nub, in the desert behind Tell el Amarna, ten miles from the Nile, are many inscriptions of Pepy. One is dated in the twenty-fifth year, another is at the entrance to the quarry, and a third was carved by a noble named Tehuti·nekht, who was governor of the Oryx nome. Of the same region is Beba, at Shekh Said, who was "*heg hat Pepy.*"

At Hammamat are many inscriptions, carved by the workmen who were sent to quarry stone. The largest (L.D. ii. 115 g) is of special value as naming a Sed festival in his eighteenth year; and this festival recurred at intervals of thirty years, or one week's shift of the heliacal rising of Sirius. It has been supposed that kings held a Sed festival on the completion of thirty years of rule; yet this Sed festival in the eighteenth year points to its being purely astronomical in that age. There is another inscription of the workmen, recording the names of the chiefs of the parties (115 b, c); another of Mery·ra on the throne as king of Upper Egypt, and Pepy on the throne as king of Lower Egypt, back to back, naming the Sed festival (115 a); another with Pepy adoring Min (115, e); another with only the names of the king (115, i); and lastly, a tablet of the chief of the works, Mery·ra·ptah·mery·ankh (115 k).

The graffiti inscriptions at El Kab are entirely of private persons, many of whom are named after Pepy; as Pepy·ankh (L.D. ii. 117 g, h, i, k, l); Mery·ra·senb (117 r); and Mery·ra·ankh (117 p, q, s, u, v). See also A.Z. xiii. 70.

In this reign we meet for the first time with a continuous historical document, which is of great interest as showing what the activities of the Egyptians were in

travel and conquest in this age. The biographical inscription of Una was found in his tomb at Abydos (now in G.M.), and it describes the various labours of his life (R.S.D. vii. viii.; A.Z. xx. 2). He begins by mentioning that first landmark of an Egyptian boy's life, the being girded, or wearing a waist-cloth; equivalent to being "put into trousers" to an English boy. This was under king Teta; and the short reign of User·ka·ra was passed over in his youth. As he grew up, various offices, supervision of the pyramid priests, and a judgeship were conferred upon him, and he came into great favour with Mery·ra. The first honour done to him was the supplying of the fine stonework from the royal quarries of Turrah, near Cairo, for his tomb at Abydos; he specifies the white stone sarcophagus, its cover, the great stele or false door for the shrine, its settings, two foundation blocks, and altar of offering (S.B.A. xi. 316). He took the evidence alone at the trial of the queen Amtes, and wrote the report with one other judge. The royal favour, which gave him facilities of transport for his tomb work, was next extended by setting him over a great raid on the Amu Bedawin to the east of Egypt. Tens of thousands of soldiers were levied from South and North Egypt, and—like the Sudani regiments of the present day—from the negroes of Aarthet, Maza, Aam, Wawat, Kaa, and men of the land of Thamehu. Maspero (R.C. 1892, 364) identifies Aarthet as the region from Derr to Dongola, or Upper Nubia on the west. Aam is between Aarthet and Aswan, or Lower Nubia on the west side; and Wawat opposite to that on the east. The Thamehu are identified with the people of the oases. The whole management of the expedition, and of the officials employed, seems to have been in the hands of Una, and his success in it was the great event of his life. After that, he went on five lesser expeditions, to keep the land in subjection; and he was made governor of the south country, from Aswan northward, by king Meren·ra. He then was employed to bring the special stone for the pyramid of Meren·ra. From

Abhat he brought the sarcophagus of black granite, and a top stone for the pyramid; from Elephantine he brought the granite false door and its sill, and the granite portcullises and their settings, for the interior of the pyramid; also the granite doorway and sills for the exterior temple. And then he was sent to Hat·nub to cut out and bring the great alabaster table of offerings. We now know the exact quarry at which he worked, where the names of Meren·ra still remain, which were probably cut on this occasion. Time ran short before the subsidence of the inundation, and he built a boat during the seventeen days of the month Epiphi, in which he was extracting the stone; he brought it down, but the dry ground was already appearing when he reached Memphis, and he could not safely bring the boat over the inundated ground. This fact shows the season of the month Epiphi in that age, from which—by the shifting of the calendar round the seasons in each Sothis period of 1460 years—it is possible to get an approximate date for the reign of Meren·ra at about 3350 B.C. (P.S. 20). After having thus provided the great stonework for the interior, Una went shortly afterwards to excavate five canals in the south, and build vessels in the land of Wawat to bring down still more granite, for which he was supplied with acacia-wood by the chiefs of the Nubian lands Aarthet, Aam, and Maza, and did the whole work in a year.

This long inscription of fifty lines gives our first clear view of the active, self-satisfied Egyptian officials who did such great and lasting works for their country.

The family relations of Pepy are given in a tablet found at Abydos (M.A. 523). From this we learn that the queen was named Mery·ra·ankh·nes (or Pepy·ankh·nes in another tablet, M.A. 524); and that Meren·ra was the eldest son, and Nefer·ka·ra Pepy II. the second son. Meren·ra died young, and was thus succeeded by his brother. The queen's father and mother were named Khua and Nebt, and her brother Za·u. She also appears as wife of Mery·ra and mother of Nefer·ka·ra in a tablet at Wady Maghara (L.D. ii. 116 a).

Of small remains there is a statuette of black granite found at Hieraconpolis (now in G. Mus., Rec. x. 139); and portions of two statuettes of Mery-ra, one in hard-stone, and one in green glaze (A.Z. xxiii. 78). Some vases of alabaster are in the Louvre, one of them naming the Sed festival (C.M. ii. 188, 6); and a lid in England (P.T. xii. 5). Also a monkey vase in Vienna (W.G. 213). A pottery tablet with Pepy's name and

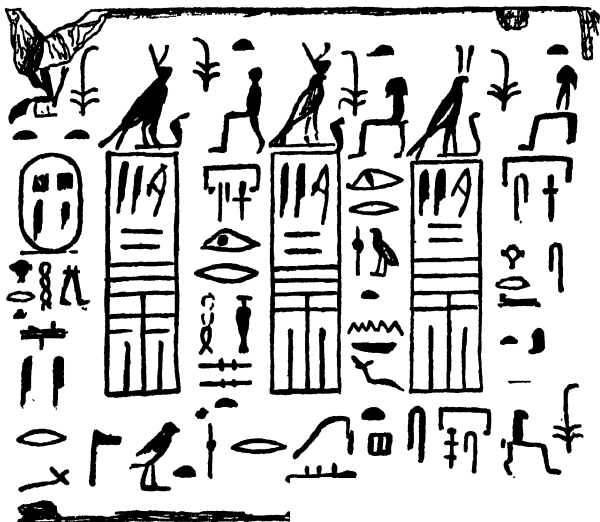
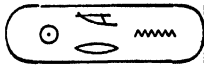

FIG. 54.—Cylinder (Tylor Coll.).

titles was found at Khankah (B.T. 1212); and a green glazed pottery tablet bears the name, "Ra-mery beloved of Min" (F.P. Coll.). Several cylinders of copper and of stone are known (Paris, Posno, B. Mus., Kennard and Tylor Collections); and several scarabs.

The granite altar in Turin with the name of Pepy is certainly of late date (S.B.A. Trans. iii., 110-112).

VI. 4. MER·EN·RA

about
3447-3443
B.C.

MEHTI·EM·SA·F

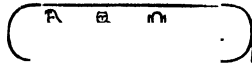
Pyramid, *Kha'nefer*, Sakkara (Rec. ix.
177).Steles, Aswan (P.S. 81, 338; Rec. xv.
147).

Stele, Hammamat (L.D. ii. 115 d).

Vases, alabaster (B. F. and G. Muss.).

Box, ivory, Louvre (C.M. ii. 188, 7).

Scarab (F.P. Coll.).

FIG. 55.—Vase (Flor.
Mus.).

The pyramid of this king was found at Sakkara in 1880. It is constructed like that of his father Meryra. We have already noticed the preparation of the materials in the preceding section, when stating the work of Una. The spoilers have violently ruined the pyramid, and destroyed some of the walls of the chambers; but the black granite sarcophagus is yet in good condition. The inscriptions are mainly the same as those in the other pyramids (A.Z. xix. 1; Rec. ix. 177, x. 1, xi. 1).

The body of Merenra was found in the chamber, despoiled of all its wrappings, but in good preservation; it is now in the Ghizeh Museum. From the body we learn that he died young; even the youthful lock of hair is said to be still on the head (W.G. supp. 22). This agrees with Merenra's short reign of 4 years (T.P.); the 7 years of Manetho is unlikely, as his brother was only six when he succeeded him (Manetho). Considering that the two sons of Meryra were born about 10 years and 2 years before his death, it is very

unlikely that he reigned 53 years as Manetho says; the 20 years of the Turin papyrus is far more likely. We may then, from all considerations of reigns and ages, lay out the family chronology in this approximate order, assuming that the eldest son was usually born when a king was about twenty years of age.

B.C. about

3499	o	Aty born.		
3479	20	son born = o	Meryra born.	
3473	26	succeeded.		
3467	32	died.	12 succeeded.	
3459			20 son born = o	Merenra born.
3449		30 son born		= { o Neferkara born.
3447		32 died	12 succeeded.	
3443			16 died	6 succeeded.
3349				100 died.

As Una records that he was girded under Teta, say at 10 years old, his age during these reigns might be about 12-18 under Aty, 18-38 under Meryra, when he made his great expedition, 38-42 under Merenra, during which time he finished the sculpture of his tomb, having already built it before his expedition. Then after forty-two he probably settled down in private nobility, while others took the lead during the minority of Neferkara, as he does not allude to that at all.

Several prophets of the pyramid of Merenra are known. Una himself held this office, as we learn by a stele from Abydos. The excavation there having been left to natives, we do not know the original places of the steles and inscriptions, and all such records are lost for ever; but the high titles of the stele (M.A. 529) make it practically certain that it belongs to the same person as the long inscription.

Ahy	Sakkara	M.A. F. i. 204).
Una	Abydos	M.A. 529).
Una (another)		M.A. 533).
Una (uncertain)	„	(M.A. 541).
Pepi'na	„	(M.A. 528).
Adu	Khenoboskion	(L.D. ii. 113 g).
Za uta	„	(L.D. ii. 114 g).

A stele on the rock at Aswan records the visit of the king there to receive the submission of the chiefs of Arthet and Wawat in the fifth year (Rec. xv. 147); and another stele (L.D. ii. 116 b; more in P.S. 338) shows an official adoring the king with the two royal names. A third stele is dated in the fourth year (P.S. 81). And at Hammamat is a stele with the royal names (L.D. ii. 115 d).

In the last reign we considered the inscription of Una which relates to his raids on the Amu under Mery·ra, and his bringing of granite for the pyramid of Merenra. We now turn to another invaluable biographical inscription, which relates mainly to this reign, but partly to the next. It is on the front of a tomb in the cliffs of Aswan (S.T. ; R.C. 1892, 358), and records the deeds of a governor of the South named Herkhuf. His father, Ara, seems to have been the immediate successor of Una in the Nubian affairs; as he begins by recording that Merenra sent him with his father on an expedition to Aam (or Lower Nubia, on the west) to explore ("find roads") for seven months; they returned with large quantities of tribute, or plunder. Then Merenra sent Herkhuf a second time alone; he pushed through to Arthet, or Upper Nubia, making an unheard-of circuit of the western countries, during eight months, returning with great tribute. A third time he was sent, starting from Asyut, across the desert, and found the king of Aam (Lower Nubia) on an expedition against the Themhu, "at the west point of heaven," *i.e.* in the western oases: the Egyptians followed the Aam in their raid, and acted so vigorously with them that they thanked all the gods for the king. Having then appeased the chief of Aam, the Egyptians went through Aam to Arthet (or Western Upper Nubia), and returned through Sethu and Wawat on the eastern bank, finding the people all in peace. From these countries they brought 300 asses laden with incense, ebony, leopards' skins, elephants' teeth, etc. For when the tribes saw the soldiers of Aam with the Egyptians, they gave tribute of oxen, goats, and all kinds of pro-

duce. On the return of Herkhuf in triumph, the king sent an official up the river to meet him, with a boat laden with delicacies, as a refreshment after the arduous campaign. In the identification of the lands mentioned, Maspero's view has been followed (R.C. 1892, 358); but Schiaparelli places these countries even farther south. Another curious document is also placed on this tomb, apparently resulting from another expedition in the beginning of the reign of Nefer·ka·ra. It is dated in the second year of that king, and was a royal rescript addressed to Herkhuf in reply to despatches sent from him while he was in the South, probably at Aswan. It begins by saying that Herkhuf having returned as far as Aam in peace, with his soldiers, and brought all good tribute, and this Deng, who is a dancer of god (performing some remarkable religious dance?) from the Land of Spirits, like the Deng that was brought by Ba·ur·dedu from Punt in the time of Assa, and all his work being very excellent;—therefore his majesty orders that when the Deng goes with Herkhuf, attendants shall watch him that he fall not in the water, and shall sleep with him that he run not away; for his majesty (who was then eight years old) loves to see this Deng more than all other tribute. And if Herkhuf keeps him safe and sound, he shall be more honoured than Ba·ur·dedu was by Assa; and all provisions and necessaries are to be furnished for him on the journey to the court (see also A.Z. xxx. 78; A.R. 1894).

We learn from this that even in the time of Assa expeditions had been sent to Punt, and distant products had been brought back. We gather also that the Egyptians established a considerable hold on Upper Nubia, and drafted soldiers from there and received tribute; while from time to time exploratory parties were sent out to examine fresh districts, and to collect by force or favour all that they could.

Of minor remains of Merenra there are some alabaster vases, from Elephantine (M.D. 54 g) and Abydos (M.A. 1465) (both in G.M.), and others in

Florence (C.M. iv. 424, 24) and London. An ivory box with his name is in the Louvre (C.M. ii. 188, 7). And one scarab of his, in blue glazed pottery (Fig. 56), is known (F.P. Coll.).

There is some doubt as to the reading of the second cartouche; the first sign in it has been variously read, Hor, Sokar, or Mehti; and as the Greek version of it is Methusaphis, it seems indicated that we should read it as Mehti'em'sa'f.



FIG. 56
(F.P. Coll.)

VI. 5. NEFER·KA·RA

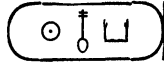

about 3443-
3348 B.C.

PEPV (II.)

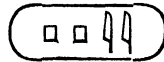

Pyramid, *Men'ankh*, Sakkara (Rec. xii. 53, 136).
Stele, Wady Maghara (L.D. ii. 116 a).
Graffiti, Hat-nub (F.H. iii. iv.).
Sculptures, Koptos.
Stele, Elephantine (P.S. 311).
Base of alabaster figure (W.G. 215).
Granite mortar (G. Mus.).
Limestone jar (G. M.) (B.R. i. 10, 5).
Vase lid, Elephantine (M.D. 54 g).
Vase lid (F.P. Coll.).
Cylinder (M.D. 54 f.). Scarabs.



FIG. 57.—Rosette (G. Coll.).

The pyramid of this king, named *Men'ankh*, was found at Sakkara in 1881. Its construction is the same as that of the previous pyramids; but the inscriptions are in smaller writing, and are longer. The texts are mainly already known in the other pyramids, and are partly religious, partly of ritual. The walls have been considerably destroyed by treasure-seekers. The granite sarcophagus remains in good condition; and the lid has not been overthrown, but

is only pushed aside on to the bench of brickwork which existed in all these pyramids, between the sarcophagus and the wall, to support the lid until the closing of the sarcophagus.

Some prophets of this pyramid are known—

Adu	Khenoboskion	(L.D. ii. 113 g)
Zauta	„	(L.D. ii. 114 g)
Aba	Deir el Gebrawi	(A.R. 1893, 14; Rec. xiii. 67)
Zau	„	(A.R. 1893, 14; Rec. xiii. 66)

At Wady Maghara is a very fine stele, which was carved in his second year; and as he began his reign at the age of six, it was done during his minority. His mother is prominently placed upon it, in name, in her royal connection, and in figure; and from the form of her titles it appears as if she were formally regent at the time (L.D. ii. 116 a).

At Elephantine is a fine stele adjoining that of king Unas (P.S. 311); this mentions the second *Sed* festival of the king, agreeing with his long reign, in which he had three or four such festivals.

In the alabaster quarry of Hat-nub, opened by Khufu, are many inscriptions of this king; three tablets with his names have writing of several lines, one dated in the sixth year; and a deeply-cut group of the royal names is near the entrance. It is these inscriptions which name the place as Hat-nub (F.H. iii. iv.).

At Koptos two slabs of sculpture of this king indicate that he built in the temple (Fig. 58).

Of private tombs mentioning this king there are several. Mery at Kauamat acted under the orders of Neferkara (L.D. ii. 113 f). At Aswan Herkhuf gives the royal letter about the Deng dancer, and as the boy-king was then only eight years old, the subject was likely to captivate his fancy (S.T. 19). Saben was an official connected with the pyramid (Rec. x. 184); and Nekhu, also at Aswan, has the name of the king in his tomb (S.B.A. x. 37). At Sakkara Sauikhu is priest of the pyramid of the king (M.A.F. i. 199). At Girgeh Sesa was represented in his tomb adoring Neferka'ra

(A.Z. xx. 124). And at El Kab a piece of limestone stele names the king (A.Z. xx. 124).

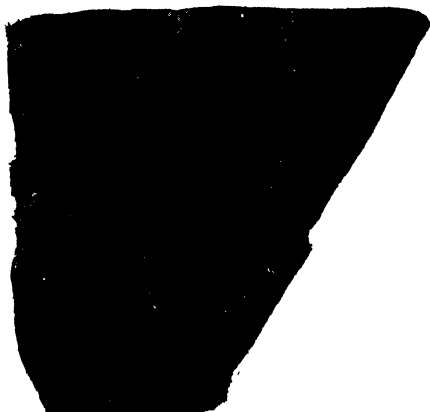

FIG. 58.—Slab from Koptos.

A high lady at the court, Nebt, named also Beba, held offices under this king (M.A. 527); and Khua had a son named Nefer'ka'ra'ankh (M.A. 525).

Of small remains of this king there are a base of a seated figure in alabaster, found at Sakkara (W.G. 215); a large black granite mortar with his name belonged to a king's brother, Amenisenb (G. Mus.); a vase lid from Elephantine (M.D. 54 g); a limestone jar (in G.M.; B.R. i. 10, 5); and many scarabs, which are commoner than those of any other king of the old kingdom (Fig. 59). Several others, however, attributed to Pepy II., certainly belong to Shabaka of the XXVth



FIG. 59.—Types of scarabs of Pepy and following dynasties.

dynasty, and to other kings with the common name Neferkara. In many museums are alabaster vases with the cartouche Nefer'ka'ra; probably one or two may be genuine, though I have not noticed such as yet; but most of them have forged names on genuine vases, the very shapes of which show that they were made in the XIXth dynasty rather than in the VIth dynasty.

VI. 6. MER'EN'RA
MEHTI'EM'SAF } 

about 3348-3347 B.C.

That these two names belong to the same king is certain, as the combined cartouche given above is found in the list of Abydos. In Manetho likewise a Menthe-sufis succeeds the second Pepy. The Turin papyrus has lost the names of this part, but a fragment with the numerals can be identified by the unique reign of Nefer'ka'ra, for over ninety years. The following reign is but one year, and probably refers to this king. No monuments or contemporary remains of him are known.

VI. 7. NETER'KA'RA

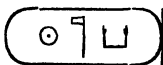

This name occurs next to the above in the Abydos list; but there is no trace of it elsewhere.

VI. 8. MEN'KA'RA

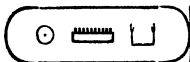

about 3347-
3335 B.C.

NET'AQER'TI

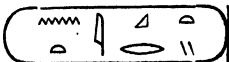

This last reign of the dynasty (according to Manetho) is one of the most questionable. Men'ka'ra succeeds

Neterkara in the list of Abydos, and no other trace of the name is known. On the other hand, the dynasty closes with Nitokris in Manetho, next after Menthesufis. And the reality of this name is confirmed by the Turin papyrus entry of Netaqerti, on a fragment which may reasonably belong to this period.

The only connection between Menkara and Netaqerti is provided by a curious error of late times. The third pyramid of Gizeh is stated by Manetho to have been built by Nitokris; and Herodotos attributes the same to the beautiful Rhodopis (ii. 134), evidently another version of Nitokris, whom Manetho describes as fair and ruddy. But though the third pyramid has been enlarged, it is certain, from the excellent masonry of the core, from the granite casing of the outside, and from the absence of all inscription inside, that it belongs entirely to the fourth dynasty, and has no connection with the rubble pyramids of the sixth dynasty at Sakkara. There is only one possible origin before us for this tale. The real builder of the pyramid being Men·kau·ra, he has been confounded with the queen Men·ka·ra of the end of the sixth dynasty; and these tales thus lead us to associate the name Men·ka·ra with that of Netaqerti or Nitokris, to whom the pyramid is otherwise attributed.

The close of the dynasty appears to have been troublous. According to Herodotos (ii. 100), the brother of Nitokris was slain, and she in turn treacherously avenged him on his murderers. Whether this brother was Mer·en·ra or Neter·ka·ra, there is no evidence. But the former only reigned a single year. It seems that the long reign and great age of Pepy II. had allowed disorder to arise; owing to his feebleness, and probably the number of rival claims in various generations of his descendants, the kingdom had become disorganised; and, after a few brief reigns, the dynasty failed, and a long era of confusion followed. Even the close of the dynasty is uncertain, as we shall see in considering the next era.

Two kings that may be referred to the IVth-VIth dynasties should be stated here, although their exact

place is unknown, as they are only found on isolated objects.

NĒB·KHA RA



FIG. 60.—Scarab
(H. Coll.).

occurs on a scarab of this age (H. Coll.).

HOR·NEFER·HEN



FIG. 61.—Alabaster.
¼ scale (F.P. Coll.).

This name is in a cartouche on a piece of an alabaster lid (F.P. Coll.), apparently of the IVth dynasty. It may well be the same as a name read by Deveria



in Bulak Papyrus, No. 8 (Pap. Bul. i. 39).

This dynasty differs from either of those which preceded it. It has neither the simplicity of the IVth nor the priestly character of the Vth dynasty. The ideal of the time was active foreign conquest and exploration. Monuments sprang up in all parts of the country, and a general development of national life appears which was unknown before.

The art of the time, though becoming more general, is lower in character. The pyramids, instead of being solid masses of stone which rival the hills, are merely heaps of chips and rubble retained by rude walls, and covered with a smooth casing. The tombs of private

persons have not the solidity of those of their ancestors. But the execution of small objects is very fine and sumptuous, as in the ivory box and head-rest in the Louvre. We see in this age the regular effects of the diffusion and cheapening of works which were formerly a rare luxury. Yet there is by no means the depraved showiness which marks the works of the later times of the XVIIIth-XIXth dynasties.

CHAPTER VI

SEVENTH TO TENTH DYNASTIES

THE lack of any prominent landmarks among the names preserved to us in these dynasties makes it needful to treat them together as a whole.

The actual documents concerning them are here arranged, according to what seems to be their most probable relations, the details of which are discussed later on.

TURIN PAPYRUS.	ABYDOS LIST.	MANETHO AND ERATOSTHENES.	MONUMENTS.
9 Neferka 10 Nefer's 11 Ab 12 y Sum dynasty 181 years. Years from Mena 1755.		By sum stated at end of XIth dynasty . . . years from Mena 1756 about 3322 B.C.	
{ 1 (Lost) 2 Nefer'ka'ra 3 Kheti 4 y 5 (Lost) 6 Nefer'ka'ra 7 Khety 8 S 9 (Lost) 10 (Lost) 11 Hor? 12 H	Nefer'ka'ra Nefer'ka'ra Neby Dad'ka'shema'ra Nefer'ka'ra Hor'meren Snefer'ka Ra'en'ka Nefer'ka'ra Tererel Hor'nefer'ka	Thuosimarēs Thirillos	Neby Ra'en'ka

TURIN PAPYRUS.	ABYDOS LIST.	MANETHO AND ERATOSTHENES.	MONUMENTS
13 (Lost)	Nefer'kara		
14 S?.....	Pepy'senb	Semphrukrates	
15 (Lost)	Snefer'ka'Annu		
16 (Lost)	. . . ukau'ra	(VIIth dynasty	
17 (Lost)	Nefer'kau'ra	5 kings, 70 years	
18 (Lost)	Hor'kau'ra	VIIIth dynasty	
Sum dynasty	Nefer'ar'ka'ra	27 kings, 146 years)	
18 kings			
		about 3106 B.C.	
		1 } Akhthoēs, Man.	{ Ab'mery'ra
		2 } Khuthēr, Erat.	{ Khety
		3 Meures, Erat.	Ka'mery'ra
			Maā'ab'ra
		(IXth dynasty	4 Skha'n'ra
		4 kings, 100 years)	5 Kha'user'ra
			6 Aa'hotep'ra
			7 Aa
		about 3006 B.C.	
		(Xth dynasty	Khyan
		19 kings, 185 years)	Uazed
			Yapeqher
		about 2821 B.C.	
.	about 2985 B.C.	
.		Antef I.
.		Mentu'hotep I.
(Lost)	. . .		Antef II.
(Lost)	. . .		Antef III.
(Lost)	. . .		Mentu'hotep II.
(Lost)	. . .		Antef IV.
	. . .	(XIth dynasty	Antef V.
Neb'kher'ra	Neb'kher'ra	16 (?6) kings,	Mentu'hotep III
Sankh'ka'ra	Sankh'ka'ra	43 years)	Sankh'ka'ra
		about 2778 B.C.	

The first entries of the Turin papyrus after Netaqerti have been usually set down to the VIIth dynasty, only because Manetho does not state any ruler after that queen in the previous dynasty. But there are good reasons for supposing that the VIth dynasty really lasted on for four reigns longer. (1) The Turin papyrus makes no break after Netaqerti, but goes on

with four kings more, and then makes a long summary both of the dynasty and of all the kings from Mena. Such a summary is due at the end of the VIth dynasty, but is not to be expected in, or after, the VIIth, which was closely allied to the VIIIth. (2) The total of 181 years is stated at this summary; though only the number remains, yet it cannot be of kings, as not half of that number had reigned since Mena. Now we have seen good reason for taking the Turin numbers rather than those of Manetho; and, adopting them, the dynasty from Teta to Netaqerti occupied 168 years, leaving it thus 13 years short of the Turin total, which would well agree with there being four short reigns more. (3) There is another evidence, which seems at first but very uncertain, yet it agrees so well internally, that it is worth notice. Manetho states the total years from Mena to the end of the XIth dynasty as 2300; and his most probable readings for the length of the VIIth to XIth dynasties are $70 + 146 + 100 + 185 + 43$ years = 544 years. Deducting this from 2300 years, we reach 1756 years for the close of Manetho's VIth dynasty, agreeing to the 1755 years for the same epoch in the Turin papyrus. It is true that this entry is actually 755; but the number is too great to be anything but years, and either 755 or 2755 would be equally impossible for the period since Mena; hence there can be no doubt as to the reading 1755 years, which so remarkably accords with Manetho.

We see, then, good reason to assign these four kings, between Netaqerti and the summation in the Turin papyrus, to the close of the VIth dynasty, thus allowing three or four years each for their reigns.

After a disastrous break, there are two fragments (known as Nos. 47 and 48) of the Turin papyrus. Wilkinson arranged them side by side, and supposed that a number of kings must have double cartouches here, an arrangement quite unknown in all the rest of the document. Brugsch omits No. 48 altogether, as considering that it does not belong to Wilkinson's position. But there seems no reason why frag.

48. may not precede 47, which latter reaches the base of the column; the total length thus entailed is only in accord with the length of other columns of the papyrus, and a fair coincidence is thus obtained with the total number of kings stated at the end of the dynasty, and with the list of Abydos. Accordingly I have here placed a bracket against each of these fragments of this list; and it should be remembered that the first piece is not quite certain in position.

The sum at the end of the dynasty gives eighteen kings, and this number is exactly made up in this arrangement of the fragments. On turning to the list of Abydos, we find only fifteen kings; hence certainly three in the Turin list are not in Abydos. In attempting to adjust the two lists together, then three blanks must be inserted in Abydos, and we cannot expect to find the personal name Khety which occurs at Turin, as the Abydos list is only of throne names. Remembering these points, there is not a single case of contradiction between the lists, and there are some good connections, Nefer'ka'ra, y for Neby, Neferkara, S for Snefer'ka, Hor? (certainly a bird) for Hor'nefer'ka, and S? for Snefer'ka'annu. This last name was miscopied by Duemichen as Ra'nefer'ka, and his error is followed by Brugsch, Wiedemann, Bouriant, and Budge. Three small errors beside this in Duemichen's copy also serve to ear-mark this source of the published copies.

Taking this adjustment as provisional, the question is, what dynasties these kings represent. Manetho gives, according to the most probable text, five kings for the VIIth, and twenty-seven kings for the VIIIth; so these lists could be only a selection out of the thirty-two kings of these dynasties. That these names do not belong to the IXth or Xth is indicated by two points. (1) It is probable that the kings Ab'mery'ra and Ka'mery'ra, found at Asyut, belong to the Herakleopolite IXth and Xth dynasties; but no names of this type occur in these Abydos names. (2) The list of Eratosthenes, though corrupt as to spelling, is

remarkably free from misplacement of names. He gives only a selection of kings; and beginning at his fifteenth, where we reach history, his list and the actual names are as follow—

Saofis	Khufu.
Saofis II.	Khafra.
Moskheres	Men'kau'ra.
Mousthis	Im'hotep?
Pammes	Pepy I.
Apappous (of 100 years)	Pepy II. (100 years).
Ekheskosokaras	?
Nitokris	Netaqerti.
Myrtaios	?
Thuosimares	Dad'ka'shema'ra.
Thirillos (or Thinillos)	Tererel (or Tereru).
Semphrūkrates	Senferka.
Khūthēr (Akhthoes, Man.)	Khety.
Meures	Maā'ab'ra.

Now it seems pretty certain that "Khuthér Taurus, the tyrant" of Ératosthenes, is the "Akhthoes who was more dreadful than all who went before him, who did evil throughout Egypt, and, being seized with madness, was destroyed by a crocodile," as recorded by Manetho. Hence, as this king begins the Herakleopolite dynasties (IXth-Xth), those before him in Ératosthenes belong to the VIIth-VIIIth dynasties; and thus we can assign the period of the list at Abydos, and see that it contains nothing between the VIIIth and XIth dynasties. Further, the next name in Ératosthenes is Meures, probably pronounced Mevres; and this agrees with the king Maā'ab'ra or Maāvra, known on scarabs. From the internal evidence of the reigns, it seems that the XIth dynasty was about contemporary with the Xth; but no kings earlier than Mentuhotep III. were reckoned in the series, and he was adored as a founder in later times.

Having now dealt with the connection of the dynasties, and the nature of the lists, we will turn to consider the few remains that we have of this age.

VII.—VIII. 4.
NEFER·KA·RA
NEBY

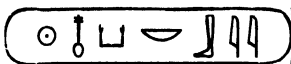

about
3290—
3280
B.C.

Three scarabs are known of this king, one in G. Coll. (Fig. 62), and two others blundered. The style of them is closely like some of Pepy, and they certainly belong to this period.



FIG. 62.—Scarab
(G. Coll.).

VII.—VIII. 6. NEFER·KA·RA

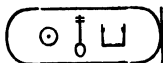

Some of the many scarabs bearing this common name apparently by their style belong to this age. They show the first introduction of the symmetrical designs.



FIG. 63.—Earliest symmetrical scarabs.
(B. Mus.) (F.P. Coll.).

VII.—VIII. 9. RA·EN·KA



about
3230—
3220
B.C.

A few scarabs are known of this king.



Fig. 64.—Scarab
(P. Mus.).

IX.-X. 1. AB·MERY·RA

KHETY

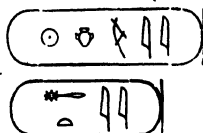
about
3106
B.C.

These two names are known to belong to one king by the fragments of some copper open-work, which may have been parts of a brazier or some round object (Fig. 66). They are now in the Louvre (S.B.A. xiii. 429). There is also a scarab of this king (P.M.), closely like those above

FIG. 65.—Scarab
(P. Mus.).

FIG. 66.—Copper-work, brazier of Khety (P. Mus.).

attributed to Ra'en'ka and Nef'er'ka'ra of the preceding dynasty (see above). And his name occurs

on the rocks at the First Cataract (Acad., 1892, 333). The name Khety is so common as a private name (there being thirty-six in Lieblein's dictionary), that it is of little value for identification; but as this king has left some tangible remains, he may well be the Khety = Akhthoes, the first of the IXth dynasty, who has left the strongest impression behind him, in Manetho. The Khuther of Eratosthenes may easily be a corruption of Khuthes, as final *rho* and final *sigma* are readily confounded in cursive Greek.

IX.-X. 2. KA·MERY·RA

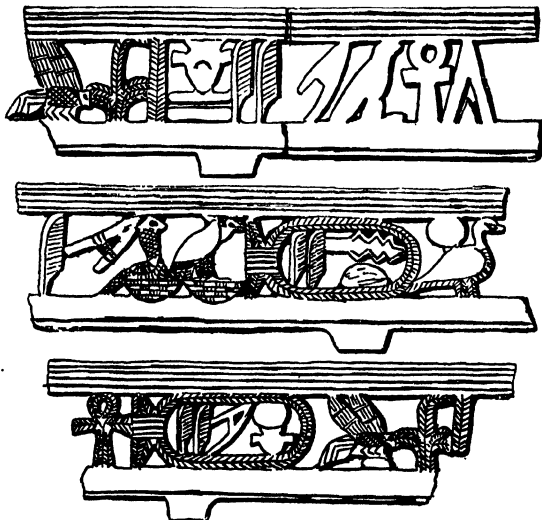
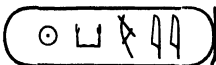

This king is known on a palette in the Louvre (Fig. 67), which was found with the fragments of copper of Ab·mery·ra, probably in a tomb near Asyut. And his name also occurs in a tomb at Asyut (G.S. xiii.). As these tombs throw light on the time, we will briefly notice them. There are three tombs of the princes of Asyut in the IXth and Xth dynasties, Khety I., Tefaba, and Khety II. The first two (according to Maspero, R.C., 1889, 421) were actively engaged in wars against the Theban princes. Khety I. recounts that he cut a canal at Asyut, and so obtained, during the dry season, a full supply of water, by which he irrigated his own nome and enriched the country; he organised the administration, and his justice procured the friendship of the king. Tefaba—probably his son—tranquillised the country, and abolished robbery. The South rebelled from Elephantine to Oau. and he had

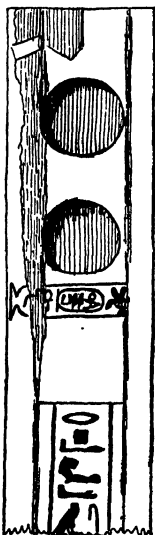
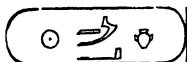

FIG. 67.—Wooden pa-

the Nile. The next prince, Khety II., lived under Ka·mery·ra, and built a temple and prepared a tomb for himself; he also chastised the southerners, the king joining in the campaign; after which the people of the capital, Herakleopolis, came out to meet the king in triumph. We see here how the Thebans were almost independent, constant wars going on between them and the IXth and Xth dynasties. The earlier part of the XIth dynasty is therefore probably contemporary with this Xth dynasty, to which Ka·mery·ra appears to belong; and this agrees with Manetho only stating 43 years for the XIth out of the 160 years or so of those kings, leaving 120 years to overlap the Xth dynasty.

IX.-X. 3. MAĀ·AB·RA



This king appears to be the same as the Meures of Eratosthenes, and therefore belongs to the IXth or Xth dynasty. His scarabs are common, and are all of the same style of work.



FIG. 68.—Scarab
(G. Mus.).

Four other kings of this same period are only known to us by their scarabs, viz.—

IX.-X. 4. S·KHA·N·RA,



whose scarabs are as common as those of Maā·ab·ra.

FIG. 69.—Scarab
(F. P. Coll.).

IX.-X. 5. KHA'USER'RA,

of whom two
scarabs are known
(both G. Coll.).FIG. 70.—Scarab
(G. Coll.).

IX.-X. 6. ĀA'HOTEP'RA,

of whom also two
scarabs are known
(F.P. and Berlin).FIG. 71.—Scarab
(F.P. Coll.).

IX.-X. 7. ĀA,

of whom four
scarabs are known
(G.M. and Evans'
Coll.).FIG. 72.—Scarab
(G. Mus.).

Another king of this age, Nefer'hepu'ra, is reported to be found named at the First Cataract (Acad. 1892, 333).

We have now seen how the Memphite dynasties of the VIIth and VIIIth dynasties fell through decay. The seat of government retreated southward to Herakleopolis, above the Fayum, where it was in constant feud with the neighbouring power of Thebes, which was gradually rising into importance. What was then the cause of this retreat southward? Some catastrophe must have happened to drive them from the ancient seat of power to a comparatively obscure town; and such can hardly be aught else than the intrusion of some foreign power into the Delta. Within the last two or three years we have obtained a glimpse of this power

in the person of one king who became Egyptianised, and who has left monuments behind him which imply that he obtained a suzerainty over all the country, like the Hyksos in later times.

SE'USER'EN'RA  about 3100 B.C.

KHYAN



Statue, Bubastis (N. B. xii.).
 Block, Gebelen (Rec. xvi. 42).
 Lion, Baghdad (B. Mus.).
 Cylinders, scarabs.

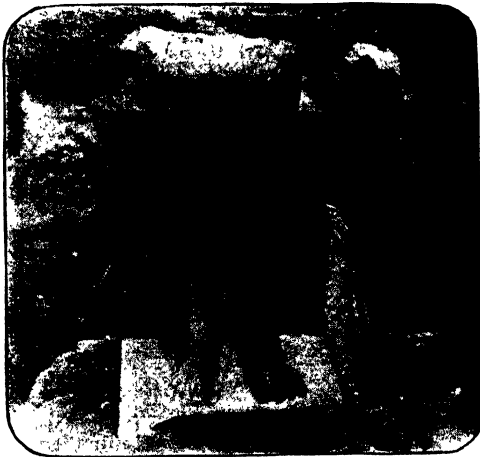
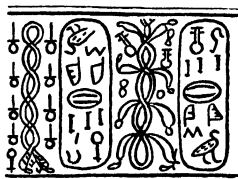

FIG. 73.—Base of statue of Khyan, Bubastis (G. Mus.).

The lower part of the statue of this king in black granite was found in the temple of Bubastis. It is of

Egyptian style, but has unusual titles. Another block of black granite, found at Gebelen, bears the same cartouches; and a lion found at Baghdad, or near there, has an effaced cartouche, which, after much dispute, is now seen clearly to belong to this king. There are also two cylinders and five scarabs which have only risen into importance since the discovery of the statue.

We will now consider the results shown by these remains. In the first place, the scarabs are of two types—(1) with scroll-work down the sides, but not connected across top or bottom, *i.e.* a discontinuous scroll; and (2) usually with a vertical line down each side of the name, and debased hieroglyphs at the edges.



(Athens.)



(Lanzone.)



(M. Coll.)



(F.P. Coll.)



(Spicer Coll.)



(Fraser.)

(Album de
Bulaq.)

FIG. 74.—Cylinders and scarabs of Khyan.

Now, both of these types are common on the scarabs of Pepy, and also in those of Māa'ab'ra of the IXth dynasty. But, on the other hand, not a single scarab of the XIIth, or later dynasties, is known with such designs. It is therefore impossible to assign this king to the Hyksos period, as was supposed at first. Also,

it should be noted that the name is Khyan, and not Rayan, as it has been read. On the statue and the block from Gebelen the *Ra* is always carefully differenced from the *Kh*, either by the added uraeus, or by an unusually large central boss. On the four scarabs and two cylinders, which give the personal name, the *Kh* is always uniformly differenced from *Ra* by two transverse lines. It is therefore impossible to read it otherwise than Khyan. Now, on both the cylinder and scarabs he is named *Heg Sctu*, "prince of the hills" or desert. This same title belongs to the immigrant chief Absha at Beni Hasan. It refers to a rule over the deserts east of Egypt, and Bubastis is the most likely of all the cities for an eastern invader to seize, lying as it does at the mouth of the Wady Tumulat. That Khyan was powerful is evident by his conquering most of Egypt, and apparently ejecting the native kings from their old capital, Memphis. That he ruled over a civilised part of Egypt, appears by the excellent work of his great statue, and the number of his scarabs. He must therefore have been a powerful ruler before he subdued a part of the land. How far his rule extended we cannot be certain; but that a lion of his should be found at Baghdad (B.M.)—too large to be carried in the pocket, too small to have been a trophy of a later conqueror—suggests that he was king, or great shekh, of all the north of Arabia, and ruled from the Euphrates to the Nile.

The Egyptian titles he assumed are peculiar. His *ka* name is *anq adebu*, "embracing territories," a name suggestive of a wide rule. His title after the cartouche is *ka'f mery*, "beloved of his *ka*." To an Egyptian such a title would be absurd, as the *ka* was the man's own double; but to a Semite, whose great belief is in guardian angels and genii attached to individuals or places, the *ka*, or invisible double, would be naturally used as a term for the angelic double. Hence *ka'f mery* would be a likely rendering of "beloved of his guardian angel."

Both of the cylinders are of a rude and ignorant

style. That of Athens has only the plural three lines of *setu*, the three hills of the sign having been confounded with them, and dropped out. The Lanzone cylinder could not be read without other examples to explain it; but, having got the title *heq setu* and *Khy* of the name, we can hardly deny its identity with the other instances of Khyan. It may be that it reads *Khy, aâ* the island sign, *â* the eagle, *n*, *Khyaân*. That the eagle was written thus—much like the goose—is already proved by the scarabs of a seal-bearer, Har.

It is possible that this king has even been entered in the royal list of Tahutmes III. at Karnak. Among the kings on the left side of the chamber, which are all before the XIIIth and later dynasties, there is User'en'ra; and this can hardly be the king of the Vth dynasty, as he already figures in this list as An. Moreover, the position of Userenra is between Mentuhotep III. and an unknown king, and in the same line are kings of the XIth and XIIth dynasties. The position, therefore, would well agree to a contemporary of the beginning of the XIth dynasty; and the only difficulty is in such a foreign prince being included among Egyptian kings. If, however, the so-called Hyksos statues are really of these foreign invaders,—and Amenemhat III. appears to show a resemblance to that type,—it is possible that the foreigners were included in the ancestry of the Egyptian kings.

Two other kings appear to belong to this same period, by the style of their scarabs.



of whom three scarabs are known, the one figured, one with the addition Ra'uazed (F.P. Coll.), and one with discontinuous scroll (G.M.).

FIG. 75.—Scarab (G. Coll.)

YAPEQHER,



of whom two scarabs are known, one with continuous scroll (P.M.).

FIG. 76.—Scarab (M. Coll.).

As these three kings all bear un-Egyptian names, they appear to belong to a series of foreigners; and their remains all point to their being contemporaries of the IXth-Xth dynasties of the Egyptians.

CHAPTER VII

ELEVENTH DYNASTY

FOR this period we have no good list, and need to combine various broken fragments of information. It has been often supposed that the Antef kings and the Mentuhotep kings were of different periods. But there are solid grounds for believing them to be closely interrelated as one family. The tablets of Shut er Regal show us an Antef adoring a Mentuhotep, accompanied by Mentuhotep's vizier (P.S. 443, 489). Then among private names of that age we find Antefs and Mentuhoteps entirely mingled together, as if the names were equally fashionable and usual at the same time. And in the list of Karnak a Mentuhotep comes between two Antefs.

The total number of these kings is also uncertain; so far as monuments go, there is no reason to accept more than nine, including Sankh·ka·ra at the end of the dynasty. The Turin papyrus does not allow of more than six, apparently omitting the first three as being usurping princes, contemporary with other rulers. Such is Maspero's view (R.C. 1889, 421). Manetho states that sixteen kings reigned for forty-three years, and after them Ammenemes for sixteen years. It seems not impossible that Manetho originally wrote six kings, in accord with the Turin papyrus, and that the sixteen has crept in as a corruption copied from the sixteen years of Ammenemes.

From the Karnak list and the monuments the following seems to be more likely than any other arrangement—

	KARNAK.	MONUMENTS,		B.C. about
		Erpa'ha Antefa		3005
1	An(tef I.)	Ra'seshes'her' her'maät	Antefaa (I.)	2985
2	Men(tuhotep I.)	Neb'hotep	Mentuhotep (I.)	2965
3	An(tef II.)		Antefaa (II.)	2945
4	Antef (III.)	Ra'seshes'up' maät	Antefaa (III.)	2940
5	(Mentuhotep II.)?	Neb'tau'ra	Mentuhotep (II.)	2922
6	Antef (IV.)	Hor Uah'ankh	Antef'aa (IV.)	2902
7	Nub'kheper'ra	Nub'kheperu'ra	Antef (V.)	2852
8	Neb'kher'ra	Neb'kher'ra	Mentuhotep (III.)	2832
9	Sankh'ka'ra	Sankh'ka'ra	(Antef VI.)?	2786
				2778

There are some absolute data for this list, and some merely presumptive. The number of the kings is fixed by the list of Karnak in this order; but one name is lost, which is here filled in presumably as a Mentuhotep.

Of the last three kings there is no question, as they are always distinguished by their Ra names. The real crux is to unravel the first four Antefs; and our first clue to them is in the style of their coffins. In the British Museum is a gilded coffin of fine work (Fig. 81); and in the Louvre is a coffin, rather simpler (omitting the ear) but otherwise so closely like the other that they probably came from the same hands (Fig. 79). Now, on the Louvre coffin it is stated that it was made by a king Antef for his brother, and this just accounts for these two Antef coffins being so very closely alike; the British Museum coffin was for the younger brother, who

ordered the gilt coffin in the Louvre to be made through his fraternal piety. In the list we see two Antefs coming next to each other, the IInd and IIIrd, and we can hardly do otherwise, therefore, than attribute the gilt coffin of the Louvre to Antef II., and that of the British Museum to Antef III.

There is also another Antef coffin in the Louvre, that of Ra'seshes'her'her'maât, as he is inscribed on the breast. This is quite different from the others; in place of finely carved features, and richly gilded and worked stucco from head to foot, it is coarsely carved and hideously painted (Fig. 78). In a rising dynasty it would be impossible to attribute such work to a later date than the finely-wrought and gilded coffins; hence it can only be of Antef I.

The next most important monument is that of An'āa or Antef'āa, whose Horus name was Uah'ankh. His tomb stele with his four hounds is well known, and there is also a rock stele at Elephantine. This cannot be Antef III. or V., as their Horus names are different; nor Antef II., as Uah'ankh was succeeded by his son. From the good execution of the carving, it is unlikely to be Antef I., and hence we are limited to placing him as Antef IV., with whose successor—Antef V.—the style of work has an evident connection.

Although there might have been another Antef or another Mentuhotep, we have no monumental warrant for inserting any but those already in the Karnak series. It has been supposed—on the strength of the title being Hor, and not any greater—that the first three Antefs of the Karnak list were not the same as the kings of whom we have actual remains. But it is very improbable that obscure princes would be picked out for insertion on such a monument, to the exclusion of the more important kings of their same family. The Antefs of Karnak must be the greatest rulers who owned that name.

Of the Mentuhoteps there is far less to debate. There are only three distinct ones known; the last of these is fixed by his Ra name; and of the two others,

Neb'tau'i'ra is so much more important than Neb'hotep, that he is almost certainly later.

Prince Antefa  about
3005?—
2985? B. C.

The stele of this prince was found near the Antef pyramids at Thebes, and a portion of it is here copied. It shows him to have been a ruler of the South under

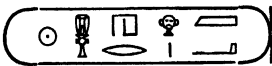

FIG. 77.—Prince Antef (part of stele, G. Mus.).

some king not named. He is entitled "The hereditary noble, ruler of the Thebaid, satisfying the desire of the king, keeper of the gates of the frontier, pillar of the South, the administrator, making to live his two lands, chief of the prophets, devoted to the great god, Antefa." It is important that he is said to "make to live his two lands" (*sankh tau i f*), for, as he speaks of his king,

it is clear that he did not rule over Upper and Lower Egypt, and hence his two lands must refer to the two banks of the Nile; this seems to settle the real meaning of *tau i*. We see then that he ruled the Thebaid and the South, and provided for the country, probably by irrigation (see photo Ms. G. 34, and M.D. 50b). This chief was therefore ruling under the Herakleopolitan kings of the tenth dynasty. The style of his work is rough and formless, but retains somewhat of the largeness of the Old kingdom, and of the character of scenes of that time.

XI. 1. RA'SESHES'
HER'HER'MAĀT



about
2985-
2965
B.C.

ANTEF-ĀA I.

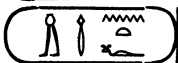

This king is only known from his coffin, which is now in the Louvre (P.R. 185; A.Z. vii. 52) (Fig. 78); it is coarsely carved in wood, and painted with a pattern

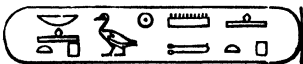

FIG. 78.—Coffin of Antef I. (P. Mus.).

representing wings covering the whole body. The adorning is in blue, red, and dull yellow, and is but rudely applied.

XI. 2. NEB'HOTEP
MENTU'HOTEP I.

about 2965-2945 B.C.



Temple, Gebelen, G. Mus. (Rec. xiv. 26; xvi. 42).

Rock tablet, Konosso (L.D. ii. 150 b).

Stele (private), Louvre, 676 (A.Z. 1869, 52).

The remains of a temple of this king at Gebelen were re-used by Ptolemy VII. The king is shown slaying the Nehesi, Sati, and Tehenu, or the races bordering on Egypt, on the south, east, and west.

A rock tablet at the First Cataract on the island of Konosso is headed by the king's names, but without any figure of him, only portraying three divinities, Khnum, Min, and Sati. The king is promised to have "all lands under his feet." Another tablet at Konosso (L.D. ii. 150c) and one at Hammamat (L.D. ii. 150d) may probably belong to this king, as *se ra* is included in the cartouches, which is not usual under later Mentuhoteps. A private stèle in the Louvre (676) shows an official adoring Mentuhotep, who is seated holding a long *heq* staff.

XI. 3. ANTEF·ĀA (II.)  about 2945-2940 B.C.

This king is only known from his coffin in the Louvre, which was found at Thebes (A.Z. vii. 52;

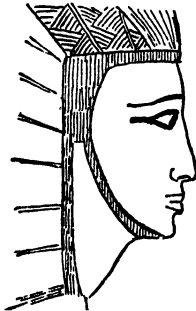

FIG. 79.—Coffin of Antef II. (P. Mus.).

P.R. i. 86). Having been plundered by natives, the site of it is not fixed, but it was almost certainly near

the Antef tombs. He appears to have died suddenly and early, for he was succeeded by his younger brother, another Antef, who made this coffin for him, as he records upon it. The coffin is on the same pattern as the rude coffin of Antef I., but it is well carved and gilt all over.

XI. 4.

RA·SESHES·UP·MAĀT

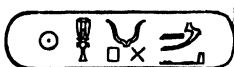

about
2940-2922
B.C.

ANTEF·ĀA III.



Pyramidion (B.M. 578).

Coffin (B.M. 6652; A.Z. 1869, 53).

Funeral box (P. Mus. 614).

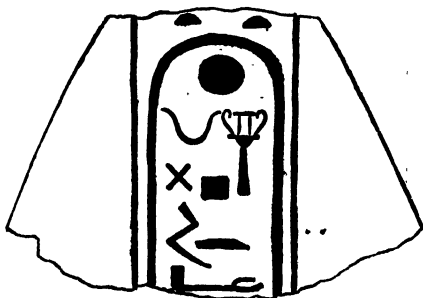

FIG. 80.—Pyramidion of Antef III. (B. Mus.).

The identity of this king with Antef III. rests on a presumption from associated objects. The gilt coffin (Fig. 81) in the British Museum, we have already shewn, belongs to Antef III.; also in the British Museum is a small pyramid of Antef Ra'seshes'up'maāt. Then in the Louvre is his brother's coffin, probably from the same or an adjacent tomb; and also

a funeral box for canopic jars from the tomb of Ra·seshes·up·maāt.

The tomb is mentioned in the Abbott papyrus concerning the inspection of royal tombs. "The monument of king Ra·seshes·em·upu·ma, son of the sun, Antuf·āa. It was found to have been pierced by the

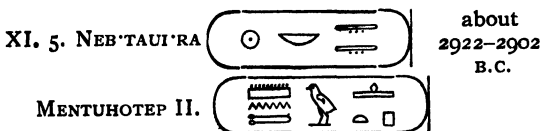

FIG. 81.—Coffin of Antef III. (B. Mus.)

hands of the thieves at the spot where the tablet of the monument is fixed. Examined on that day, it was found entire, the thieves not having been able to penetrate into it." So, as late as the end of the XXth dynasty, some sixteen centuries after the burial, the king yet remained undisturbed.

The style of these coffins sufficiently rebuts Mariette's

abuse of the work of the Antef kings, without further argument. The style is as good as that of Aahmes, and fully comparable with any remains of the Mentuhoteps.



Inscriptions, Hammamat (L.D. ii. 149; G.H.

x.-xiv.).

Inscription, Konosso (B.H. 111).

Scarabs.

Mother, Queen Aam (L.D. ii. 149 f).



FIG. 82. —Scarab
(P. Mus.)

Most of what we know of this king is from the inscriptions cut by the working parties in the quarries of Hammamat. We find that in his second year a *Sed* festival of Sirius' rising took place; another instance which shows that these festivals were then at fixed astronomical dates, and not dependent on the years of the reign. Most of these inscriptions relate to the party who prepared the royal sarcophagus, under the direction of the noble, the vizier Amenemhat, in the second year of the king's reign. They are all dated in the month Paophi, in the second year. The first tablet records a marvel of how a gazelle ran up toward the army, to the rock near where they were, and brought forth her young there, whereat they caught and sacrificed her. This is placed by the side of a tablet of Neb-taui-ra offering to Min, dated on the third day. On the fifteenth day is dated a great tablet set up for the king, who says that he caused Amenemhat to go out with 10,000 soldiers from the nomes of the south, from the south country, from the interior, and from the

Uabu nome, to bring the pure hard stone which is in the rock, to make a sarcophagus as a remembrance for eternity, and for monuments in the temples of the south. On the same day is dated a private tablet of Amenemhat, recounting all his offices and titles, and saying that he was sent with quarrymen and artisans and sculptors, and many other kinds of workmen, and that he brought a great sarcophagus. The soldiers returned without loss, even of one ass. On the twenty-third day an inscription records that they had cut out the sarcophagus, and that they had made a pool of water ten cubits square at a well that they found in the middle of the valley. It was guarded pure from the animals, and carefully hidden from the Troglodytes. And though soldiers and kings of old had passed there, they had never before found this well. Lastly, on the twenty-eighth day, is a postscript added to the royal tablet, stating that they had extracted the lid of the sarcophagus as a block 4 cubits wide, 8 cubits long, and 2 cubits thick; and that then they slaughtered oxen and gazelles, and incense was offered upon the censer. And 3000 sailors from the nomes of the north were following with the expedition. We notice that in one inscription the king is called the son of the royal mother Aam; this not only gives her name, but it suggests that she was queen-regnant during a minority, like the mention of the mother of Pepy II. during his minority.

At Konosso a tablet records the conquests of this king over thirteen tribes (B.H. 111).

Several scarabs are known with the name Neb·taui·ra; and as half of them have the royal titles *neter neser*, or *suten*, they evidently belong to this king. This is the first appearance of scarabs in this dynasty; and they are very small and poor.

XI. 6. HOR UAH'ANKH



about

2902-

2852

B.C.

ANTEF-ĀA IV.

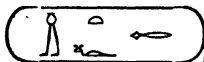

Pyramid, Thebes.

Stele (G. Mus.; M. D. 49).

Rock stele, Elephantine (P.S. 310).

FIG. 83.—Stele,
Elephantine.

The brick pyramid of this king contained a stele (now in G. Mus.) representing the king standing with four dogs. The stele was broken away at the upper part when found by Mariette, and since then it was broken up by the natives, but partly recovered by Maspero. Hence the full name and titles of the king are lost, along with the top, and we do not know the Ra name of this king. The stele was made for the "*Hor Uah'ankh*, the king (An āa) living anew." And, further, before the king is a line naming the usual offerings for the "*Hor Uah'ankh*, the king (Antef-āa)." It has been supposed that these two names must refer to different kings, but the construction does not seem to imply that; and as in no dynasty did two kings take the same *ka* name (or Horus name), it is very unlikely that the name *Uah'ankh* can belong to different persons; rather the An of the first cartouche is an abbreviation of Antef.

The Abbott papyrus mentions this tomb the first of all in the inquest on the condition of the royal tombs under Ramessu X. It records "The monument of king Sa ra An-āa, which is at the north of the temple of Amenhotep of the terrace. This tomb is injured on the

surface opposite the spot where the tablet is placed ; on the tablet is the image of the king, standing, having between his feet his dog named Behukaa. Examined on that day, it was found in good condition."

The subject of the stele is the king standing with four hounds, which bear Libyan names with Egyptian interpretations — "the gazelle," "the greyhound," "the black," and "the fire-pot." A servant, bearing also a Berber name, Tekenru, stands behind the king. Unhappily all the top of the slab is lost, and with it half of the inscription. We glean, however, that Antef had provided libations, built and endowed the temples, and established offerings and services ; he had cut a canal ; he had captured the nome of Abydos and opened its prisons ; he had glorified and benefited his city, and had left the succession to his son ; and in the fiftieth year this tablet was established for the Hor *Uah·ankh*, the king, son of the sun, *Anāa*. A fine rock tablet of his adjoins those of earlier kings at Elephantine (P.S. 310) (see above).

XI. 7. NUB·KHEPERU·RA

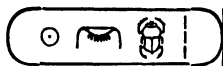

about
2852-
2832
B.C.

ANTEF V.



Tomb and obelisks, Thebes (M. D. 50 a).
Temple, Koptos.
Decree, Koptos.
Statuette (Lee Coll.).
Scarabs.



FIG. 84.—Scarab
(F. P. Coll.).

We find at this point a greater fulness of royal titles appearing ; the *ka* name and vulture and uraeus name being different ; besides the personal and throne names. The two small obelisks, 11½ ft. high, bear all

the names and titles ; they stood in front of the tomb, but are now lying wrecked somewhere in the Nile near Qamuleh, and no attempt has been made to recover them.

The tomb was visited by the Ramesside inspectors, who record "The monument of king Nub-kheper-ra, son of the sun, Antuf, was found to have been pierced by the hands of the thieves, who had made a hole of



FIG. 85.—Slab with head of Antef V., Koptos.

two and a half cubits in its surrounding wall, and a hole of one cubit in the great outer chamber of the sepulchre of the chief of the transport of offering, Auri of Pa-amen, which is in ruins. The royal tomb was in good condition, the thieves not having been able to penetrate into it."

At Koptos, Antef appears to have rebuilt the temple after the disasters of the previous age. About forty

slabs of his work were found turned face down to form the pavement of a later rebuilder. These slabs were mostly small, and all of them thin; they were not blocks thick enough to build a wall, and this shows that the temple was only of brick faced with stone. The subjects were of Antef offering to Min, Horus, and a goddess; and the work was some in relief, some intaglio.

A long decree, dated in the third year of Antef, is inscribed on the side of a great doorway of Usertesen I. at Koptos (now in G. Mus.); by the position it seems to have been recopied there, but the style of the cutting is like that of the Antef IV. stele. In any case, it is doubtless an exact copy of the royal decree, placed here where every person must see it, as being the title-deed of the prince of Koptos. It throws so much light on the administration of the Antefs, and the organisation of the country, that we may well read it here. "The third year, month Phamenoth, 25th day, of his majesty the king (Ra·nubu·kheper, sa'ra', Antef) giving life like the sun for ever. Decree of the king to the chancellor, prince of Koptos Min'em'hat, the king's son administrator of Koptos Qa'nen, the chancellor Menkh·Min, the scribe of the temple Nefer·hotep·ur, all the garrison of Koptos, and all the officials of the temple,—

"Behold ye this decree has been brought to you that ye may know that my majesty has sent the scribe and divine chancellor of Amen Amen'se, and the *semsu hayt* Amen·user, to make inquisition in the temple of Min :—

"Whereas the officials of the temple of my father Min came to my majesty to say that an evil thing is come to pass in this temple, even a harbouring of enemies by (blasted be his name) Teta, son of Minhotep :—

"Therefore let him be cast out upon the ground from the temple of my father Min, let him be driven from his office of the temple, to the son of his son, and the heir of his heir; may they be cast abroad upon the

earth, let his bread and his sacred meat be seized, let his name not be remembered in this temple, as is done to one like him who has transgressed in the matter of an enemy of his god; let his writings in the temple of Min be destroyed, and in the government office on every roll likewise:—

“And every king and every puissant ruler who shall forgive him, may he not receive the white crown, or support the red crown, or sit upon the throne of Horus the living; let not the two diadems grant him favours as beloved of him; and every administrator or prince who shall approach the Lord to forgive him, let his people, his possessions, and his lands be given to the endowment of my father Min of Koptos; also let not any man of his circle, of the relations of his father or of his mother, be raised to this office:—

“Also that this office shall be given to the chancellor, overseer in the palace, Min'em'hat, and let there be given to him its bread and its sacred meat, established unto him in writings in the temple of my father Min of Koptos, to the son of his son and the heir of his heir.”

Here we have the complete formula of a royal commission for one of the greatest acts of administration, the degradation of one of the feudal princes on account of treason, and the establishment of a new ruling family in his place.

Some blocks previously removed from this temple were seen here by Harris long ago built into the bridge, but they have now disappeared.

A statuette shows the king as triumphing over Asiatics and Negroes (Lee Coll.).

The scarabs are rather common in collections, nine being known. All of them are of a symmetrical type, mostly with two uraei, and the name between them. This symmetrical type belongs to the scarabs of the VIIth and VIIIth dynasty, which are probably Memphite in origin. A panther's head in soft blue paste bears the name of this king (B. Mus., glass).

XI. 8. NEB·KHER·RA



about 2832-
2786 B.C.

MENTUHOTEP III.

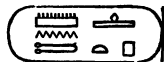

Pyramid, *Akhet-asut*, Thebes (M.A. 605).

Temple, Thebes (S. Cat. F. i. 192).

Tablets, Shut er regal (P.S. 489, 394, 443).

Tablets, Aswan (P.S. 213, 243; L.D. ii. 149 b).

Altar (C.O.E. ii. 78).

Scarab (B. Mus.). Gold heart (P. Mus.).

Menat (XXVI. dyn.). (S.B.A. ix. 181).

Queens—Tumem (M.A.F. i. 134). Aah (P.S. 489).



FIG. 86.—Scarab
(B. Mus.).

This king was the greatest of his dynasty, judging by the number of his monuments; but his unusually long reign may have led to his being thus well represented.

His pyramid is unknown except from a mention of it on a stele at Abydos (M.A. 605) of Tetu, who was chief reciter at the pyramid *Akhet-asut* of Neb·kher·ra, and prophet of *Hor sam tau*, the *ka* name of the same king. But it was officially examined under Ramessu X., and recorded to be then intact. Schiaparelli states that Maspero found at Thebes an architrave with the cartouches of this king, which had been part of his temple (S. Cat. F. i. 192).

The largest existing monument of his is the tablet (Fig. 87) carved on the sandstone rocks of a valley about four miles below Silsileh, known as Shut er regal, or Soba Rigaleh. This shows a colossal figure of Neb·kher·ra standing, with a smaller figure of *sa ra* Antef facing him. This lesser personage is probably a son of his, associated in the kingdom with him, and using a cartouche, but not a Ra name like the father. As the successor of Neb·kher·ra was S·ankh·ka·ra, it is probable that Antef was the personal name of that king, which is as yet unknown. That the king's son is here shown is the more likely, as a queen behind Neb·kher·ra is entitled "The royal mother, his beloved,

Aāh." Behind the king's son Antef is the vizier Khety (P.S. 489). The same Khety is shown on another tablet (P.S. 443) adoring Neb·kher·ra deceased; and he appears on a third tablet, at Aswan (P.S. 213), dated in the forty-first year of Neb·kher·ra. He therefore lived at the end of the reign, and this agrees with his appearing in attendance on the co-regent son Antef. The tablet of the forty-first year records some business with the boats of Wawat, or Lower Nubia. Another tablet of the forty-first year of Neb·kher·ra is carved at

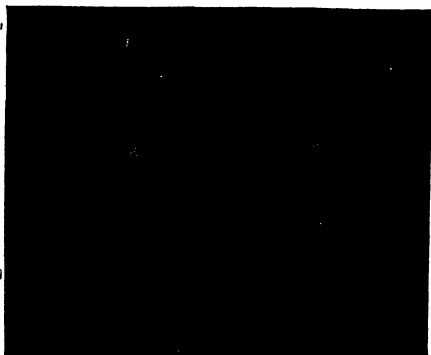

FIG. 87.—Figures at Shut er Regal.

Aswan by an official Mererty (P.S. 243), commissioner in the Heliopolitan nome, and royal friend in the east desert. A short inscription at Aswan gives only the royal names (L.D. ii. 149 b). A block of sculpture (G.M.) shows Neb·kher·ra associated with Uazyt of Buto, and points to this king having worked in the Delta (W.G. 227).

An altar of this reign shows two figures of the Nile offering, and the names and titles of the king repeated: it is described by Chabas from a paper impression by Prisse (C.O.E. ii. 78). Contemporary private works

also record this king. In Turin is a large family tablet of Meru, dated in the forty-sixth year of the king, which is the highest recorded year of his reign. Another tablet of his time (in P.M.) is of Mertisen (L.A. ix.; Pr. M. vii.; S.B.A.T. v. 555), who was a chief artist, and describes his skill. He "knew the mystery of the divine word, an artist skilled in his art. I know what belongs to it, the sinking waters, the weighings done for the reckoning of accounts, how to produce the forms of going forth and returning, so that the limb may go to its place. I know the walking of the image of man, the carriage of a woman, the two arms of Horus, the twelve circles of the injurious (the hours of the nightly passage of the sun), the contemplating the eye without an equal which affrights the wicked" (a play on his name, which is "the two eyes which are equal"), "the poisoning of the arm to bring the hippopotamus low, the going of the runner. I know the making of amulets which enable us to go without the fire giving its flame on us, or without the flood washing us away. No one succeeds in it but I alone, and the eldest son of my body. God has decreed him to excel in it, and I have seen the perfections of his hands in the work of chief artist in every kind of precious stones, of gold and silver, of ivory and ebony." This curious description of the various branches of his art throws some light on the different subjects usually set to students for practice. First, the figures in slow action, then the differences of the male and female figure, then mythological subjects, then figures in rapid action, and, lastly, the trade secrets of the potency of amulets.

A stele of Anmerts names Amen·ra and Neb·kher·ra as the gods (Rec. xiv. 21). Later references to Neb·kher·ra prove how much honoured he was as a restorer of the kingdom. On the statue of Amenemhat (F. Mus.; S. Cat. F. i. 192) there is the usual formula addressed to the royal *ka* of Neb·kher·ra, as to a deity. In tombs of the XVIIIth dynasty at Thebes, Khabekht adores him with the kings of that age (L.D. iii. 2 a),

and Khaui does the same (L.D. iii. 2 d). In the XIXth dynasty the libation table at Marseille bears his name with those of later kings. And in the Ramesseum he is honoured with Mena and Ahmes I. as one of the great kings in the procession of figures.

Of small remains there are remarkably few. Only a gold heart (in the Louvre) and one beautifully-carved scarab (B.M.) can be attributed to his time. Of later work there is, however, a green glazed *menat* with written inscription of this king, probably made in the XXVIth dynasty (S.B.A. ix. 181). His queen is said (M.A.F. i. 134) to be Tumem, who is otherwise said to be an unclassed queen (A.Z. xxi. 77).

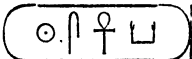
XI. 9. S'ANKH'KA'RA  about 2786-2778 B.C.

ANTEF VI. ?



Inscription, Hammamat (L.D. ii. 150 a).
 Inscriptions, Shut er regal (P.S. 359, 466).
 Statue, Sakkara (W.G. 221).
 Alabaster block, Erment (B.T. 1455).
 Alabaster plaque (G. Mus.). Gold ring with stone
 (G. Mus., see W.G. 221). Scarab (F.P. Coll.).
 Prayer to S'ankh'ka'ra (P.T. II. xlii.).



FIG. 88.—Scarab
 (F.P. Coll.).

The inscription of Hammamat is the only important document of this reign. It records an expedition to the sacred land of Punt, which was the south end of the Red Sea, both on the Somali coast and in Yemen. The regular road to this region was across the desert from Koptos, through the valley of Hammamat to the Red Sea. The general in command was Henu, who had three thousand soldiers with him, drawn from the country south of Thebes, in order to better bear the heat. To cross the desert he provided yokes and skins for the water, and gave a measure of water and twenty biscuits for each man daily. Large reservoirs were dug

at four different points. On reaching the coast, vessels were built to transport the men. The proceeds of the expedition were all kinds of products found in the ports of the Divine Land; and on his return road, through Wady Hammamat, he brought stone for statues of the temples (L.D. ii. 150 a; B.H. 114; Masp. Rev. Hist. ix. 8). This inscription is dated in the eighth year, which shows that this reign was not very short.

In the valley of Shut er Regal the great stele of Neb·kher·ra shows us that he is honoured by an associated son named Antef; and as he was succeeded by Sankhara, according to the Karnak list, and we do not know the personal name of Sankhara, we cannot do better at present than identify him with Antef VI. (P.S. 489). Besides this, at the farther end of the rocks is a tablet showing Sankhara seated on his throne, wearing the crown of Upper Egypt. A dog is seated below the throne. Before the king is a table of offerings, and two attendants with gazelles; behind him kneel, with folded arms, two nobles, the Erpa Tehuti, and another (P.S. 359). Lower down, in the same valley, is the *ka* name of the king (P.S. 466).

A block of alabaster, with the names of this king, from some temple decoration was found at Erment (B.T. 1455).

A statue of Sankhara was found at Sakkara, but seems to have been lost sight of since. Deveria took an impression of it, now in the Louvre (W.G. 221).

A double statuette of a man and wife was found at Khataaneh, near Faqus, with a prayer to Sankhara as a deity (E. Coll.; P.T. ii. xlii.).

Of small objects there is an alabaster plaque from Draa-abul-Nega, naming "King Sankhara beloved of Mentu, lord of the Thebaid" (G. Mus.), a gold ring with a stone (G. Mus.; W.G. 221), and one scarab (F.P. Coll.) of delicate work.

Having now reconstructed the dynasty thus, we may look back and see how far our results are harmonious. We have a steady growth of the royal style: first *Erpa*, then a Ra name where the line of kings succeeds to the

IXth dynasty, then the *sa ra* taken out of the cartouche, and made a regular prefix. We see that no scarabs can be fixed to the earlier kings; they first appear, but poor and small, under Mentuhotep II.; under Antef V. they improve; under Mentuhotep III. the example we have is fine; and under his successor Sankhkara the work is beautifully delicate. In the spread of power we see same growth. Limited first to his nome, prince Antef is a humble servant of the suzerain in Herakleopolis; next, the king Mentuhotep I. asserts his royalty on the southern frontier; next, Antefs II. and III. appear with a fine royal tomb at Thebes, and well-executed gilt mummy-cases; then Mentuhotep II. brings stone from Hammamat, and boasts of conquering thirteen tribes in the south; Antef V. builds at Koptos, puts up obelisks at Thebes, and boasts of conquering both Asiatics and negroes; Mentuhotep III. builds a temple at Thebes, puts up many monuments, encourages art, and is revered to late ages; while, lastly, Sankhkara sends out a foreign expedition, having apparently little to distract him at home. The march of development of this dynasty shows hardly a break; of Antef IV. the deficiency of monuments prevents our noting an advance; but there is no evidence of retrogression. The only points where any change is likely to be made by fresh discoveries is in the number of Antefs before Mentuhotep I., and in the position of the remains we have attributed to Antef IV.

As to the duration of this dynasty, we have but little information. Sankh'ka'ra reigned over 8 years; Neb'kher'ra reigned over 46 years; Nub'kheperu'ra appears to have had a longish reign; Antef IV. reigned over 50 years, and therefore Antef V. might have been his grandson; but that is balanced by the fact of Antef II. being brother of Antef III. On the whole, we seem to count here nine generations; and if we allow not the thirty years of an average European generation, but twenty years each for a succession of Oriental eldest sons, we may set it down as at least 180 years for the whole duration of this list of kings, or 120

years for the six independent kings recognised in the Turin papyrus; but the statement of 43 years in Manetho points to most of this dynasty having been contemporary with the Xth dynasty.

We should now note some remains whose position is uncertain, but which belong to an earlier date than the XIIth dynasty. Of uncertain remains of the Antef period is a false door at Abydos, which mentions the king (sa·ra·Antef·āa) as living then (M.A. 544); a stele of Aui, who names Amenāaa as the great *hen ka* in the house of Antef (W.G. 225); and the song in the palace of Antef by the harper, on the vanity of life, a well-known literary work, of which many copies have come to us more or less mutilated (R.P. iv. 117, vi. 129; Jour. Asiat. vii. xv. 398). A queen Mentuhotep is known to us from her coffin and toilet box (A.Z. xxx. 46, xxxi. 23). The coffin is now destroyed; but a copy of its inscriptions shows that it was for the "great royal wife Mentuhotep, begotten of the vizier, the keeper of the palace, Senb·hena·f, and born of the heiress Sebek-hotep" (S.B.A. xiv. 41). A prince of this line is also known, "Heru·nefer, son of king Mentuhotep and the great royal wife Shert·sat" (S.B.A. xiv. 41). In the Vatican is a head of a statue of rough work with the name of "the good god Mentuhotep."

A scarab has the name An·n·n·t·u·f, a spelling which is unexpected at this period (G. Coll.).

At Khataaneh, a queen's name, Sent, is found; she was heiress, royal wife, and royal mother, and is attributed to this period (N.G. ix.).

CHAPTER VIII

TWELFTH DYNASTY

	MANETHO.	LISTS.	MONUMENTS.	YEARS.		B.C. about	
				M.	T.P.	Mon.	
1	Ammenemēs	S'hetep'ab'ra	Amenemhat I.	16	[1]9	20	2778
			Coregency			10	2758
							2748
2	Sesonkhōsis	Kheper'ka'ra	Usertesen I.	46	45.	32	2716
			Coregency			2	2714
							2684
3	Ammanemēs	Nub'kau'ra	Amenemhat II.	38	...	30	2681
			Coregency			3	2660
4	Sesōstris	Kha'kheper'ra	Usertesen II.	48	[2]9	10	2622
5	Lakharēs	Kha'kau'ra	Usertesen III.	8	3-	26	2578
6	Ammerēs	Maāt'en'ra	Amenemhat III.	8	4-	44	2569
					m.d.		2569
7	Ammenemēs	Maā'kheru'ra	Amenemhat IV.	8	9' 3'27	6	2565
8	Skemiofris	Sebek'neferu'ra	Sebek'neferu'ra	4	3'10'24 ...		2565

Totals stated { 160 213'1'17?
245

THE twelfth dynasty is perhaps the best known chronologically of any before the Greek times; yet here in

some reigns uncertainties beset us. The first four kings are well fixed, by monuments with double datings, which prove exactly when each king took his successor into coregency. Thus only the total lengths of their reigns remains unsettled.

Of Amenemhat I. we have the double date of his 30th year = 10th of Usertesen I. (M.A. 558). Manetho omitted him from the XIIth, and put him as an addendum of 16 years at the end of the XIth. But the far earlier Turin papyrus puts him down as the first of the XIIth dynasty, and makes the summaries count from him.

Usertesen I. had 10 years or more with his father, and 32 years alone, associating Amenemhat II. in the 42nd year; as there is a double date of his 44th = 2nd of Amenemhat II (L.A. x. 3).

Amenemhat II. had two or three years with his father, about 30 years alone, and three or more with his successor; as there is a double date of his 35th year = 3rd year of Usertesen II. (L.A. x. 4).

Usertesen II.'s reign is very unsettled. Manetho gives 48 years for it, but this seems quite unsupported. No higher date has been found than year 10. But we shall see from the totals of the dynasty that there is some reason to assign 29 years to Usertesen II. until the coregency of his successor; and he appears to have lived about ten years more, as (except a war-record of Usertesen III. in his eighth year) there is no dated record of Usertesen III. until the tenth year.

The Turin papyrus shows—9 years; suggesting 29 years for this reign before the coregency.

Of Usertesen III. we may glean somewhat from the lists. His monuments go to the 26th year, the Turin papyrus shows over 30 years, and the 8 of Manetho suggests that it was 38.

Amenemhat III. had apparently no coregency, as monuments are dated in his first and second years. We can hardly do better than accept the highest datum known of his, 44 years. And there is no evidence that the short 9 years of Amenemhat IV. or

the 4 years of Sebekneferu were shared with any other ruler.

We have then the following data :—

	YEARS BEFORE SON'S COREGENCY.	TOTAL YEARS.	B.C. about
Amenemhat I. . . .	20	30	2778
Usertesén I. . . .	42	45	2758
Amenemhat II. . . .	32	35	2716
Usertesén II. . . .	29?	39?	2684
Usertesén III. . . .	38	38	2660
Amenemhat III. . . .	44	44	2627
Amenemhat IV. . . .	9	9	2578
Sebekneferu	4	4	2569
			2565
Totals here	218	244	
Total in T.P.	213,	in Man. 245	

Here we see that the only datum we have partly assumed—the reign of Usertesén II.—serves to bring the total of the dynasty near that of the Turin papyrus, and the total of the reigns to agree with Manetho in Eusebius, as the difference of some few years is easily made up by whole years being counted instead of years and odd months and days. We have, however, adopted the total of the T.P., and thrown the whole difference on Usertesén II. in the dates B.C., as that is the least certain point. The other total given in Manetho by Africanus is a copyist's correction after the corruption of the years of reigns, as 160 is just the total of the figures as they stand in Manetho now.

XII. 1. SE·HOTEP·AB·RA

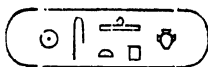

about
2778-
2748
B.C.

AMENEMHAT I.



Pyramid	<i>Ka nefer</i> (site unknown)	(P.R. ii. 108).	
Tanis	Statue	(P.T.I. i. 3; xiii. 1).	
Khataanah	Lintel	(A.Z. xxv. 12; N.G. 9 a).	
Bubastis	Jamb	(N.B. xxxiii. A).	
Memphis	Altar	(M.D. 34 f).	
Krokodilopolis	Statue	(L.D. ii. 118 e, f).	
Abydos	Altar	(M.A. 1338).	
Hammamat	Inscriptions	(G.H. ii. 4, iii. 3, viii.).	
Koptos	Sculpture		
Karnak	Altar and statue	(M.K. 8 d, e).	
Elephantine	Inscription	(P.S. 308).	
Aswan	Inscriptions	(P.S. 67, 179).	
Korosko	Inscription	(A.Z. xxii. 30).	
(In Berlin)	Altar	(L.D. ii. 118 i).	
Cylinders and Scarabs.			
Papyri	Instructions of Amen- emhat I.	(S.S.A.).	FIG. 89.—Scarab (E. Coll.).
	Sa'nehath's Adventures	(Ms. C. 95; S.B.A. xiv. 452).	

Although the latter part of the XIth dynasty seems to emerge from the confusion into a tolerably stable and important condition, yet it was the glory of the twelfth dynasty to promote far more organisation and justice than had been reached before. We see this reflected in the *ka* names of the kings, which form a sort of summary in mottoes of the aim of each monarch. Antef III. is "opening or beginning justice"; Mentuhotep II. is "lord of the two lands," a matter merely of possession and might; Mentuhotep III. is "uniting the two lands"; Sankhkara is "making his two lands to live"; and Amenemhat I., having entered into full possession of the country, needs not refer to its division, but takes the motto "renewing births" as reinstating the living organisation of everything

in the country; while Usertesen I. carries on the idea in the phrase "life of the births," or the national life as renewed and born again. Thus in this series we see expressed the royal motto of each king, that name which he took for his *ka* on his accession, apparently as his claim to the favour of the gods, when his *ka* should appear before them, and join Ra after his death. These mottoes generally refer to the care of the king for his royal duties to the country over which he ruled; and in this case of an emerging civilisation, the sentences give a beautiful sketch of the progress of the country under a line of strong rulers, granting justice, subduing the land, uniting it, making it live, renewing its birth of social life, and cultivating the renewed life thus regained.

The document which gives most direct light on the state of the country is the biography of the grandfather of Khnum-hotep at Beni Hasan. The king Amenemhat I. placed the grandfather (who appears to have been a previous Khnum-hotep) "as hereditary prince, administrator of the eastern desert in the town of Menat-khufu; establishing for him the south landmark, and making firm the northern one like heaven, and dividing for him the great river down its middle, setting its eastern half to the nome of the 'Rock of Horus,' reaching to the east desert. Whereas his majesty came that he might abolish wrong, gloriously appearing even as the god Tum himself; that he might set right that which he found ruined, and that which one city had taken from its sister city; that he might cause one city to know its boundary with another city; establishing their landmarks as heaven; reckoning their waters according to that which was in the writings, apportioning according to that which was in antiquity, of the greatness of his love of right. He arose and placed him (Khnum-hotep) as hereditary prince, favoured by the royal hand, great chief of the Oryx nome. He set up the landmarks; the southern one as his boundary to the Hare nome, his northern one to the Jackal nome; he divided the great river

valley down its middle, its water, its fields, its wood, its sand, as far as the western desert." We see here the personal care of a vigorous administrator in renewing the birth of all the social organisation of the country (G. Bh. 58).

In every part of Egypt we find alike this remarkable vigour of the new administration. Amenemhat must have been one of the most active and capable monarchs in the whole history of Egypt. From the edge of the Delta at Tanis to the wilds of Upper Nubia at Korosko we alike find the remains of his works. Instead of one or two monuments, as of the previous kings, we see a number which shows that he built and offered in most of the great towns of the country.

Beginning at the north, it appears that he must have decorated the temple of Tanis, an excellent statue of his, still remaining there (Fig. 90), brutally usurped in after times by Merenptah (P.T. I. i. 3; xiii. 1). And from the quality of the red granite resembling that of the granite columns there, and from the brilliant finish of these columns, we can hardly doubt that they are a part of a rich temple built there by this king.



FIG. 90.—Head of Amenemhat I, red granite, Tanis. 9 a).

At Khataanah, near Tanis, is a fine lintel of a doorway erected by Amenemhat I. in red granite; and the later additions there by his successors point to a noble building having stood there (A.Z. xxv. 12; N.G.

At Bubastis a block of this king records his making monuments to his mother Bast (N.B. xxxiii. A).

At Memphis, in the Kom el Qalah, was a red granite altar dedicated by the king to Ptah (M.D. 34 f.).

At Krokodilopolis is the lower part of a red granite seated group of Amenemhat and Bast, side by side (L.D. ii. 118 e, f. ; but see P.H. 57).

At Abydos was found a red granite altar, dedicated by the king to Osiris (M.A. 1338).

In the Wady Hammamat is a long inscription of an official, a priest of Min, named Antef, who was sent to Rehenu to bring noble hard stone. For eight days he sought for it in the mountain, and could find none suitable. In despair, he threw himself on his face and prayed to Min, Mut, Urt'hekau, and all the gods of the desert, and offered incense. The next day he searched in four rocks more, and at last found the stone. This touching record of his troubles is irregularly squeezed in at the bottom of the fine, pompous inscription, which he evidently set his masons to cut when beginning this weary eight days' search, and before he anticipated his difficulties (L.D. ii. 118 d; G.H. viii.). Two other inscriptions of the same reign record the work of one Ada in bringing stones for Zautaker, a divine father and priest of Min ; probably for decorating the temple of Min of Koptos. He brought two stones of 10 cubits long (G.H. ii. 4), and one of 12 cubits, for which he had a party of two hundred men, two oxen, and fifty asses (G.H. iii. 3).

At Koptos, a beautifully-sculptured slab in relief (Fig. 91) shows that this king rebuilt or decorated the temple there.

At Karnak is a group of two figures with the names of Amenemhat (M.K. 8 d), and, as at so many other places, an altar of granite with his dedication, in this case to Amen'ra (M.K. 8 e). These show us the beginning of the decoration of the temple, founded by Mentuhotep, which afterwards became so great by successive additions.

At Elephantine, Amenemhat added his tablet on the rock of kings, which already bore the names of four monarchs (P.S. 308). And a little farther we find, just

above the cataract, a high pile of rock by the river bearing his name on the very top of it, and referring apparently to the obtaining of stone for his pyramid (P.S. 67); while another rude inscription by the cataract is dated in his reign (P.S. 179).

Nubia also was subject to this king. In the "Instructions of Amenemhat to his son," he declares that he had fought the Wawat (Nubians), the Mezau (S. Nubians),

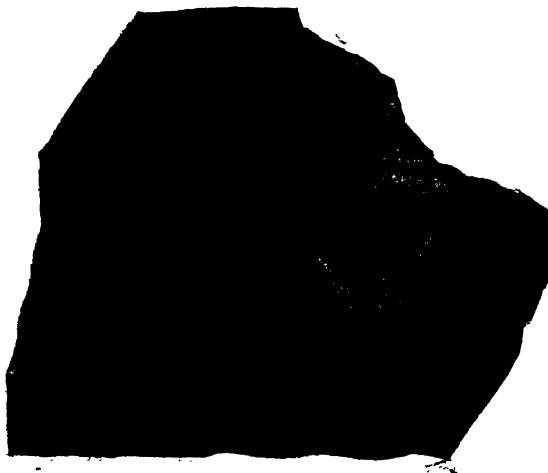

FIG. 91.—Slab of Amenemhat I. Koptos.

and the Sati (Asiatics). That this Nubian conquest was more than a boast is proved by the pithy record on a rock at Korosko: "In the 29th year of S'hotep'ab'ra, ever living, they came to overthrow the Wawat." This campaign was doubtless carried on by Usertesen I., like the campaign against the Libyans in the following year, during which the old king died in Memphis.

Of his pyramid, called *Ka nejer*, we do not yet know the place; and the name of it is only recorded on a

stele of Hor, who was a priest of the pyramid in the ninth year of Usertesen I. This, dating by the young king a year before the old king's death, shows how completely the reins had fallen from the hands of that great man, whose abilities had again raised Egypt to the front rank of the world. He died early in his thirtieth year of reign, on the 7th of Paophi. (See Sanehat.)

Several private monuments are dated in this reign; but when such do not refer to historical events, we shall not notice them in this account, except where the name of a king is so rare that the smallest detail is of value.

Several scarabs and a cylinder of Amenemhat are known. Some rude scarabs, inscribed *Ra's-hotep'ab*, may, however, rather belong to the kings of that name in the XIIIth dynasty. Some of the work of the scarabs is most exquisite in detail.

We shall now turn to a vivid picture of the life and connections of Egypt at this age, in the *Adventures of Sa'nehath*, or the "Son of the Sycamore." As the tale will soon be printed in full, we will only epitomise it to point out its interest. The story is in the form of an autobiography, and Sanehat begins by stating his titles, which were of high rank,—hereditary prince, royal seal-bearer, confidential friend, judge, keeper of the gate of the foreigners, true and beloved royal acquaintance, follower of the king, of the household of the queen. He was in the army commanded by the coregent Usertesen I. on an expedition against the Temehu, or Libyans. As they were returning, laden with spoil, messengers came to the coregent to inform him secretly that his father had died. Sanehat was standing by, and overheard the news. At once he was seized with panic fear, and fled away to Syria. The cause of his terror has always been a question to translators; but we may guess, from the familiar manner in which he is received by the royal family on his return in his old age,—with a stipulation that none of his children should come with him,—that he may have been a

son of Amenemhat I. During his father's life he would be safe, but so soon as the old king died, he dreaded being cut off by the heir, who might see in him a possible rival. Thus the difficulties and unexplained points of the tale receive a consistent solution: the many high offices held by one who was quite young; the frantic terror of his flight, the familiar reception on his return, and the leaving of all his family and goods behind him on re-entering Egypt.

After fleeing from the army, when he heard of the king's death on the road from the Natron lakes, he went south, slept one night in the open field, got to about Gizeh the next afternoon, ferried himself over the river on a raft, passed Gebel Ahmar, and came to a frontier wall. After a rest there, he went on by night to escape the guards, and reached the Wady Tumilat next day, where he almost perished from thirst. Some Bedawin found him and rescued him, and he passed on from tribe to tribe till he reached Edom. There, after a time, he found favour with the prince of the hill country of Judea, who was probably in the region of Hebron, judging by the allusions to a goodly land, with figs and grapes, honey, olives, and fruits, barley and wheat without end, and much cattle. There he married the eldest daughter of the prince, and his children each became shekh of a tribe. He generalled the fighting men of his father-in-law, and had a grand single combat with a champion of a neighbouring tribe, in the manner of Goliah. In his old age he longed to see again his native land, and sent a petition to Usertesene, in which he recites his present condition, and asks, "Let this flight obtain thy forgiveness, that I may be appointed in the palace, that I may see the place where my heart dwells. How great a thing is it that my body may be embalmed in the land where I was born! To return there is happiness." The king replied to him, with presents, and the royal family sent him greetings. The royal message was gracious, accepting his assurances, informing him that the queen and family were well, and telling him, "Leave all the riches that thou

hast, and that are with thee, altogether. When thou shalt come into Egypt, behold the palace; and when thou shalt enter the palace, bow thy face to the ground before the Great House; thou shalt be chief among the companions. And day by day behold thou growest old; thy vigour is lost; and thou thinkest on the day of burial. Thou shalt see thyself come to the blessed state; they shall give thee the bandages from the hand of Tait, the night of applying the oil of embalming. They shall follow thy funeral, and visit the tomb on the day of burial, which shall be in a gilded case, the head painted with blue, a canopy of cypress wood above thee, and oxen shall draw thee, the singers going before thee, and they shall dance the funeral dance. The weepers crouching at the door of thy tomb shall cry aloud the prayers for offerings; they shall slay victims for thee at the door of thy pit; and thy pyramid shall be carved in white stone, in the company of the royal children. Thus thou shalt not die in a strange land, nor be buried by the Amu; thou shalt not be laid in a sheepskin when thou art buried; all people shall beat the earth and lament on thy body when thou goest to the tomb."

Sanehat was delighted at this reply, and sent a long letter of adoration to the king, in which he says, "I who speak to thee shall leave my goods to the generations to follow in this land." He then made a feast, and bade farewell to all, giving his goods and estates to his eldest son. And, setting forth, he was received by the frontier officers, and passed on to the palace, meeting royal provision sent for him by the way. From this he gave presents to his followers who had come so far with him, and sent them back, committing himself entirely to the four messengers sent to conduct him. The king received him graciously, and then called in the queen and family, who could not recognise him at first. When assured of the wanderer's return, the royal daughters performed a dance and chorus of praise to the king. Then Sanehat was accompanied out of the palace, hand in hand with the royal children,

and given an establishment. He cast away his foreign dress, and had his long hair shaved off; he dressed in fine linen, anointed himself with the finest oil, and slept on a bedstead, no longer lying on the sand. A grand tomb was built for him by the king, and he ends by a wish that he may continue in the king's favour. From the absence of any account of his burial, it seems that this was a real autobiography, composed by the old man before he died. It gives a very curious view of the relation of Egypt to Syria at the beginning of the twelfth dynasty. A fugitive Egyptian was superior to the Syrians, and by his education and ability might rise to high power, much like some English adventurer in Central Africa at the present time.

XII. 2. KHEPER·KA·RA

about 2758-
2714 B.C.

USERTESEN I.



Wady Maghara
Sarbut el Khadem
Tanis

Stele
Stele
Statues

Brugsch, Hist. 139.

(P.T. i. 4, ii. 5, 8, xiii.
2, 3, 4) (and Berlin).

Faqus
Heliopolis
Begig
Hat-nub

Sphinx
Obelisk
Obelisk
Graffito
Statue

(A.Z. xxiii. 11).
(L.D. ii. 118 h).
(L.D. ii. 119).
(F.H. x.).
(M.A. 345).
(My. E. 326).



FIG. 92.—

Abydos
Hamamat
Koptos
Karnak

Inscription
Sculptures
Inscription

(M.K. 8 a-c).
(A.Z. xx. 123). (F.P. Coll.)
(My. E. 508).

Taud
Hjeracopolis
Aswan

Altar
Columns
Inscriptions

(L.D. ii. 118 a-c;
P.S. 91, 113, 271, 273).

Wady Halfa
Wady Halfa
(Florence)
Wady Halfa

Brick temple
Stele
Stele

(S. Cat. F. 1542).

(Ashmolean Museum).

Statue	(B. Mus.).
Statuette, carnelian	(Formerly in Louvre).
Glazed vase from Abydos	(M.A. 1466).
Marble vase	(Piece in B. Mus.).
Shells	(B. Mus., etc.).
Weight of Hor'mera	(Vienna Rec. xii. 10).
Scarabs and Cylinders.	

As we have seen, under the last reign, Usertesén was associated for ten years with his father; and during at least the latter part of that time he carried on the external affairs of the kingdom, by expeditions both to the south and the west. So feeble does the old king appear to have become, that the internal administration also devolved upon the son very soon after his accession.

A leather roll, written under Amenhotep IV., professes to give a copy of the account concerning the building of the temple of Heliopolis in the third year of Usertesén, that is, seven years before his father's death; and he is stated to have been crowned with the double crown, and surrounded by his courtiers. Little, however, can be learned from this composition, which is poetical in arrangement, and appears to be entirely a piece of "fine writing." But as the ceremonial reciter (*Kher'heb*) is stated to have stretched the cord and laid the foundation in the ground, it must speak of an original building, and not of a mere restoration (A.Z. xii. 85, R.P. xii. 53). Of the work of this temple nothing now remains but the one celebrated obelisk of Heliopolis (L.D. ii. 118h), which records that it was made in the beginning of the *Seâ* festival of thirty years. The fellow obelisk to this was not overthrown till 1258 A.D. according to Makrizi; and in 1200 A.D. the obelisks still retained their ancient caps of copper, according to Abd el Latif (cap. iv.).

From a tablet of the first year at Aswan (P.S. 271), and this above record of the third year, there is a series of dated inscriptions, mostly private, which extend throughout the reign to the forty-fourth year. This custom of dating monuments is but little known before

the XIIth dynasty, and is not so usual after this period ; but a special fashion of precise dating seems to have prevailed during this age. As there is apparently little to be learned from these private monuments that are dated, we shall continue to notice the remains in geographical order, as that yields a view of the regions of activity in the various reigns.

In the Sinaitic peninsula Usertesén again asserted the Egyptian power, and at Wady Maghara (Br. Hist. 139) and Sarbut el Khadem are memorials of his time.

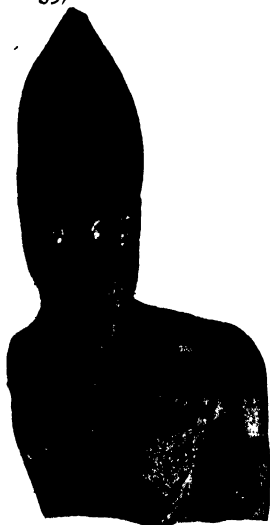

FIG. 93.—Bust of Usertesén I., black granite, Tanis.

At Tanis he placed at least three statues. The bust of one of these still remains (Fig. 93), in black granite, of glass-like polish (P.T. I. phot. xiii. 2). Another, also in black granite, is perhaps unique among Egyptian sculptures for having no back pedestal or pier, the whole body being admirably carved on all sides (P.T. I. phot. xiii. 3, 4); this was more complete in Burton's time, and is shown by his copy to belong to this king. Yet a third statue of grey granite is in evidence, by a piece of the base (P.T. I. ii. 8). All of these were barbarously ruined by Merenptah, who battered his name in upon the exquisitely finished surfaces. Near Tanis, at

Faqus, a red granite sphinx has been found, which is probably of Usertesén (A.Z. xxiii. 11).

Passing Heliopolis, above noted, and the temple of Memphis, which seems to have been completed before

Usertesen, a remarkable red granite obelisk is found in the Fayum, at Begig. This differs from all other monoliths in Egypt, being rounded at the top with a cylindrical curvature parallel with the wide face (L.D. ii. 119). The steles of Medum are rounded with a spherical curve, which shows of course most prominently on the broad face; whereas this is rectangular in front view, and only curved in side view. The subject of decoration is also peculiar. The upper part of the face is occupied by five courses of scenes, and 13 lines of hieroglyphs below them. Each course re-



FIG. 94.—Road up to tomb of Ameny, Beni Hasan.

presents Usertesen adoring four divinities, twenty in all. The block was 41 feet high and 7 and 4 feet at the base; but it is now overthrown and broken in two. This shows that the Fayum continued to attract attention, Amenemhat I. having begun to occupy it, and Amenemhat III. having specially developed it, as we shall notice further on.

Next, at Beni Hasan (Fig. 94), is one of the fullest records of this time, in the tomb of Ameny. He was the hereditary noble of the Oryx nome, and succeeded to the

princedom in the eighteenth year of Usertesen I., as his tomb is dated in the twenty-fifth year of his rule and the forty-third of the reign of the king. He records: "I followed my lord when he sailed up the river to overthrow his enemies in the four foreign lands (probably Upper and Lower Nubia, east and west). I sailed up as the son of the prince (*i.e.* before the eighteenth year of the king), royal seal-bearer, commander of the soldiers of the Oryx nome, as a man replaces an aged father, according to the favours of the king's house and his love in the palace. I passed through Ethiopia in sailing southward, I removed the boundary of the land. I brought the tribute of my lord, my praise reached unto heaven. His majesty arose, and went in peace. He overthrew his enemies in Kush. Following his majesty, I returned, sharp of face, and without loss of my soldiers.

"I sailed up the river to bring treasures of gold to the majesty of Usertesen I. I sailed up with the hereditary prince, the eldest son of the king, of his body, Ameni (afterwards Amenemhat II.). I sailed up with 400 men of every chosen man of my soldiers. Returning in peace, they had not diminished. I brought the gold appointed to me, and I was praised for it in the palace, and the king's son thanked God for me.

"I arose and sailed up the river to bring treasures to the city of Koptos with the hereditary prince, the vizier Usertesen, I sailed up with 600 men of every valiant man of the Oryx nome, I returned in peace, and my army safely, I had done all that was ordered to me.

"I was in favour and much beloved, a ruler who loved his city. Moreover, I passed years as ruler in the Oryx nome. All the works of the king's house came into my hands. Behold he set me over the gangers of the lands of the herdsmen in the Oryx nome, and 3000 bulls of their draught stock. . . . Not a daughter of a poor man did I wrong, not a widow did I oppress, not a farmer did I oppose, not a herdsman did I hinder. There was not a foreman of five from whom

I took his men for the works. There was not a pauper around me, there was not a hungry man in my time. When there came years of famine, I arose. I ploughed all the fields of the Oryx nome, to its southern and its northern boundaries. I made its inhabitants live, making provision for them; there was not a hungry man in it, and I gave to the widow as to her that had

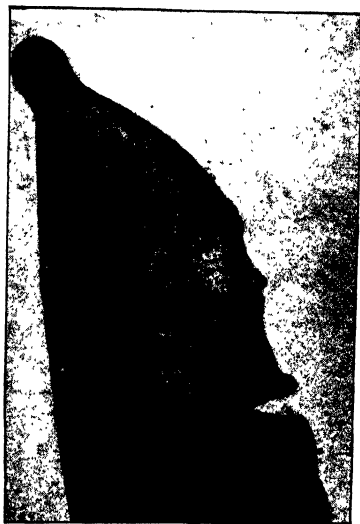

FIG. 95.—Useratesen I., Abydos.

a husband : nor did I favour the elder above the younger in all that I gave. Afterward the great rises of the Nile came, producing wheat and barley, and producing all things, and I did not exact the arrears of the farm” (G.B.H. 25).

Here we have a picture of the occupations of the old feudal families of the various districts, tamed down and

kept under restraint by the power of the Theban kings; and employed in various public missions and wars, or else ruling their districts with care and justice.

At Abydos Usertesen was engaged on the temple of Osiris. Mentuhotep, the chief architect, was also governor of the east desert or red country, and a man of almost royal importance; among other works he built the temple of Osiris, and sunk a well (M.A. 617). These are probably the same as works mentioned by an inferior official, Mery (P.R. ii. 104), who prepared a noble place of eternity for Osiris, with a wall that



FIG. 96.—Usertesen I., Koptos.

pierced heaven, a well that reached down to the river, and gates that hid the sky. And this same well appears to be mentioned by Strabo, who describes a well at Abydos, with a descent roofed by admirable blocks of stone. A statue of Usertesen has also been found there (Fig. 95) (M.A. 345; M.A. ii. 21; R.A. phot. 111, 112). This building is referred to in the XIIIth dynasty, when the colours and ornaments of Usertesen I. were restored; and in the XXth dynasty, when "the house of Amen dated from Usertesen I. and needed to be renewed" (B.H. 142, 133).

The deserts were revisited as under the previous kings, and an inscription at Hammamat (My. E. 326) shows the royal power. At Koptos a portion of a noble gateway and blocks of sculpture indicate that User-

tesen much adorned, if he did not rebuild, the temple. He is shown adoring Min, Bast, and Nekhebt in different parts (Fig. 96).

At Karnak the works begun by Amenemhat were carried on by his son. A block bears his name, and others, apparently of the same work, are dated in the twentieth year (M.K. 8 a-c).

Farther south, at Shekh Taud, the Greek Tuphion, opposite to Erment, was found a red granite table of offerings (now in G. Mus.; A.Z. xx. 123). Beyond that, at Hieraconpolis, in the mounds of the town were found polygonal columns of this king (My. E. 508).

At the cataract are some rock inscriptions, dated in the first year (P.S. 271), thirty-third year (L.D. ii. 118 c), forty-first year (P.S. 91), and two undated (P.S. 113, 273).

But the important memorial in the south is the tablet from Wady Halfa (now in Florence), which records the conquest of several negro tribes, Kas, Shemyk, Khesaa, Shat, Akherkin, etc. (S. Cat. F. 1542). Unfortunately the front edge of the inscription is broken; but a fragment with the date of this expedition in the eighteenth year has been lately recovered by Captain Lyons, who has also found another tablet (now in Oxford, S.B.A. xvi. 16), and has examined the brick temple of this king at Wady Halfa.

Several private monuments are dated in the king's reign; and the following persons are more or less of interest—

Khnem'nekht was born in first year of Amenemhat, and dated his stele in seventh year of Usertesesen, when he was therefore 27 years old, at Abydos (A.Z. xix. 116).

Hor, priest of the pyramid Ka'nefer of Amenemhat I., dated his stele in ninth year of Usertesesen (P.R. ii. 108).

Heru'em'hat, an unusual name (Leyden, Lb. D. 102).

Mery, builder of temple of Abydos, ninth year (P.R. ii. 104).

Up'uat'aa, stele double dated in the forty-fourth year, and second year of Amenemhat II. (Leyden, L.A., x.).

Mentuhetep, builder of the temple at Abydos (M.A. 617).

Hepzefa, of the great tomb at Asyut (G.S. iv.).

Of small objects, there are some shells inscribed with the royal names (B. Mus.); a carnelian statuette was in the Louvre, but was stolen in the Revolution of 1830; a glazed vase was found at Abydos (M.A. 1466); a piece of a vase of the blue-white marble, characteristic of this age, bears the name (B. Mus.); there are also many scarabs, some plain, others of the symmetrical style of ornament, and with scroll-work; also a few cylinders of glazed stone.

An interesting weight, bearing the name of the king, belonged to a goldsmith, Hormera (Vienna, Rec. xii. 10); it weighs 853 grains, or four of the gold standard of 213 grains. Probably the plaque with the same name (formerly in the Palin Coll.), is another weight of this person.

XII. 3.
NUB·KAU·RA

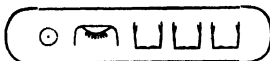

about
2716-
2681 B.C.

AMENEMHAT II.



Pyramid	<i>Kherp</i>	(Site unknown).
Sarbut el Khadem	Temple	(My. E. 351).
Dehdamun	Granite altar	(A.Z. xxiii. 12).
Nebeshch	"	(P.T. II. ix. 1).
Beni Hasan	Khnemhotep tomb	(G. Bh. 58).
El Bersheh	Colossus tomb	(L.D. ii. 134-135).
Abydos	Sahathor stele	(A.Z. xii. 112).
Wady Gasus	Inscription	(A.Z. xx. 203).
Hamamat	"	(My. E. 326).
El Hosh	Tablet	(My. E. 512).
Aswan	Inscriptions	{ (L.D. ii. 123, a, b, c).
Cylinders and Scarabs		{ (L.A. x. 4).



FIG. 97.—Scarab
(G. Coll.).

As we have already seen, the new king began his reign at least two years before the death of Usertesen I. He appears to have kept up the traditions of the dynasty, but no great events marked this time.

The pyramid of this king was named *Kherp*, as shown by a stele of a priest of the pyramid (B. Mus.; A.Z. xii. 112). And as no two pyramids are known to have the same name, this serves to identify the king with an abbreviated form of his name, where Sa'hathor says that he was beloved of Nub·kau·ra, and was sent to do the work for the temple of Amenu at the *Kherp* pyramid (S.B.A. xiv. 39). Thus Amenu (and probably Amenemhat) was a recognised familiar name for the longer Amenemhat, for royal persons, as it was also in private life at Beni Hasan.

Nub·kau·ra appears to have formally established the mining works at Sarbut el Khadem (Fig. 98), and to have founded the temple there (My. E. 351). But in Eastern Egypt his work is not found at the great centres of Tanis or Bubastis, but only at the lesser sites, which perhaps he was the first to adorn. At Dehdaman, near Faqus, a granite altar of his was found by an Arab of the district, and sold to the Ghizeh Museum; it is of veined red granite, and very finely worked (A.Z. xxiii. 12). And in the same region, at Nebesheh, were the remains of an altar of black granite, which bore a remarkable added inscription of later date by a royal seal-bearer (P.T. II. ix. 1).

But at Beni Hasan is the principal inscription of this reign in the tomb of Khnem·hotep (Tomb 3). He states that Nub·kau·ra raised him to the place of his father as prince in the nineteenth year, in the town of Menat-Khufu. He then describes all the religious and funerary foundations that he established, both for his father and for the various festivals. He also arose to favour and power at the court. His son was advanced to be ruler of the Jackal nome, and the boundaries and details were settled by the king. His other son was also advanced. And lastly, he describes a grand mortuary chapel for his father, which he had constructed (G. Bh. 61). All

of this is quite different from the labours of the earlier reigns. No great settlement of the country, no foreign warlike expeditions, break in on the prosperous tranquillity of either sovereign or subject.

The tombs of El Bersheh are now of importance at this period; and the tomb of Tahuti-hotep bears



FIG. 98.—Sarbut el Khadem.

the celebrated scene of the dragging of a colossus on a sledge by gangs of labourers (L.D. ii. 134, 135).

Abydos continued to be of the greatest importance for burials. The tomb of Sa-hathor there records that he was beloved by the king Nub·kau·ra, and was sent on many missions. Among others he went to the town of the *kherp* pyramid of Amenu to do work on

fifteen statues of hard stone, which he finished in two months. In his youth he worked the mines in Nubia, and made the chiefs have gold washed for him (A.Z. xii. 112). The other tablets of the tombs record nothing of importance in this uneventful reign.

The desert, however, was worked as before. At Wady Gasus a small temple existed, from which two steles have come, one of this reign, one of the next. The first records how it was put up by a noble named Khenti'kheti'ur, seal-bearer, keeper of the storehouse, who came in peace from Punt with his boats in the twenty-fourth year (A.Z. xx. 203).

In Hammamat there is said to be an inscription also of this king (My. E. 326). And one has been seen at El Hosh, near Silsileh, dated in the seventeenth year (My. E. 512).

At Aswan there are a few inscriptions of this time, but none of historical import (L.D. ii. 123, a, b, e).

Among the private tablets, one of Mentu'sa (B. Mus., Sharpe, i. 83) records that he was born in the first year of Amenemhat I., and erects his tablet in the third year of Amenemhat II., when he must therefore have been 52 years old.

The end of this king, according to Manetho, was that he was slain by his chamberlains: an inglorious end to a tranquil life of easy prosperity.

There are many small amulets, cylinders, and scarabs; but the workmanship shows a great falling off from that of the previous reigns, and the old high level of delicate and regular work was never reached again in this dynasty.

The scarabs of Sankh'ka'ra, Amenemhat I., and Usertesen I. are perhaps unrivalled in any other period for their finish.

XII. 4. KHA·KHEPER·RA

about 2684-
2660 B.C.

USERTESEN II.

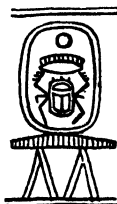

Pyramid	<i>Hotep</i>	Illahun.
Tanis	Queen Nefert	(P. T. II. xi. 171).
Memphis	Inscription	(M. D. 27 a).
Illahun	Pyramid and Temple	(P. I. ii. xiv.).
Ahnas	Blocks	(N. A. i.).
Beni Hasan	Khnem hotep	(N. Bh. xxxviii.).
Qosēr	Stele	(A. Z. xx. 204).
Hieraconpolis	Statue	(Rec. x. 139).
Aswan	Stele	(L. D. ii. 123 d).
Statues	Berlin and Louvre.	
Scarabs, cylinders, etc.		
<i>Queen</i> —Nefert	(P. T. II. xi. 171).	
<i>Daughters</i> —Atmu neferu (?)	(P. I. xii. 6, 7, 8).	
	Sat 'hathor (Dahshur).	
	Sent's'senb (Dahshur).	

FIG. 99.—Cylinder
(B. Mus.).

Of this king we have fortunately found the pyramid and pyramid-town, which gives a more complete idea of the civilisation of this reign than we have yet obtained of most other periods. The pyramid of Illahun is at the mouth of the channel in the desert which leads into the Fayum; and we have already noticed how the kings of this dynasty have left their remains in the Fayum, and organised that province. Usertesen II. placed his pyramid where it was still in the Nile valley; but from the top of it the Fayum is visible on looking up the channel between the desert slopes.

The pyramid is peculiar (Fig. 100); the lower part of it is of unmoved rock, which has been isolated from the hill by a deep and wide cutting. Upon that rock walls of large blocks arise, both diagonal and square with the faces, and between these walls is filled in a

brick pyramid. The outside was cased with fine limestone, like the other pyramids. It seems that the pyramids of the earlier kings had fallen a prey to violence already; the signs of personal spite in the destructions are evident (P.P., 2nd edition, 66, 67). Therefore Usertesen II. determined to abandon the old system of a north entrance in the face, and to conceal the access to the interior by a new method. The chambers were all excavated in the solid rock without any upper opening, so that they could not be reached

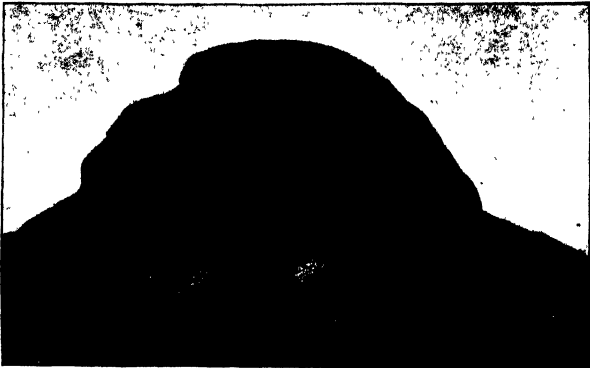

FIG. 100.—Pyramid of Illahun from the south (excavations in chips around it).

by tracking between the rock and the building. And the entrance was by a shaft outside of the south face of the pyramid. Two shafts were made, and but for such a doubling of these weak points, for the convenience of access of the workmen, it might have remained inviolate (Fig. 101). The main shaft was so carefully concealed under a deep mass of rubbish in the plain, that it has never been found; but the small secondary shaft was only covered by the pyramid pavement, and was opened up when that was removed by Ramessu II.

The interior has a long sloping passage, rising upwards, so that water could not flood the sepulchre; this passage leads to a large chamber lined with limestone, and that opens into another lined with red granite, in which stands the sarcophagus (P.I. 1-4). There is a curious passage cut in the rock passing around the granite chamber, as if to prove to any searcher that no other way opened out of that. In the chamber stood the alabaster altar of offerings, finely inscribed to Osiris and Anubis (P.I. iii.). The red granite sarcophagus is exquisitely wrought; the

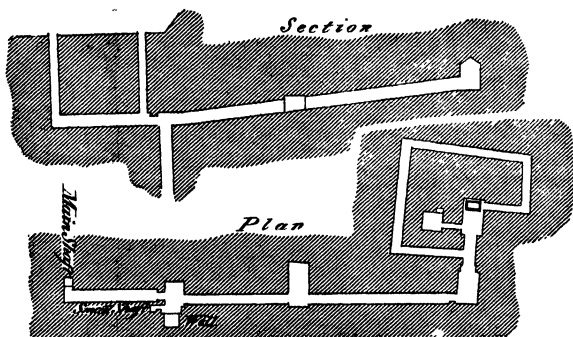

FIG. 101.—Section and plan of passages in pyramid of Illahun.
Scale $\frac{1}{1000}$.

errors of flatness and straightness being matters of thousandths of an inch (P.I. 3). It has a peculiar lip around it, which has given some weight to the theory that it has been reset in a new position, and that it had been originally sunk in the floor. But any such theory of arrangement requires us to suppose a great amount of reconstruction, of which there is no evidence whatever.

Against the east face of the pyramid was a shrine for the worship of the king, richly carved and painted. The whole of this was smashed up by the masons

of Ramessu II., who have left his name written on a block. And the stonework from here appears to have been removed to Ahnas, where the name of Usertesen II. occurs on a block reworked by Ramessu II.

About a mile to the east of the pyramid, opposite the middle of the face, is a temple of larger size. This stands on the edge of the desert hills, and would probably be the public temple, while the shrine by the pyramid might be only for the priests. This had all been destroyed, and only a coat of chips covered the ground, many of them showing brilliant work and colouring. A basalt statue had been here, of which only a flake of the thigh remained; also a shrine of red granite, and a smaller statue of black granite, of which chips were found. In the centre of the area was a pit in the rock with foundation deposits (P.K. 22).

Near the large pyramid stood a smaller one, the chambers of which are also cut entirely in the rock, without any opening but the entrance, which must be at some distance, as it was not found in a wide clearance around the site. A fragment of the shrine gives the name of a princess beginning with Atmu, probably Atmu-neferu (P.I. xii. 6, 7, 8).

By the site of the larger temple is the town of the workmen who built the pyramid and temples; this place was known as "Hat-hetep-Usertesen," and is now named Kahun. Part of it is entirely denuded away, but it yet occupies about 18 acres, within which are over two thousand rooms. All of these have lately been cleared, and the plans of the streets and houses completely published (P.I. xiv.). From this we learn the details of the houses of that age; both the mansions of the high officials, and the rows of little dwellings for the workmen. The objects found in this town throw much light on the civilisation; and the papyri form the majority of those known of this age. The town appears to have been half deserted after the pyramid and temple were finished; and the

inhabitants who were left used the empty houses for rubbish holes. But it seems that few, if any, people remained there during the troubles of the Hyksos period. A few houses were occupied under the beginning of the XVIIIth dynasty, and then it was left to the jackals, and gradually weathered down.

At Beni Hasan is one of the most interesting records of this age. Khnem·hotep is represented as receiving a group of thirty-seven Aamu of the eastern desert, bearing a tribute of *kohl*, or eye paint. The figures of these foreigners are very important, as showing what kind of civilisation was already spread in the countries between Egypt and Mesopotamia. The royal scribe, Neferhotep, who introduces the party, bears a tablet on which is written, "Year six, under the majesty of Horus, the guide of the two lands, the king of Upper and Lower Egypt, Kha·kheper·ra, the number of Aamu brought by the son of the noble Khnem·hotep, on account of the *kohl*, Aamu of Shu, number amounting to 37" (N. Bh. xxxviii.). Khety, the overseer of the huntsmen, follows the scribe, and behind him come the foreigners. First is the chief, leading a tame ibex (Fig. 102); his title and name is before him, *heq setu Absha* (N. Bh. xxviii.). We have already seen how important a *heq setu* was, in considering Khyan in the VIIIth or IXth dynasty, who occupied part of the Delta and adopted the dignity of an Egyptian king. Here again the rich clothing of these people shows that they were not mere wandering Bedawin, clad in skins; on the contrary, their gaily patterned garments remind us of the rugs of Persia in the design. They cannot have attained the means and the taste for such ornament in a savage and wandering life; and we may safely infer that they belong to a region less sterile than the bare desert of the Red Sea. Rather may we connect them with Northern Arabia, the region which the power and monuments of Khyan lead us to regard as the home of the *heq setu*, or prince of the hill

country. The chief's face is obviously Semitic, being closely like that of the Bedawin of the present day ; the narrow line of beard down the jaw, rising toward the corner of the mouth and then sloping away to the chin, the long aquiline nose, and the general expression, are all familiar in the Arab face. The same Semitic origin is pointed out by the name Absha, which is equal to the Hebrew Abishai, "the father of a present"; and it is likely that this was not his real name,



FIG. 102.—Chief and women of Aamu (from Beni Hasan I.).

but rather a name given him by his people in consequence of his coming to Egypt with a present or tribute to the Egyptians ; just as Arabs would now name a man who brought presents as "the father of presents."

After the chief comes a follower leading a gazelle ; then four armed men with bow, boomerangs, and spears ; two children on an ass laden with rugs ; a boy

with a spear; four women gaily dressed in coloured garments, patterned with stripes, chequers, and frets; another ass laden with baggage, a spear, and a shield; a man with a water-skin on his back, playing on a lyre; and lastly, a bowman with a boomerang (N. Bh. xxxi.). Here is no sign of inferior civilisation. The clothing is quite as much as the Egyptians used, the decoration of it is more profuse than on the Egyptian dress, the arms are the same as in Egypt, the bow and boomerang, and the spear is not common so early in Egypt; the sandals are as good as the Egyptian pattern, and the women have socks. Though a different civilisation, it is no way inferior to the Egyptian in the arts of life which were needful to such a people. These were the Aamu with whom the Egyptians warred with such large armies under Pepy I.; and who appear to have invaded Egypt and held the country in the time of the IXth-Xth dynasty.

At Qosēr one of the steles is dated under Usertesēn II. (A.Z. xx. 204). At Hieraconpolis a statue of this king in black granite has been found, now in the Ghizeli Museum (Rec. x. 139). And at Aswan is a fine stele of a local noble, Mentuhotep, dated in this reign (L.D. ii. 123 d). The tomb of Sarenput at Aswan, and his statue of black granite (B. Mus.), also belong to this reign, as his father was called after Amenemhat II. (Rec. x. 189).

In Berlin is a statue dedicated by an official, Ser (W.G. 250); and in the Louvre a carnelian statuette is said to exist, but is not in the catalogue. It is probably a false reference for the stolen statuette of Usertesēn I. (see De Rougé, Notice des Monuments, 16).

Of scarabs and cylinders there are several of this reign; ten having been found in his pyramid-town of Kahun alone.

His queen was named Nefert, as we learn from her grey granite statue at Tanis (Fig. 103) (G. Mus.; P.T. II. xi. 171). She is represented seated on a throne, with her wig brought down in two masses to the

breasts, where each ends in a spiral curl. On the bosom is a pectoral, on which is the king's name between two vultures on the *nub* sign. On the throne are the titles, "The hereditary princess, the great favourite, the greatly praised, the beloved consort of the king, the ruler of all women, the king's daughter of his body, Nefert." The title ruler, or princess, of all women is

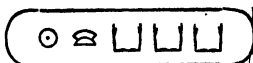

FIG. 103.—Queen Nefert.

peculiar, and suggests that the queen had some prerogatives of government as regards the female half of the population.

The small pyramid at Illahun seems to have been for a princess named Atmu . . . ; and, as many names in this age are compounded of the names of deities and *neferu*, so this may well have been Atmu·neferu, "the beauties of Atmu" or Tum. For the other two daughters see the next reign.

XII. 5. KHA·KAU·RA



about

2660-

2622

B.C.

USERTESEN III.



Pyramid, Dahshur, N. brick.

Tanis	Architrave	(P. T. I. ii. 7).
Nebesheh	Statue	(P. N. ix. 2).
Khataaneh	Jambs	(A. Z. xxiii. 12).
Mokdam	Statues	(N. A. iv. xii.).
Bubastis	Architraves	(N. B. xxxiii).
Abydos	Statue	(M. A. 346).
Hammamat	Inscription	(L. D. ii. 136 a).
Gebelen	Base of statue	(G. Mus.).
Aswan	Inscriptions	(L. D. ii. 136 c).
Elephantine	Tablet	(A. Z. xiii. 50).
Sehel	Inscriptions	{ (L. D. ii. 136 b). (Rec. xiii. 202).
Bigeh	Statue	(L. L. 120).
Semneh	Fort and temple	(L. D. I. 111-112).
Kummeb	"	(L. D. I. 111-112).
Scarabs and Cylinders		
Queens—Henut·taui		Dahshur
Merseker?		(L. D. iii. 55 a).

FIG. 104.—Scarab
(P. Mus.).

The pyramid of this king is apparently the north brick pyramid of Dahshur, from the remains discovered around it by M. de Morgan in 1894. The arrangement is unlike that hitherto known at any pyramid. In place of the well descending on the south side as at the tomb of Usertesen II., there are wells just inside the corners of the peribolus wall on the N.W. and N.E.; and probably also at the other corners. These wells are connected with long galleries parallel to the peribolus; and chambers containing sarcophagi open from these galleries. Three named interments are already known. A queen, "*khnum nefer hest* Henut·taui," inscribed on a sandstone sarcophagus; this is probably the queen of Usertesen III., as she is queen consort at her death, and is not called royal mother. A princess, "king's daughter Sent's·senb," inscribed on a lime-

stone sarcophagus, probably a daughter of Usertesen II., and sister of Usertesen III., judging by the next example. And a princess, Sat'hathor, whose jewellery was found in a casket overlooked by the ancient plunderers. Her pectoral bears the name of Usertesen II., while a scarab has the name of Usertesen III.; hence she was probably daughter of the former and sister of the latter, who buried her in his pyramid mausoleum. This jewellery is a treasure only paralleled



FIG. 105.—One of the royal pectorals inlaid with stones, Dahshur pyramid mausoleum.

by that of Aah'hotep. A pectoral of gold is richly inlaid with minute work in carnelian and light and dark blue stone or paste; the design is like that of the pectoral on the breast of Nefert, her father's queen (see the Tanis statues in the Ghizeh Museum), the cartouche of Usertesen II., surmounted by *neb neteru*, and supported on either side by a hawk on *nub*, with the sun and uraeus behind. Bracelets, necklaces of gold cowries, pendants of lions and lions' claws in gold, and

strings of beads in gold, amethyst, and emerald, make up this splendid equipment of a princess.

Having the north brick pyramid of Dahshur thus fixed to Usertesen III., it is possible that the two stone pyramids there belong to Amenemhat I. and Usertesen I.; as the Lahun pyramid is of Usertesen II., and the Hawara pyramid of Amenemhat III., the burials of the dynasty would be thus nearly accounted for.

The name of this king in the Greek lists, Lakheres, is quite accounted for by the corruption of X into Δ, by omission of the top; thus altering Kha·kau·ra, or Khakeres, into Lakheres.

In the Delta, Usertesen seems to have been very active as a builder. At Tanis an architrave of red granite bears his name (P.T. I. ii. 7); at Nebesheh stood statues in yellow quartzite, one of the thrones of which is preserved (B. Mus. ; P.N. ix. 2); at Khataaneh are the jambs of red granite, lying by the lintel of Amenemhat I. (A.Z. xxiii. 12); at Tell Mokdam are the bases of two statues (N.A. 29, iv. xii.); at Bubastis he appears to have rebuilt the temple, there being several blocks and architraves bearing his name, and a portion of a long inscription about a war against the negroes, probably also of this time (N.B. 10, xxxiii. xxxiv.). Memphis appears to have been passed over in this reign. At Abydos is a red granite statue in the temple (M.A. 346).

At Hammamat we meet an inscription which shows that Herakleopolis, now Ahnas, was adorned by him: "In the fourteenth year, the eighteenth of Khoiak, in the reign of Kha·kau·ra, loving the god Min of Koptos, behold his majesty ordered the going to Rohanu to bring the monuments which his majesty ordered him to make for Hershef, lord of Herakleopolis (even the living chief Kha·kau·ra ever living!), in good Bekhnu stone. He sent me as overseer of works on account of my excellence, a true commander, known to his lord. He overthrew the foreigners and the Troglodytes, and brought excellent tribute of the Tehenu (Libyans); he who says what is good and reports what is desired,

Khuy, son of Hepy." The construction of this inscription is rather confused.

At Gebelen the base of a statuette of this king was found (G. Mus.). Thebes appears to have been passed by, and all the energies of the reign were concentrated on the complete subjugation of Nubia. At Aswan are inscriptions of the sixth year (a tablet of Aay, P.S. 262) and of the twelfth year (P.S. 340). At Elephantine was a tablet recording some constructions in the eighth year of this reign (B. Mus. ; A.Z. xiii. 50).

On the island of Sehel, by the cataract, is a tablet representing the goddess Anqet giving life to Usertesen, and stating that he made monuments to her, and also the canal, "most excellent of ways of Usertesen." Another tablet of great interest represents there the goddess Sati giving life to Usertesen, and states that "in the eighth year, under the majesty of Kha·kau·ra, living for ever, ordered his majesty to be made a canal anew ; the name of this canal is the 'most excellent of ways of Kha·kau·ra ever living.' Then his majesty sailed southward to crush Ethiopia the vile. Length of this canal, 150 cubits ; breadth, 20 cubits ; depth, 14 cubits." This canal was used again by Tahutmes I., and was cleared and reopened by Tahutmes III., who gave the standing order, "The fishers of Elephantine shall cut this canal every year" (Rec. xiii. 202).

No modern canal has been attempted in this place ; and instead of a canal 34 feet wide and 24 feet deep, up which any Nile boat could pass, we have resorted to a railway with a shift of cargo at each end of it.

This canal was a part of the great preparations for the conquest of Nubia, and Usertesen left his statue on the isle of Bigeh, above the cataract, in honour of the gods of the region (L.L. 120). Pressing on, he defeated the negroes in different campaigns, of which we have records of the eighth, sixteenth, and the nineteenth years. On a tablet set up at Semneh (Fig. 106), we have a characteristic inscription, showing much both of the king and the people. "In the sixteenth year, the month Phamenoth, made his majesty the southern

boundary unto Heh. I (the king) made my boundary south of my father's ; I did more than was committed to me by them ; I the king both say and did it. It was the device of my heart, which was done by me ; eager to capture, powerful to succeed, and not slothful ; one in whose heart there is a word which cravens know not. Giving no satisfaction to the enemy which invades him ; but invading the invader, and leaving alone the man who lets him alone. Answering a word according to its result ; for a man who remains silent after an attack, encourages the heart of the enemy. Eagerness is



FIG. 106.—View of Semneh (from L. D. ii. 112).

valiant, and base is the coward who is driven back. It is truly a coward who is oppressed upon his own boundary ; for the negro obeys as soon as the lips are opened ; an answer makes him draw back ; he turns his back to the impetuous. They are not valiant men, they are miserable, both tails and bodies (a joke at the hide girdles and tails, which always amused the Egyptians) ; my majesty saw it myself ; it is no fable. I captured their wives, led away their peoples ; I went out to their wells (in the desert valleys), and smote their cattle, and destroyed their corn, and set fire to it. By my life and my father's life, what I say is in truth.

“ And every son of mine who confirms this boundary which my majesty has made, he is my son, he is born of my majesty, a son who avenges his father (like Horus), who confirms the boundary of him who begat him. But he who destroys it, even who fights not for it, he is not my son, he is not one born to me. Moreover, my majesty caused a statue of my majesty to be made upon this boundary, which my majesty made from the desire that ye should fight for it.”

These conquests in Nubia were permanently secured by thus pushing back the frontier of Egypt to above the Second Cataract, and building on the hills of Semneh and Kummeh two forts commanding the river, about thirty miles above the cataract. The fort of Semneh is on the west bank, bordering on the river, and on an almost inaccessible height of platform, artificially raised, and containing a temple. That of Kummeh, on the east bank, is on a natural height, which is very strong, and also contains a temple (L.D. i. 111-112; Ms. A. 29, 30). A decree for the frontier guards was placed at Semneh: “ This is the southern frontier; fixed in the eighth year of the reign of his majesty Kha'kau'ra, ever living. Let it not be permitted to any negro to pass this boundary northward, either on foot or by boat; nor any sort of cattle, oxen, goats, or sheep belonging to the negroes. Except when any negro comes to trade in the land of Aken, or on any business, let him be well treated. But without allowing any boat of the negroes to pass Heh northward for ever ” (L.D. ii. 136 i).

In after ages this king was revered as the founder of Ethiopia, and the later kings of the XVIIIth dynasty specially adored him in their temples at Semneh, Kummeh, Dosheh, Shatawi, Ellesieh, and Amada.

Some private inscriptions of this reign also remain at Semneh and Kummeh (L.D. ii. 136 d-g).

A curious illustration of the worship of the kings is preserved in a long hymn to Usertesen III. on a papyrus found at Kahun. After an opening adulation of titles comes the poetical part of the hymn of praise, stanza

after stanza of ten lines, the most perfect example of Egyptian poetry that we know

I.

- 1 Twice joyful are the gods,
thou hast established their offerings.
- 2 Twice joyful are thy princes,
thou hast formed their boundaries.
- 3 Twice joyful are thy ancestors before thee,
thou hast increased their portions.
- 4 Twice joyful is Egypt at thy strong arm,
thou hast guarded the ancient order.
- 5 Twice joyful are the aged with thy administration,
thou hast widened their possessions.
- 6 Twice joyful are the two regions with thy valour,
thou hast caused them to flourish.
- 7 Twice joyful are thy young men of support,
thou hast caused them to flourish.
- 8 Twice joyful are thy veterans,
thou hast caused them to be vigorous.
- 9 Twice joyful are the two lands in thy might,
thou hast guarded their walls.
- 10 Twice joyful be thou, O Horus! widening thy boundary,
mayest thou renew an eternity of life.

II.

- 1 Twice great are the owners of his city,
for he is a multitude and an host.
- 2 Twice great are the owners of his city,
for he is a flood-gate pouring forth streams of its water-
- 3 Twice great are the owners of his city, [floods.
for he is a bower, letting every man lie down in the mid-
- 4 Twice great are the owners of his city, [day heat.
for he is a screen like walls built of the sharp stones of
- 5 Twice great are the owners of his city, [Kesem.
for he is a refuge, shutting out the robber.
- 6 Twice great are the owners of his city,
for he is an asylum, shielding the timid from his enemy.
- 7 Twice great are the owners of his city,
for he is a shade in the high Nile to provide coolness in the
- 8 Twice great are the owners of his city, [summer.
for he is a warm corner of shelter in the winter.
- 9 Twice great are the owners of his city,
for he is a rock shielding from the blast in the stormy day.
- 10 Twice great are the owners of his city, [his boundary.
for he is as the goddess Sekhet to the foes who tread on

III.

- 1 He has come to us, he has taken the land of the well,
the double crown is placed on his head.
- 2 He has come, he has united the two lands,
he has joined the kingdom of the upper land with the
- 3 He has come, he has ruled Egypt, [lower.
he has placed the desert in his power.
- 4 He has come, he has protected the two lands,
he has given peace in the two regions.
- 5 He has come, he has made Egypt to live,
he has destroyed its afflictions.
- 6 He has come, he has made the aged to live,
he has opened the breath of the people.
- 7 He has come, he has trampled on the nations,
he has smitten the Anu, who knew not his terror,
- 8 He has come, he has protected (?) his frontier,
he has rescued the robbed.
- 9 He has come
of what his mighty arm brings to us.
- 10 He has come, we bring up our children,
we bury our aged by his good favour.

The remaining stanzas are incomplete, but we can see through this a real national fervour of delight at the repression of the negro tribes, and the establishment of security and safety in the country.

There are many scarabs and cylinders of this reign in various collections; mostly of rather rude work.

The queen in the Dahshur mausoleum is named Henut-tai, and there is a probability that a queen of Usertesen was named Merseker, as she is adored by Tahutmes III. at Semneh in the same inscription with this king (L.D. iii. 55 a); but no other trace of her has been found.

XII. 6. MAAT·EN·RA

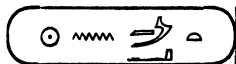

about
2622—
2578
B. C.

AMEN·EM·HAT III.



Pyramid and temple, Hawara (P.K. ii.-v.).

Sarbut el Khadem	Shrine, etc.	(L.L. 301).
Wady Maghara	Inscriptions	(L.D. ii. 137).
Turrah	Stele	(L.D. ii. 143 i.).
Hawara	Pyramid	(P.K. ii.-v.).
Crocodylopolis	Pylon	(P.H. xxvii.).
Biahmu	Colossi	(P.H. xxvi.-vii.).
Hammamat	Inscriptions	(L.D. ii. 138).
Koptos	Vulture	
Hieraconpolis	Statuette	(Rec. x. 139).
El Kab	Stele	(W.G. 255).
Aswan	Inscriptions	(P.S. 84, 98, 151-3-4).
		(M.I. i. 14, 15, 27).
Kuban	Inscription	(L.D. ii. 138 g).
Kummeh	Inscriptions	(L.D. ii. 139).
Semneh	Nile levels	(L.D. ii. 139).
Statue	Berlin	(W.G. 260).
Statue	St. Petersburg	(Rec. xv. 136; i.-iv.).
Sphinx	Miramar Mus.	(Cat. xxix.).
Hawk (F.P. Coll.), scarabs, cylinders, etc.		
Papyri (Kahun Papyri xiv.).		
<i>Daughters</i> —Ptahneferu		(P.K.V.; Rec. x. 142).
Sebekneferu, queen later on.		



FIG. 107.—
Scarab.

The pyramid of Amenemhat was placed by him at the entrance to the Fayum province, which he so largely organised; from the top of it almost every part of the Oasis can be seen, out to the line of hills which bound its western border. It is also within sight of the cliffs on the eastern side of the Nile; and it thus links together the valley on which all the other pyramids look down, with this western Oasis which was the special care of this king (Fig. 108).

In construction this pyramid differs from all others known, but is more like that of Usertesen II. than any

other. The mass of it is entirely of brick, which was coated with fine limestone, like the other pyramids. The passages leading to the central chamber are peculiarly complex, and laboriously planned to defeat plunderers (Fig. 109). A new system was elaborated here, of dumb chambers, with gigantic sliding trap-doors in the roofs leading to further passages. The explorer who had found the entrance, in the unusual place on the south side, descended a long staircase, which ended in a dumb chamber.



FIG. 108.—Bust of Amenemhat III. from statue at St. Petersburg.

The roof of this, if slid aside, showed another passage, which was filled with blocks. This was a mere blind, to divert attention from the real passage, which stood ostentatiously open. A plunderer has, however, fruitlessly mined his way through all these blocks. On going down the real passage, another dumb chamber was reached; another sliding trap-door was passed; another passage led to a third dumb chamber; a third trap-door was passed; and now a passage led along past one side of the real sepulchre; and to amuse explorers, two false wells open in the passage floor, and the wrong side of the passage is filled with masonry blocks fitted in. Yet by some means the plunderers found a cross trench in the passage floor, which led to the chamber. Here another device was met. The chamber had no door, but was entered solely by one of the immense roof-blocks—weighing 45 tons—being

left raised, and afterwards dropped into place on closing the pyramid. This had been mined through,

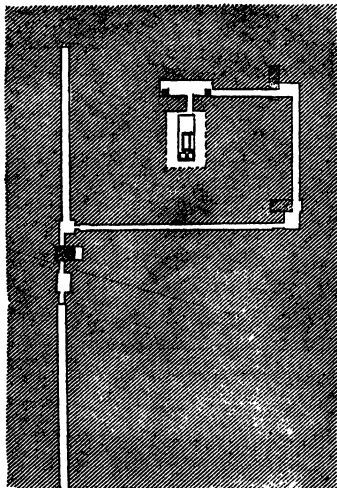

FIG. 109.—Plan of passages in Hawara pyramid. Scale 1000.

and thus the royal interments were reached. They had been entirely burnt; and only fired grains of diorite and pieces of lazuli inlaying showed the splendour of the decorations of the coffins.

The sepulchral chamber is one of the most remarkable works in Egypt. It is hollowed out in one block of glass-hard yellow quartzite, cut and polished with exquisite truth. It is over 22 feet long by about 8 feet wide inside, and over 2 feet thick, so that it must weigh about 110

tons. The roof of it is formed of three blocks of the same material, one of 45 tons, by which entrance was obtained, another larger, and a third smaller. All of this was built into a pit in the rock; a limestone sloping roof was placed over it, the beams of which are 7 feet thick; over that a brick arch was thrown, and the brick pyramid was built on it.

Inside the chamber is the sarcophagus of Amenemhat; flat around the sides, but with a projecting foot ornamented with panel pattern, and a curved lid. Subsequently a second coffin has been formed by building blocks between the royal coffin and the wall, and a second lid was put over the space, for covering a

second burial. Behind these two coffins stood two boxes of the same design, doubtless to hold the sepulchral vases, like the square box in the floor of Pepy's chamber. All of these objects were made of quartzite, some of it white and translucent; and there is no trace of inscription on this furniture, on the chamber, nor in any part of the pyramid. Below the water, which now half fills the chamber, were found pieces of the alabaster vases with the name of the king Maät'en-ra. And in the last of the passages was an alabaster altar and broken pieces of dishes, in the form of a half duck (all in G. Mus.), inscribed for the "king's daughter Ptahneferu," who was doubtless buried in the added sarcophagus space by the side of the king. This altar is peculiar for having figures of a great number of offerings, eighty-six of which bear names (P.K. 12-17, ii.-v.) (Fig. 110).

Adjoining the pyramid on the south side stood an immense building; part of which, at least, was the temple of Amenemhat. Some of the construction was due to his daughter Sebekneferu, who afterwards came to the throne (P.H. 6, xxvii. 12). This was the building so celebrated in classical times as the Labyrinth. The site of that has been much disputed; but Strabo states that it was on the canal between the Nile and Arsinoë; and by a papyrus found at Gurob, of Ptolemaic age, we know now that boats on the canal leading to Ptolemais in the Fayum, passed by the Labyrinth; every part of that canal has now been examined, without finding any trace of an early building except this great site.

All of the constructions have been removed for stone, and there is no trace of the extent of the building except the concrete or *beton* beds of the foundations, and the immense masses of chips over them, which have resulted from the destruction of the building by the quarriers of Roman age. The brick houses, mistaken by Lepsius for the Labyrinth, formed the village of the Roman age, built on the top of the fragments of the temple. The whole area of the build-

ing is about 1000 feet long and 800 feet broad, or enough to include all the temples of Karnak and of Luxor. From the scanty indications of the levels of the

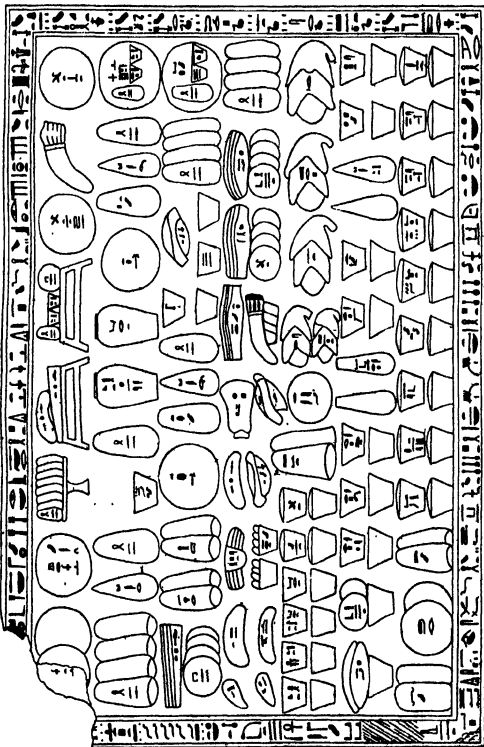

FIG. 110.—Alabaster altar of Ptahneferu, Hawara pyramid.

ground, and the fragmentary accounts of ancient authors, it appears as if the Labyrinth were a peristyle temple, with a central passage, and two great cross-

ways : the first crossway with courts or small temples opening on each side of it ; the second crossway being a hall with a long row of columns, and with courts opening on the farther side of it, much like the temple of Abydos (P.H. 4-8, xxv.). It has been supposed from the tales of Herodotos that the kings of the XXVIth dynasty had built here, either as restoring or adding to the older temples ; but there seems to be no trace of works of that date to be found here. Amenemhat continued to be honoured at Hawara until Ptolemaic times, as persons were named after him (P.H. v. 4, 11).

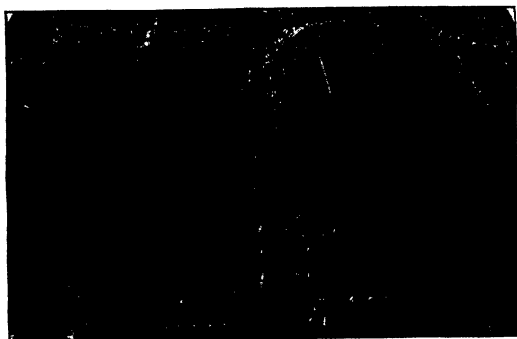

FIG. 111.—Two tablets of Amenemhat III., Wady Maghara.

We pass now to the geographical order of the monuments. In the Sinaitic peninsula Amenemhat developed his power. At the mines of Sarbut el Khadem he excavated a small rock temple, and placed steles outside of it (L.L. 301 ; L.D. ii. 137 ; C.N. ii. 691). In the Wady Maghara are also several inscriptions, in various years from the beginning to the end of this reign ; one records an expedition with 734 soldiers, to work the mines of copper and malachite (L.D. ii. 137 c-i) (Fig. 111).

The quarries of Turrah by Cairo have a fine stele of the king (L.D. ii. 143 i), showing that he obtained stone from there, probably for the Labyrinth. No such good stone could be had elsewhere in Egypt, as we learn by Una bringing from thence the best blocks for his tomb, against the Nile stream all the way up to Abydos.

The Fayum province was the great monument of Amenemhat III. The deep hollow in the desert,

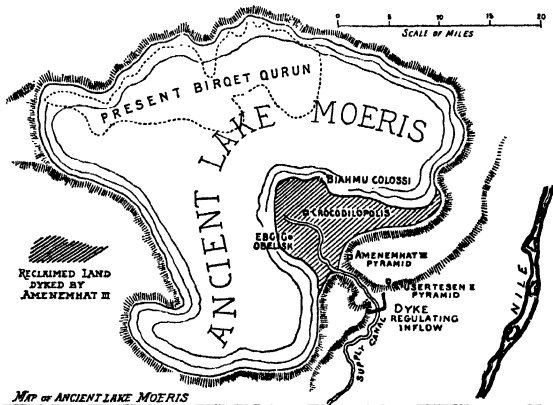

FIG. 112.—Map of the ancient Lake Moeris in the Fayum basin. The shaded part is that reclaimed from the lake by Amenemhat III.

descending over 120 feet below the sea level, was perhaps first produced by the upheavals and dislocations of the strata which caused the great fault of the Nile valley. But it is tolerably certain that from the earliest human period the Fayum was filled with water by the Nile, as there is a channel into it level with the Nile valley. This inflow of mud-bearing water had deposited beds of earth over the higher levels, where the Nile water first spread out into the lake. Of this

high level period many remains are seen, pebble beaches high on the dry side of the basin, and a quay of the town of Dimey on the western side, constructed in Greek times, but now dry far above the lake. There cannot be any question, therefore, as to this condition of things having existed (Fig. 112). The keeper of the Lake of the Crocodile or *Ta'she* is mentioned from the earliest times.

The first stage of interference with nature here seems to have been under Amenemhat I., as the earlier mentions of a town or district probably refer to the shores of the lake. His statue at Crocodilopolis (Medinet) shows that he had reclaimed a considerable surface from the lake; and a fragment of a gigantic thick dyke of earth, just beyond the ancient temple, may well be a part of his first dam, enclosing the higher part of the lake bed, and so bringing it into use for cultivation, or may even belong to some still earlier reclamation. This enclosure must have extended as far as Begig, three or four miles south-west of the temple, in the time of Usertesen I., whose obelisk lies there. Then under Amenemhat III. came the great extension of this damming-out system; and by means of a vast embankment, some twenty miles in length, an almost level area of about forty square miles, or over 20,000 acres, was secured from the lake, and became one of the most fertile provinces of the country. On the prominent northern corner of this great work (now known as Biahmu) were placed two massive platforms of stone walling, filled in with earth, from which arose two seated colossi of the king. These were monoliths about thirty-nine feet high, placed upon pedestals. Carved in the glassy quartzite, and polished brilliantly, they glittered as landmarks seen across the lake (P.H. 53-56, xxvi.). These were doubtless the statues on pyramids seen by Herodotos. The fragments of the statues, etc., are now in the Ashmolean Museum at Oxford. The great work of Amenemhat was not only the reclaiming of all this land, but also the regulation of the flow of the Nile

in and out of the lake. Down to the time of Herodotos this annual flow continued, and the lake served to hold part of the surplus of the high Nile, and to let that flow out again during the low Nile. Two causes, however, led to the abandonment of this system: first, the Nile always deposits more earth near its main bed than elsewhere, consequently the bed rises faster than the western side of the Nile plain, and hence there is now a difference of several feet across the Nile valley. So soon as this became considerable, it would be impracticable to get the water out of the Fayum again into the raised Nile bed. Secondly, the land was much needed for a new settlement of the Macedonian soldiers of Ptolemy Soter. Hence the inflow of the Nile was checked down to the amount actually required by the province, and the lake was gradually dried up under the earlier Ptolemies. Colonies of soldiers and their families were settled on the newly-reclaimed land, towns and temples sprang up as the lake receded, and it has been reduced to a low, though fluctuating, level ever since (P.H. 2). Amenemhat III. also rearranged the temple which his ancestor had built at Crocodilopolis; the red granite blocks of the pylon bear his name, though they have been re-used by later restorers (P.H. 57, xxvii.). The ancient name of the town, *Shed*, means the rescued or extracted, and thus refers to the extraction or saving of the land from the lake. The former theory of Linant, that the Lake Moeris was on the high plateau, was founded on a misconception of the levels, and of the physical features of the country, and needs no further consideration. As the remains within the dam—or *in* Linant's lake—are of the XIIth dynasty, and the remains outside of the dam are all Greco-Roman, it is obvious that the inside must have been dry land, while the outside was the lake, until late times.

The celebrated Lake Moeris was then the natural basin of the Fayum oasis, regulated and utilised by Amenemhat III. The extent of the basin up to Nile level was such that its circuit was equal to the coast:

line of Egypt, according to Herodotos, and this was approximately the case. The supposed extension of it into other desert valleys to the south-west is impossible during historical times, as the hills rise above the Nile level between the two depressions.

In the Wady Hammamat, we find that Amenemhat sent out an expedition to get stone, in his nineteenth year, for his buildings in the Fayum (L.D. ii. 138 c, e), apparently for the temple of Sebek at Crocodilopolis. The party made a causeway to draw the stones upon, and brought a statue of five cubits high. In the second year is a record of the overthrow of the negroes, and opening up of the road of the Aamu (L.D. ii. 138 a). These expeditions continued to need considerable forces, as in that of the nineteenth year "multitudes of soldiers, even two thousand," are mentioned. At Koptos a colossal vulture in hard limestone was dedicated by Amenemhat, "beloved of Sekhet" (now in G. Mus.).

The great centres of Memphis, Abydos, and Thebes seem to have been passed over by the king, only a few private dedications being found there; and we next meet with Amenemhat at Hieraconpolis, where a black granite figure of his was found (G. Mus.; Rec. x. 139). On the opposite bank, at El Kab, was a stele in the forty-fourth year, concerning the building of a wall (W.G. 255).

At Aswan are several private tablets dated in this reign, but none of historical value (P.S. 84, 98, 151, 153, 154). A stele of an official named Usertesén, at Kuban, opposite Dakkeh in Nubia, belongs also to this date (L.D. ii. 138 g).

But at Semneh and Kummeh a most interesting series of inscriptions is found, brief though they are, recording the height of the Nile. The great water-works of Amenemhat, for the regulation of the Nile by the intake and outflow at the Fayum, required an early notice of the rise and fall of the river; and official records were kept of it on the rocks, while probably

the news would be sent down by some signals from hill to hill, till it reached the lower country. These registers of the high Nile (see L.D. ii. 139) involve a difficult question, as they are about twenty-five feet above the present level of the river (L.L. 510). As the mouth sign beginning the inscription is written, bisected by the upper line in some cases, it seems as if it were the actual water level, and not a record placed at some determinate height, of ten or twenty cubits measured by a cord above the torrent of the full stream; otherwise such an explanation might seem the most feasible, as it would be easier to mark rocks, and examine old marks, on some spot well above the water. Such a possibility needs consideration on the spot. Granting, however, that these are the actual levels, the only view seems to be that the Nile has eroded its bed a depth of twenty-five feet at that point. It has often been suggested that the breaking through of barriers at Silsileh, or at Aswan, might affect it; but as those places are two or three hundred feet lower level, any change there would be as imperceptible at Semneh as a lock on the lower Thames would be at Oxford. Moreover, the early graffiti and tombs at Silsileh and Aswan are only fairly above the river at present, and show that no great change has occurred there in historical times. The Semneh levels, then, must point to a lowering of the bed in Upper Nubia, apart from Lower Nubia and Egypt; and this might occur by two causes, either by the erosion of the bed, or else by a slight elevation of the southern end of Nubia, thus making the water pour faster out of its channel, and so lie at a lower level. The gradient of the water in Nubia does not appear to exceed thirty seconds of angle, and hence a minute angular tilt of the country might flood up the upper valley, or let the water run faster out of it. Until a critical examination is thoroughly made of all the remains—especially trifling graffiti along the banks—in Upper Nubia, this vexed question must remain in abeyance (see on this L.L. 507-532).

Of other remains of Amenemhat, there is a fine statue usurped by Merenptah, possibly from Tanis, like other such usurpations, now in Berlin (W.G. 260); and also another statue at St. Petersburg (Rec. xv. 136, i.-iv.); a headless sphinx of the Miramar collection (Cat. xxix.); a small hawk inscribed on the base (F.P. Coll.); and many scarabs, cylinders, etc. One is a document of interest, giving the list of the six kings of the dynasty down to this point, in their proper order (Brocklehurst Coll.). A statue of an official of this king was in the Sabatier Coll. (Rec. xiv. 55).

Of the close of this reign the highest date is the stele at El Kab of the forty-fourth year. But a papyrus from Kahun is dated in a forty-sixth year, which can hardly be that of any king but Amenemhat III., and hence it is likely that his reign extended so far. As to whether he associated Amenemhat IV. in coregency with him we cannot be certain. Such was the principle of this dynasty, especially in long reigns like this; yet there is no certain evidence at this point. Some monuments give the two cartouches side by side as equally adored, but there is no proof that either king was alive at the time, nor that both were alive (L.D. ii. 140 m; L.A. x.). On the whole, it is not improbable that Amenemhat IV. was associated for two or three years, but no double dating of this kind is yet known.

Of the family of Amenemhat, one daughter, Ptah-neferu, appears to have died before her father, having been buried in his pyramid. Her alabaster altar and dishes remain (G. Mus.; P.K. v.); and a block of black granite with her name and titles (Rec. x. 142). The other daughter, Sebek-neferu, succeeded her brother, Amenemhat IV., on the throne.

XII. 7. MAĀ'KHERU'RA

 about
 2578-
 2569
 B.C.

AMENEMHAT IV.



Sarbut el Khadem	Tablets	(L.D. ii. 140 o, p).
Wady Maghara	Tablet	(L.D. ii. 140 n).
Kahun	Papyrus	(G.K. xxxiii.).
Shut er regal	Tablet	(P.S. 444).
Kummeh	Tablet	(L.D. ii. 152 f).
Paws of a sphinx,	quartzite	(G. Mus.).
Plaque (B. Mus.).		
Scarabs (B. Mus.,	Louvre, F.P. Coll.).	

 FIG. 113.—Scarab
 (P. Mus.).

This reign shows the declension of the dynasty. The monuments are scanty and unimportant; they all fall, however, in the fifth and sixth year, which gives some reason to suppose a coregency in the earlier part of the nine years' reign.

At Sarbut el Khadem the *ka* name and the throne name occur in isolated fragments without longer inscription (L.D. ii. 140 o, p); while at Wady Maghara a short inscription is dated in the sixth year (140 n). The paws of a sphinx in yellow quartzite also bear his name (G. Mus.). The name does not appear at all at Hawara, which is rather strange, as that of Sebekneferu occurs sometimes in the temple. At Shut er Regal is a cartouche that may be of Amenemhat IV. (P.S. 444). At Kummeh a brief tablet of the fifth year records the rise of the Nile (L.D. ii. 152 f). One papyrus of Kahun is dated in the sixth year of the reign (G.K. xxxiii.). A plaque of green glazed schist (in the B. Mus.) bears the names of Amenemhat IV., with a cartouche Ameny; this may possibly be an associated prince, though scarcely the Ameny Ra'sankh'ab, the sixth of the next dynasty. Only four scarabs are known, one in B. Mus., one in F.P. Coll., and two in the Louvre.

XII. 8. SEBEK·NEFERU

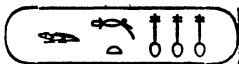

about
2569-
2565
B.C.

Khataaneh Sphinx (N.G. 9 c).

Hawara Temple (L.D. ii. 140, F.P. Coll.).

Cylinder (B. Mus.); Scarab (G. Coll.).



FIG. 114.—Scarab (G. Coll.).

Of this queen, stated by Manetho to have been the sister of Amenemhat IV., we have very slight remains. A sphinx of grey granular siliceous rock at Khataaneh has an effaced cartouche between the paws, which may be that of this queen; but the *ka* name is entirely gone, and the cartouche only shows traces of a Ra, a square sign (pedestal of the crocodile?), and three vertical lines. As no other cartouche agrees to this, it may be left to the credit of this queen.

At Hawara her name occurs as often as that of her father; as, beside the examples of Lepsius (L.D. ii. 140), a column (P.H. xxvii. 12) and a block (P.K. xi. 1) naming her have also been found there. How it is that she is associated with this temple, to the exclusion of her brother, is not clear; but the remains are so scanty that little can be argued about it.



FIG. 115.—Cylinder, blue on white (B. Mus.).

The finest small piece of the later part of the dynasty is, however, of this queen, a beautiful cylinder (Fig. 115) of white schist glazed blue, of unusual size, and bearing all her titles: "*Hor Ra'mert; double diadem Akhet kherp nebt tau; Hor nub Dad'kha; Suten bat (Sebek'shedti'neferu) ankh tha; Sebek shedti mery*" (B. Mus.).

A scarab of hers is also known (G. Coll.).

Before parting from the XIIth dynasty, one remarkable point should be noticed. The reigns are all long, and yet it is generally assumed that the kings were each sons of their predecessors. Though the time of life of association as coregent may have been very uncertain, yet on a series this vagueness is so subdivided that it does not much affect the question. Setting aside Amenemhat I., who fought his way to the throne probably late in life, the reigns of the other kings, from being coregent, to adopting a successor as coregent, are 42, 32, 26, 38 (?), 44 years; the average of the three certain ones at first is 33 years, or, including all of them, 36 years. Now, it is wholly unlikely that each of these kings had no son until they were so advanced in life. Either, then, their successors were not eldest sons, but only sons who were selected by the king as being most able, or sons of heiress-princesses; or else there have been several generations passed over, and grandsons were more usual as successors than direct sons. To reduce the average of 36 to the more likely average of 20 years, there must have been four grandsons adopted as coregents, passing over the direct sons. One clue to this peculiarity may lie in the female succession. There is some ground for supposing that the throne, like any other property, descended in the female line; and that the custom of brother and sister marriages arose from the desire that sons should inherit. If so, it is quite possible that the sons had no claim to the throne legally; but that the king had it in his choice to select the most suitable son or grandson, and by

marrying him to a particular princess in the line, he thus created him the heir to the throne.

This great period of the XIIth dynasty is marked by somewhat the same characteristics as the first age of Egyptian development. It begins with a firm organisation of the country, and a solidity and brilliancy of work that shows great and able guidance; that is succeeded by a time of tranquil internal prosperity, under the second Amenemhat and Usertesen, as before under the Vth dynasty; and then comes the tide of foreign conquest under Usertesen III. as under Pepy I. A long and splendid reign of Amenemhat III. leads to a brief time of decay; much as the long reign of Pepy II. led to the disorganisation of the VIth dynasty. And in each case an age of short reigns, confusion, and weakness succeeds this outburst of ability. It is singular how parallel the two cycles of development run, one with another; but such seems to be much the course of government in its growth and fall in all ages; and growth, prosperity, foreign wars, glory, and decay succeed each other as the seasons of the great year of human organisation.

The work of this dynasty is among the finest. It could never profess the vitality of the early times, yet it showed a technical perfection and care which is perhaps unsurpassed. The sculptures of Amenemhat I. and Usertesen I. from Koptos, the sarcophagus of Usertesen II., and the tomb chamber of Amenemhat III., are as perfect in workmanship as anything wrought by man. It is much to be hoped that further exploration may reveal to us more of this brilliant age, and that the pyramids of other kings of this dynasty may be discovered.

The private works of this time are fine and substantial; though less spontaneous, they are yet superior to the sculptures of any time since the IVth dynasty, and mark the high level of **technical and formal skill which was reached in this age.**

CHAPTER IX

THIRTEENTH AND FOURTEENTH DYNASTIES

WE now reach the second of the two great periods of obscurity in Egyptian history. The dark age of the VIIth–XIth dynasties we have filled up to some extent, thanks to Eratosthenes and the scarabs, besides having the well-known list of a portion of it in the table of Abydos, and the fragmentary but useful statements in the Turin papyrus. For the period from the XIIIth to the XVIIth dynasty the materials are even less satisfactory. There is the Turin papyrus beginning in good condition, but becoming more and more broken, until dozens of names may be placed in almost any position. There is the wildly irregular list of Thothmes III. at Karnak. And there are various excerpts and summaries of Manetho by Josephus, Africanus, Eusebius, etc. Of monuments there are only scattered remains, and no contemporary evidence as to succession.

Two views have been held regarding the only series of names that is of use—the Turin papyrus. Brugsch adopts it as a continuous list of successive names, but Lieblein considers that it is compiled from six alternating sections of the kings of the XIIIth and XIVth dynasties. For this latter hypothesis there does not seem to be any sufficient ground. There could have been no reason for alternating the portions of the dynasties unless they were contemporary; if contemporary, they would be rival lines; and in the case of

the IXth and Xth dynasties we see that rival lines are not reckoned in the Turin papyrus. We shall therefore treat the Turin papyrus as a consecutive record, so far as the terribly broken state of it permits; and no arrangement of the pieces will be here adopted for which there is not good reason in the character of the writing (which varies in different parts), the spacing of the lines, the nature of the fibres, and the style and position of the lines of later accounts scribbled on the back of it. Where all these clues fail to show the order of the fragments, we shall state that the various pieces may be arranged in almost any order.

Before entering on the details of the names and reigns, it will be well to review the whole period from the XIIIth to the XVIIth dynasties, and so to see what is the general scheme of the evidence that we have.

For this the remains of Manetho are our only guide for the duration of the period. And we will first review them briefly in their most reliable forms, the text of Josephus, and the tables of Africanus and Eusebius.

AFRICANUS.		EUSEBIUS.		JOSEPHUS.		
Dynasty.	Kings.	Years.	Dynasty.	Kings.	Years.	on Hyksos.
XIII.	60	453	XIII.	60	453	
		or 153				
XIV.	76	184	XIV.	76	484	(after confusion, at length they made a king).
XV.	6	284	XV.	π	250	Hyksos, 6 kings, 260 years.
	(Hyksos)			(Theban)		
XVI.	32	518	XVI.	5	190	(this people and their descendants in all 511 years).
	(Shepherds)			(Theban)		
XVII.	43	151	XVII.	4	103	
				(Hyksos)		

Setting aside for the present the details of the reigns of the separate Hyksos kings, such are the materials for unravelling this period.

The Turin papyrus gives in many cases the length of the reigns, and the average of eleven reigns remaining is $6\frac{1}{2}$ years each in the period of the first sixty kings, which is presumably the XIIIth dynasty. This points to about 390 years for the whole sixty kings, and agrees therefore with the 453 years far better than with the reading 153 years. In fact, deducting the 71 years of eleven kings from 153 years, there would only be left 82 years for forty-nine kings, which would be certainly unlikely. We may then adopt the reading 453 years as far the more probable.

The next question is, were the Hyksos contemporary with the XIIIth and XIVth dynasties? So far as the XIIIth, the distribution of the monuments of the first sixty kings of the Turin papyrus seems to show that they held all Egypt. The fifteenth king is found at Semneh and at Bubastis, the twenty-third at Tanis and in Ethiopia, and the fifty-third is Ra'nehesi, who is believed to be related to the king's son Nehesi found at Tanis, and the king Nehesi found at Tell Mokdam. We cannot then suppose the Hyksos to have been contemporary with the 453 years of the XIIIth dynasty. Probably the limit of the XIIIth dynasty is at the mark of a new section beginning at No. 56 in T.P., as two or three kings may have been omitted in this numbering.

The whole Hyksos period is stated at 511 years by Manetho, according to Josephus, and is divided into three stages. First, "they had our rulers in their hands . . . and inflicted every barbarity." Next, "At length they made one of themselves king," and the six reigns occupying 260 years are specified. Then "these six were the first rulers amongst them," and the "shepherd kings and their descendants retained possession of Egypt 511 years." Here there is first a period of harrying and plundering the native rulers; second, a fixed Hyksos rule, well organised and long-lived; third, the rule of their descendants, extending altogether to a dominion of 511 years. This total

period is terminated by the expulsion of the Hyksos, and the establishment of the XVIIIth dynasty.

Now, the essential difference between the summaries of Africanus and Eusebius is, that the latter puts the Hyksos at the end of the dark period; while Africanus inserts them between the XIVth and XVIIth dynasties. As the account of Eusebius does not agree with Josephus, while that of Africanus agrees in the number of Hyksos kings and their reigns, it appears that Africanus is the better guide. His XVIth dynasty is, however, evidently the summary of the whole Hyksos period, 518 years, according with the 511 of Josephus; and therefore including the 284 years stated before it, and the 151 years stated after it. The XVIIth dynasty of Africanus seems to be corrupt as to the number of kings, stated as 'forty-three shepherd kings and forty-three Thebans, who reigned together 151 years. The equality of the numbers shows some corruption, and the reigns are very short.

Some clue in this confusion may be reached by seeing what dynasties will agree to the total Hyksos period. The last 151 years of the Hyksos appears to have been a joint rule of Hyksos suzerains and Egyptian vassals, as shown in the tale of Apepa and Seqenenra. There will therefore be 260 years of the great Hyksos kings, and 151 years of their descendants, making 411 years of their kings altogether. This would leave a round hundred years, out of the total of 511, for the confused period of their harrying of the Egyptians; as that was probably an indefinite period, of a gradual increase of power, it is very likely to have been put roundly at one century, which, added to the reigns of 411, made 511 years' total, or 518 years, according to Africanus.

How, then, does this stand in relation to Egyptian reigns? The 151 years at the end is a joint rule during the XVIIth dynasty. But what went on during the six great Hyksos kings and the confusion before them? Africanus gives no material here; but it seems not unlikely that the XVIth Theban dynasty of Eusebius

refers to this age, five kings reigning 190 years, as we see that his XVth dynasty is apparently intended for the XVth dynasty of the six great Hyksos. This 190 years occurs in the old Egyptian chronicle in Syncellus as of eight kings, which is rather a more likely number. This, then, is the material which, on the Egyptian side, makes up the period of Hyksos rule.

About B.C.	EGYPTIANS.		HYKSOS.		About B.C.
2565	XIII. 60 kings, 453 years.				
2112	XIV. 76 kings, 184			years.	2098
1928	XVI. 8 kings, 190	} 525		confusion 100	1998
1738	XVII. α kings, 151			XV. 6 kings, 260	1738
1587				XVII. α Kings, 151	511

Such seems, from this very confused material, to be the most likely original statement. If this be so, Africanus has formed his digest thus—

His XIIIth is the Egyptian XIIIth.
 " XIV " Egyptian XIV.
 " XV " Hyksos XV.
 " XVI " Hyksos total.
 " XVII " joint XVII.

Eusebius, on the other hand, has compiled thus—

His XIIIth is the Egyptian XIIIth.
 " XIV " Egyptian XIV.
 " XV " Hyksos XV. (called Theban, as they ruled over Thebes).
 " XVI " Egyptian XVI.
 " XVII " joint XVII.

Josephus has neglected the Egyptians altogether, and given only the Hyksos material, according to his object. The practical equivalence of the 511 years of the Hyksos, the 518 years in Africanus, and the 525 years of the three Egyptian dynasties, is our best clue through this

tangle; and the small differences between these accounts may readily be accounted for by the count of 100 years in round numbers for the confusion beginning the Hyksos domination, and by some one king being reckoned as independent at the beginning of the XIVth or end of the XVIIth dynasty.

If we accept the above settlement, we may divide the periods thus in detail—

XIII.—60 kings,	453 years		
XIV.—76 kings	{ 14 years before Hyksos	} 260	} 511
	{ 100 years harried by the Hyksos		
	{ 70 years under the great Hyksos		
XVI.— 8 kings,	190 years	" " "	} yrs.
XVII.— x kings,	151 years' struggles with Hyksos		

This arrangement is corroborated by a fragment of the Turin papyrus, which has been certainly misplaced hitherto; it is numbered 32, but cannot belong to the IVth dynasty (where it has been placed), both by the lengths of the reigns, and by the part of a name*sefa*. Nor can it be placed at any other part of the papyrus until we reach the end of the XIVth dynasty. Here are met a few other fragments which agree with it in the spacing, the writing, and the plain back (122, 133, 135). And in the XIVth dynasty before it are at least three kings ending in*sefa*, so that the type of name was not then uncommon. The lengths of reigns also accord better with this age of the XVIth dynasty than with any other unsettled period. The numbers are 6, 6, 24, 24, 21, 8 years. The 6 year reigns might be the end of the XIVth dynasty; and if four reigns occupy 77 years, that would leave 113 years for the remaining four reigns in the XVIth dynasty; not at all an unlikely number, when we have two of 24 years already here before us.

Until, then, some further material may come to light, it does not seem that we can do better than accept provisionally the arrangement which we have here outlined. And on this basis we shall now proceed to deal with the details of this period.

XIIIth dynasty, about 2565-2112 B.C.

According to the Turin papyrus.

"Mon." refers to account of monuments, following this.

	YEARS.		YEARS
1		Ra'khu'tau	25
2		Ra'sekhem'ka . Mon. 6	{ Ra'uah'ab . . . Mon.
3		Ra'amen'em'hat	{ Aa'ab . . . 10y. 8m. 28d
4		Ra's'hotep'ab	{ Ra'mer'nefer . . . Mon.
5		Aufni	{ (Ay) . . . 23y. 8m. 18d
6		{ Ra's'ankh'ab . . . Mon.	27 Ra'mer'hotep Mon. 2y. 2m. 9d
		{ (Ameny Antef Amenemhat)	28 { Ra'sankh'n
7		Ra's'men'ka	{ Set hetu? . . . 3y. 2m.
8		Ra's'hotep'ab . . . Mon.	29 { Ra'mer'sekhem? . . . 3y. 1m.
9	ka	{ An'ren
10		Ra'nezem'ab	30 { Ra'suaz'ka . . . 1 + 'y
11		Ra'sebek(hote)p . . . Mon.	{ Hora
12		Ren'senb	31m..... . . . 2 + 'y.
13		Ra'fu'ab . . . Mon.	32 to 35 lost.
14		Ra'sezef (a'ab)	36 Ra'mer'kheper
15		{ Ra'sekhem'khu'tau	37 {(Ra)'mer? ka . . . Mon.
		{ Sebek'hotep (I.) . . . Mon.	{ (Sebek'hotep VI. ?)
16		Ra'user.....ra	38ka
17		{ Ra(smenkh)ka . . . Mon.	39 Lost.
		{ Mer'meshau	40mes
18		{ka	41 { Ra...maat . . . Mon.
		{ Anu	{ Aba . . .
19		..user'ur..	42 { Ra...uben
20		{ Ra(sekhem'suaz'tau)	{ Hora?
		{ Sebek'hotep (II.) . . . Mon. 3	43ka
21		{ Ra'kha'(seshes) . . . Mon. 11	44 Ra...maa
		{ Nefer'hotep	45 Ra
22		Ra'hat'heru'sa	46
23		{ Ra'kha'nefer . . . Mon.	47 Ha.....
		{ Sebek'hotep (III.)	48 Sa
		[Brugsch supposes two lost	49 Hapu
		here, namely	50 Shemsu
		Ra'kha'ka	51 Mena....
		{ Ra'kha'ankh	52 Ur....
		{ Sebek'hotep (IV. ?)	53 Ra'nehesi . . . Mon. ?
24		{ Ra'kha'hotep . . . Mon.	54 Ra'kha'thi
		{ Sebekhotep (V. ?) 4y. 8m. 29d.	55 ...neb'fu . . . 1y. 5m. 15d.

Fragments,
41 and 89.

A fresh heading begins at the next entry; and as the above section contains nearly the number of kings (fifty-

five or fifty-seven) in Manetho's XIIIth dynasty, it is probable that at this point is the end of this dynasty. The names that follow in the papyrus have a new type, three of them ending in ...zefa, which has not occurred in the foregoing part.

We shall now refer only to those kings of whom some remains are known; leaving, with the above mention, those who are only recorded in the Turin papyrus.

XIII. 2. SEKHEM·KA·RA



about
2560 B.C.

A stele naming this king was found, probably at Benha, and subsequently copied by Brugsch at Alexandria (B.T. 1455); its place is now unknown. It is a tablet of a noble, a king's son, named Mery·ra (perhaps the same of whom a scarab remains, P.I. viii. 40). On the upper part a Nile figure kneels, offering vases bearing *ankh·ded·uas* to the hawk on the *ka* name, *S'ankh·tau*: the cartouche of Sekhem·ka·ra comes next to this. His third year is named on a papyrus from Kahun (G.K. ix.).

XIII. 6. SANKH·AB·RA

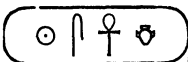

about 2520
B.C.

AMENY·ANTEF·AMEN·EM·HAT



Of this king a noble table of offerings was found at Karnak. It consists of two square blocks of quartzite, carved with twenty small cup hollows in rows on the top, and bearing the various titles and names of the king around the sides (G. Mus.; M.K. ix.-x.).

XIII. 8. RA·SEHOTEP·AB

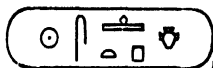

about
2510
B.C.

Some scarabs bearing this name (P. Mus.; F.P. Coll.) are so rude in workmanship that they cannot be assigned to the reign of Amenemhat I., in which fine work prevailed.



FIG. 116.—Cowroids
(F.P. Coll.)

XIII. 11. RA SEBEK·HOTEP

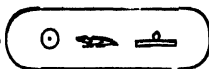

about
2490
B.C.

Two scarabs of this king are known (F.P. and H. Colls.).



FIG. 117.—Scarabs (F.P. and H. Colls.).

XIII. 13. RA·FU·AB

The pyramid of this king has been identified this year with the south brick pyramid of Dahshur. In this was found the coffin and an ebony statue of this king. Near this pyramid was the tomb of a princess, Nub·hetep·ta·khrudet, found intact with all the furniture. Particulars have not yet been published.

XIII. 15. RA·SEKHEM·KHU·TAUI

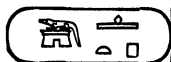

SEBEK·HOTEP I.

about
2460 B.C.

Bubastis, lintels (N.B. xxxiii. G.I.).

Kahun, papyrus (G.K. x.).

Semneh, Nile records (L.D. ii. 151 a-d).

Cylinders (B. Mus.; E. Coll.).

FIG. 118.—Cylinder
(B. Mus.).

This king appears as a builder at Bubastis, two lintel blocks bearing his name. At Kahun a papyrus was found dated in his third year. The records of the high Nile at Semneh are of each year to the fourth. And some cylinders bear his throne name; while many scarabs inscribed only Sebekhotep are probably of his age.

XIII. 17. RA·SMENKH·KA

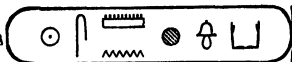

MER·MESHOU

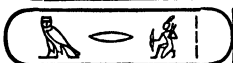
about
2450
B.C.

Two large statues of grey syenite at Tanis bear these names (P.T. I. iii. 16). They are finely and massively executed, and differ much in style from the slender and shallow work in red granite of Sebekhotep III.; but this difference of style is easily due to the different local schools of art at different quarries. The statues were afterwards appropriated by Apepa, who carved his name on the arm (P.T. I. xiii. 6). There is some doubt as to the position of the king represented by these statues. In the Turin papyrus this No. 17 has only *ka* left at the end of the cartouche, and

following it *mer-mesha*, as the personal name or title. As that, however, was a common military title, and also the title of the high priest of Mendes, there might be more than one king so called. On the other hand, a later king, No. 79, is named *Ra'smen* . . . ; but he is not so likely to have erected statues, as by that time the Hyksos were in the land, and it is rather in the first fifty-five names that this must be sought, though it might be any one of ten missing names in this period.

FIG. 119.—Grey syenite statue of Mermeshau, Tanis.

On the whole, it is probable that the seventeenth king is the one represented. Whether he were a general or the high priest has been debated ; but as on the statues he is said to be loved of Ptah, and not of the Mendesian Ba'neb'dad, he is more likely to have been a general.

XIII. 20.
RA·SEKHEM'SUAZ·TAUI



SEBEK·HOTEP II.

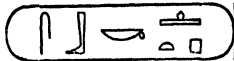

about 2420 B.C.



FIG. 120.—
Scarab
(G. Mus.).

This king is known on monuments with these two names ; but of the first cartouche only the Ra is certain

in the Turin papyrus, and the rest is blotted and broken. As, however, there is no other Sebekhotep without a fixed place in the papyrus, it is probable that this position No. 20 belongs to this king. His principal monument is a stele bearing his names in the Louvre (Pr. M. viii.) (Fig. 121); the scene represents two deceased daughters of a king adoring Min. They are Auhet·abu and Anqet·dudu, born of the queen Nen·na. What relation they were to the king Sebekhotep II. is not stated. They can hardly have been his sisters, as his mother is stated on the scarabs to have been Auhet·abu, and not Nen·na. But they might have been his daughters or aunts. It has been supposed that this deceased Auhet·abu is the same as his mother, but in that case she would certainly have been given the higher title of royal mother, and not only royal daughter.

More is recorded of the family on scarabs, and on a tablet at Vienna (Rec. vii. 188). From these we learn that the parents of Sebekhotep II. were the divine father Mentuhotep (P. Mus.; G. Mus.), and the royal mother Auhet·abu (G. Mus.; M. Coll.). The tablet is of a prince Senb, whose parents were likewise

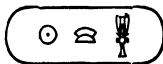

FIG. 121.—Stele of Sebekhotep II.
Royal daughters adoring Min.

Mentuhotep and the king's mother Auhet'abu, pretty certainly the same persons. Further, the children of Senb are stated as Sebekhotep, Auhet'abu, Hent, and Mentuhotep.

This king is mentioned in the tomb of Sebek'nekht at El Kab, as having given lands to the temple at that place (L.D. iii. 13 b).

XIII. 21. RA·KHA·SESHES



about
2410 B.C.

NEFER·HOTEP

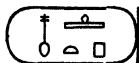

Abydos
Karnak
Shut er Rega
Aswan
Sehel

Stele
Cartouche
Inscription
Family tablet
Steles

(M.A. ii. 28-30).
(M.K. viii. o).
(P.S. 479).
(P.S. 337).
(L.D. ii. 151 g ;
M.D. lxx. 3).
(L.D. ii. 151 f, h).

Konosso
Statue
Scarabs

Steles
Bologna Mus.



FIG. 122.—Scarab
(F.P. Coll.).

The large stele of this king found at Abydos records his sending to repair the temple there according to the directions of the sacred books, and to learn the will of the god ; for when he had unrolled and read the writings, he desired to honour the god according to all that he had seen in the books. There is some reason to suspect from the style of this stele that it may not be really of this age ; and the matter of it is so likely to have served to excite the liberality of some later king, that we may pause before fully accepting it. One small point is of value, that the king sends a messenger southward to Abydos, which suggests that

the XIIIth dynasty did not live at Thebes. It is possible, as Sebek was constantly adored by them, and the statue of Neferhotep calls him beloved of Sebek in the midst of Shed (or Crocodilopolis), that the seat of government was really in the Fayum; having remained there since the close of the XIIth dynasty, the remains of which time are mainly in that province. A smaller stele found at Abydos shows Neferhotep before the god Min (M.A. 768).

A block at Karnak, which bears the cartouches of both Neferhotep and Sebekhotep III. (M.K. viii. n, o) shows that very probably they were coregents. We know from the scarabs that the

father of each of these kings bore

the same name, Ha'ankh'f, and the mother of a Sebekhotep was Kema, like the mother of Neferhotep. Hence we can hardly doubt that they were brothers. But two rock inscriptions at Aswan (P.S. 337) and Sehel (M.D. lxx. 3) record more of the family. From these we gather that Ha'ankh'f and Kema were the parents of Neferhotep; that Senbsen was his wife, and that there were four royal children, Hat'hor'sa, Sebekhotep, Ha'ankh'f, and Kema. The repetition of family names leaves the relationships dubious. We can only state them thus—



Fig. 123.—Statuette of Neferhotep.

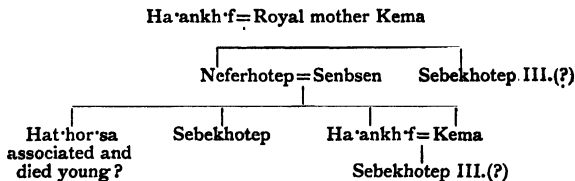

leaving yet unsettled the question of whether Sebekhotep III. was brother or grandson of Neferhotep.

At Shut er Regal, near Silsileh, is a cartouche of

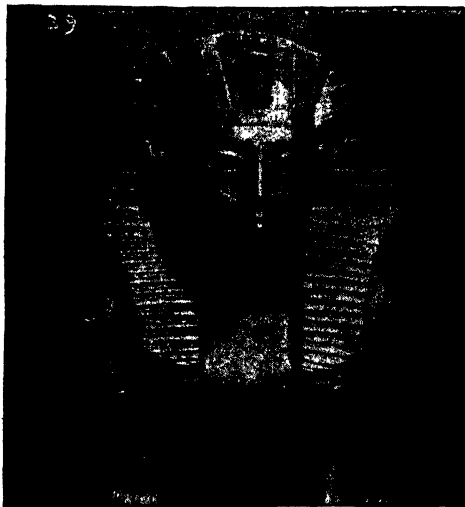

FIG. 124.—Black basalt statuette of Neferhotep (Bologna Mus.).

Neferhotep; and at Sehel and Konosso, at the First Cataract, are other steles which only show Neferhotep with Anqet, Min, and Sati.

An excellent work of this reign is the seated statuette of black basalt in the Bologna Museum (Figs. 123, 124). It has the old traditions of Egyptian statuary, but with a certain weakness and youthfulness of expression which is different from any earlier works. In this it shows kinship to the large statues of the other brother, Sebekhotep III.

The scarabs of Neferhotep confirm the parentage reported by the tablet at Aswan, but are not of further interest.

XIII. 23. RA·KHA·NEFER

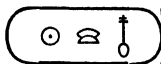

about
2400
B.C.

SEBEKHOTEP (III.)

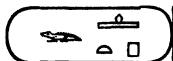

Tanis, statue (P.T. I. iii. 16).
Karnak, cartouche (M.K. viii. n).
Gebelen, sphinx (G. Mus.).
Arqo, Nubia, statue (L.D. i. 120; ii. 151 i).
Statues, Louvre.
Scarabs.



FIG. 125.—Scarab
(F.P. Coll).

The remains of this king are more widespread than those of any other reign in this dynasty. A fine statue in brown-red granite lies at Tanis (Fig. 126) (P.T. I. iii. 16); and a fellow-statuette of double life size in the Louvre, of uncertain source, probably came from the same place. There is also a statue almost life size in black granite (P. Mus.). These statues are finely and gracefully wrought, but without the vigour of earlier work, or even of the Mer-meshau statue carved shortly before them; and as they have never been usurped by any king, they have not been brought

at a later date from elsewhere. A small sphinx of black granite was found at Gebelen (G. Mus.).

The cartouche occurs at Karnak (M.K. viii. n) with that of Neferhotep, as we have noticed before. And there was found also an adoration to this king from a *mer'meshau* named Amenemhat (M.K. viii. p).

But the most astonishing remains of this dynasty are



FIG. 126.—Red granite statue of Sebekhotep III., Tanis.



FIG. 127.—Grey granite colossus of Sebekhotep III., Island of Arqo.

the statues lying on the island of Arqo above the Third Cataract (see Hoskins' Ethiopia, p. 213). These are two colossi of grey granite, 23 feet high, lying upon their backs, one of them yet whole (Fig. 127). One is inscribed with the full names and titles of this king (L.D. i. 120; ii. 51 i). A remarkable point of decoration is a wreath around the top of the crown of Lower Egypt on one statue; such is unknown on any other Egyptian figure. These figures cannot have been brought up the cataracts, and must therefore

have been cut in Upper Nubia, probably in a quarry at Tombos. They formed part of a temple there, of which some figures of baboons yet remain, together with a seated statue of Sebekhotep with inscriptions. There is then the proof that as late as the middle of the XIIIth dynasty the Egyptians held the country far above Semneh, which had been the frontier of the XIIth dynasty. With power thus widely extended, we see no sign of foreign invasion, nor of internal weakness. Why it is that there are so few remains of this dynasty must rather be attributed to the lack of taste for building than to the lack of power.

The scarabs of Sebekhotep III. are common, and usually combine both of his names.

RA·KHA·KA

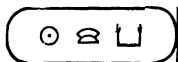

about 2390 B.C.

In the table of Karnak, amid the originally confused and now fragmentary sequences of that record, there occur in successive order Ra·sankh·ab, Ra·sekhem·khu·taui, Ra·sekhem·suaz·taui?; Ra·kha·seshes, and Ra·kha·nefer, or the 6th, 15th, 20th, 21st, and 22nd kings of the Turin papyrus; then comes a lost piece which is restored by Lepsius as Ra·kha·ka, though as that part was missing even when Burton made his copy early in this century, it is difficult to know on what ground Lepsius—or L'Hôte, from whom he copied—ventured on this restoration. Coming to the next line, we see Ra·kha·ankh, Ra·kha·(hotep?), and then three kings which cannot be identified in this part of the Turin list, before reaching Ra·mer·kau, the 37th king of Turin. This discrepancy shows that we cannot assign much weight, even in a favourable passage, to the sequence in the Karnak list. However, on the strength of that list, Brugsch has inserted two kings, Ra·kha·ka and Ra·kha·ankh (Sebekhotep) at the foot of the broken column of the Turin papyrus, ending now at No. 23, before the next column begins at No. 24.

The best ground for this is the difficulty of finding any other place for Ra·kha·ankh among the known names of the Turin papyrus; but as at least half a dozen names are wholly lost out of the XIIIth dynasty, that matter might easily have another resolution. All we can say is that this king belongs to some position before the decadence of the dynasty, and that the Karnak list suggests the place for him, and also for a king Ra·kha·ka, if the restoration of Lepsius has any authority.

Of Ra·kha·ka there is one scarab (F.P. Coll.), which can hardly be attributed to the other king of that name in the preceding dynasty, as it is coarsely made of pottery.



FIG. 128.—Scarab (F.P. Coll.).

RA·KHA·ANKH

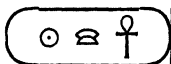

about
2390
B.C.

SEBEK·HOTEP (IV?)

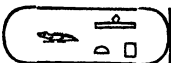

FIG. 129.—Scarab (G. Coll.).

Koptos, part of stele.

Stele, Leyden.

Slabs from temple (P. Mus.; B 4, 5; C 9, 10).

Scarab (G. Coll.).

Queen? Nub·em·hat.

Daughter? Sebek·em·heb.

At Koptos a fragment of a private stele names the king's daughter Sebek·em·heb, whose mother (?) was the great royal wife Nub·em·hat, and mentions the *Hor sam tau*, apparently Sebekhotep IV. still living; the inscription is for Per·nub, who seems to have been the daughter of the son of a royal courtier Amena, who was son of a queen Ha·ankh's. This would put Ha·ankh's about two or three generations before

Sebekhotep IV., and thus she might be of the same age as Ha'ankh'f, the father of Sebekhotep III.

Four slabs sawn from the building of some temple are in the Louvre, on which the king is shown offering to Min and Ptah. A stele is also in Leyden, and one rude scarab is known (G. Coll.).

XIII. 24. RA'KHA'HOTEP

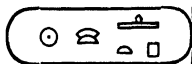

about
2380-
2375
B.C.

SEBEK'HOTEP (V?).

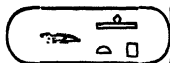

Of this king only two scarabs are known ; they are of the same type, with throne name and personal name, thus proving the cartouches to be of one king (P. Mus.; G. Mus.).



FIG. 130.—Scarab
(G. Mus.).

XIII. 25. RA'UAH'AB

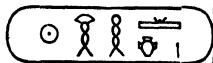

about
2375-
2364
B.C.

AA'AB

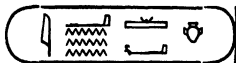

A cylinder of this king, naming him "beloved of Sebek, lord of Su'uaz" (G. Coll.), and a scarab (F.P. Coll.) are known. Also a piece of blue glazed cup from Kahun with the beginning of a royal name Ra'uah is probably of this reign (P.K. x. 72).



FIG. 131.—Scarab
(F. P. Coll.).

XIII. 26.
RA·MER·NEFER

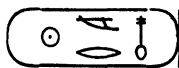

about
2364-
2341
B.C.

AY



FIG. 132.—Scarab
(G. Mus.).

Here again scarabs are the only memorial. A few bear the throne name, and one (in G. Mus.) has both names.

XIII. 27.
RA·MER·HOTEP

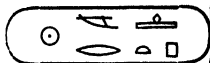

about
2341-
2339
B.C.

ANA

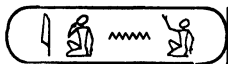
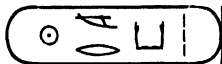

FIG. 133.—Scarab
(P. Mus.).

One scarab in the Louvre is the only contemporary object bearing the names of this king.

XIII. 37. RA·MER?KAU



about
2290
B.C.

SEBEKHOTEP (VI. ?).

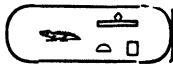

Of this king there is only a seated porphyry statue at Karnak, and no other remains (M. K. viii. 6).

XIII. 41.
RA·NEB·MAAT
about 2260 B.C.

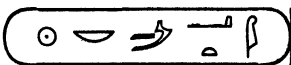

ABA



FIG. 134.—Scarab
(P. Mus.).

One scarab may be attributed to this period by the style of it, and there is no other name but the broken Ra . . . maât in the Turin list to which it can be referred.

XIII. 47-52. This fragment (No. 41) of the Turin papyrus has hitherto been unplaced, or rather hopelessly misplaced in the VIth dynasty. There is no position possible for it until we reach this point, which the style of the writing on the back would indicate. A fragment placed in this column by the restorers (No. 89) would fit No. 41 well in the spacing of lines on both sides, and their relative positions. The names on this are of a peculiar type; they are simple personal names, but revert to the most high-flown origin, recalling the god Hapi, the Shemsu-hor, king Mena, and "the great" somebody. In the names shortly before this we see the same brief style, Aba and Hora: so that we might regard these as the last efforts to retain some dignity in an expiring dynasty, who had not even the heart to adopt the Ra names and full royal title; somewhat like the Roman Empire closing with a Julius and a Romulus before its extinction in the barbarian flood.

XIII. 53. Nehesi, the successor of these kings, appears to have been a negro; either a conqueror from the south, which is hardly likely, as his remains are in the extreme north; or more probably a Sudani slave or soldier raised into power, as the only hope of an expiring rule. In the list of Turin we read No. 53 as Ra·nehesi. On the statue from Tell Mokdam near Bubastis M. Naville has read the name of the king as Nehesi, or "the negro" (N.A. iv. 28). On a piece of an obelisk at Tanis (P.T. I. iii. 19) "the king's eldest son Nehesi" is twice named, as erecting monuments to Set. And a scarab remains of "the king's son Nehesi" (Brent Coll.) (Fig. 135)



FIG. 135.—Scarab
(Brent Coll.)

Before entering on the XIVth dynasty, we must notice some kings whose names remain on monuments, but whose historical position is doubtful. Some of these kings were apparently powerful, and have left respectable remains; and the question is whether they belong to the gaps in the XIIIth dynasty, and are lost from the Turin papyrus, or whether they were among the long-reigned kings of the XVIth dynasty. The connection of name with that of Rahotep, who is again connected by his titles with the early XVIIIth dynasty, seems to point to all these belonging to the lost XVIth Egyptian dynasty under the great Hyksos kings.

In the XIIIth dynasty, however, there are seventeen kings out of forty-six known names to whom some remains can be assigned, or about one monumental king in three names; and about nine or ten names are almost entirely lost, which might therefore well include three or four monumental kings. Hence there is fairly room in the gaps of the Turin papyrus of the XIIIth dynasty for most of the following names, which are here ranked in order of their importance.

RA·SEKHEM·UAZ·KHAU



SEBEK·EM·SA·F (I.)



A standing statue of red granite three-quarters life size was found at Abydos (G. Mus.), with the names of this king (M.A. ii. 26); and a relief sculptured on the block by the legs, shows his son Sebekemsaf as deceased, which proves that this was not the son known as Sebekemsaf II. Another and smaller seated

figure of the king in black basalt, was probably found at Thebes (Fig. 136); it is headless, but bears the king's names down the front of the throne. The work is cold and formal, and the signs rudely marked (F.P. Coll.; P.S. xxi. 2).

Two steles in the Wady Hammamat show the king adoring Min, and bear both of his cartouches (L.D. ii. 151, k, 1). And at Shut er Regal the cartouche also occurs (P.S. 385). Some objects from the royal tomb have come to light, through Arab hands; a heart scarab (B. Mus.), a box (Leyden Mus.), and a gold plated scarab with the personal name, probably of this king (H. Coll.).



FIG. 136.—Basalt statuette of Sebekemsaf. Thebes (F.P. Coll.).

RA·SEKHEM·S·SHEDI·TAUI



SEBEK·EM·SAUF (II.)



This king is only known from the Abbott and Amherst papyri, which record the official inquiry concerning the royal tombs in the XXth dynasty. In the Abbott papyrus we read: "It was found that the

thieves had violated the tomb by undermining the chamber of the ground level of the pyramid, from the great exterior chamber of the sepulchre of the overseer of the granaries, Neb-Amen, of the king Men·kheper·ra. The place of sepulture of the king was found to be void of its occupant ; so was the place of sepulture of the principal royal spouse, Nub·kha's, his royal wife ; the thieves had laid hands on them" (R.P. xii. 106). The Amherst papyrus gives the confession which was afterwards extracted from one of the thieves. He states that they broke into the passage, and found the tomb "protected and surrounded by masonry and covered with roofing ; we destroyed it completely, and found them (the king and queen) reposing. We opened their sarcophagi and their coffins in which they were. We found the august mummy of the king with his divine axe beside him, and many amulets and ornaments of gold about his neck. His head was overlaid above with gold, and the august body of the king was wholly covered with gold ; his coffins were burnished with gold and silver, within and without, and inlaid with all kinds of stones. We took the gold which we found on the august mummy of the god, and the amulets and ornaments that were about his neck and the coffins in which he lay. Having also found the royal wife, we likewise took all that which we found with her ; and we set fire to their coffins, and stole their furniture which we found with them, vases of gold, of silver, and of bronze, and divided them. We parted the gold which we found with the god, in their august mummies, the amulets, the ornaments, and the coffins, into eight lots" (C.E. ii. 9-12). We have here the example of what has gone on in all ages in the tombs of the kings and great men of Egypt. From the Abbott papyrus we learn that Nub·kha's was the queen of Sebek·em·sauf, and can date a stele in the Louvre which is dedicated in the name of the "great heiress, the greatly favoured, the ruler of all women, the great royal wife, united to the crown, Nub·kha's" (P.R.

ii. 5). This stele gives an interesting family genealogy of the queen. She was daughter of the chief of the judges, Sebekdudu; and he appears to have had four wives. The more important part of the family stands thus—

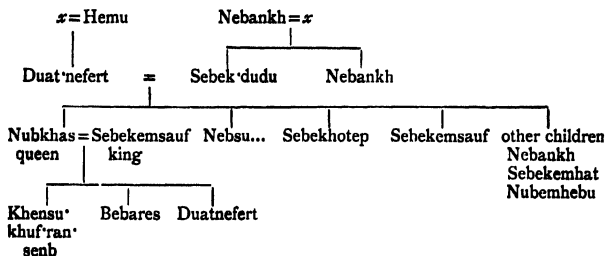

By a wife, Hemtsuten, Sebekdudu had Theti'antef.

By a wife, Dudut, Sebekdudu had Mentunesu and Hapiu.

By a wife, Senankh, Sebekdudu had Sebekhotep, who appears to have married his half-sister Hapiu, and had two children, Ada and Senankh, the latter of whom had a daughter Hapiu.

From the name of Sebek, and the use of *Shedi* by the second Sebekemsauf, it seems that these kings had their seat in the Fayum.

RA·SEKHEM·NEFER·KHAU

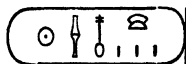

UP·UAT·EM·SAF

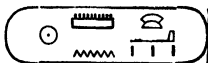

FIG. 137.—Scarab
(H. Coll.)

This king is found on a stele formerly belonging to Harris (B. Mus.). And a scarab (H. Coll.) seems to

bear the same name, with the addition of *Khe·ka*, which may be part of a *ka* name combined with it.

RA·MEN·KHAU



SNAA·AB

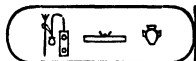

On a tablet found at Abydos (G. Mus.), this king is represented adoring Min (M.A. 771 ; ii. 27 b), but there is nothing to throw light on the age or connection of it. The style, however, is ruder than that of the other monuments of this dynasty.

RA·EN·MAĀ·EN·KHA

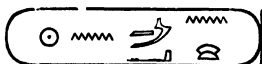

KHEN·ZER

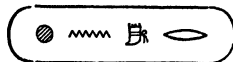

A stele bearing these two cartouches of one king is in the Louvre, recording the repairs of the temple of Usertesen I. at Abydos by Ameny-senb (C.E. iii. 2, 203 ; L.A. x.) (Fig. 138).

These five kings comprise all the unplaced ones that are likely to belong to the XIIIth dynasty.

The positions of these kings may well be either between Nos. 23 and 24, or in 31 to 35 of the Turin papyrus, but more cannot be said ; three of these ending in *Khau* suggests that they belong together, and links them with Rahotep.

The name read Ra·sekhem·up·taui is probably

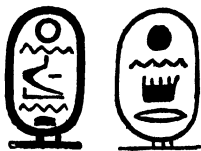

FIG. 138.—Cartouches of Khen'zer (P. Mus.).

Sebekhotep I. misread ; Ra'nefer'kheper'ka is Tahutmes I. misread ; Ra'en'mut'er'ka is doubtful, and may be Ra'en'zer'ka.

XIVth Dynasty, about 2112-1928 B.C.

According to the Turin papyrus.

The numbering is consecutive with that of the XIIIth dynasty.

	YEARS.		YEARS.
56	Ra'sheh . . . 3	82	to 86 (lost)
57	Ra'mer'zefau . . 3+	87	Ra'snefer.... . Mon.
58	Ra'senb'ka . . . 1	88	Ra'men....
59	Ra'ra'neb'zefau . 1	89	...uah....
60	Ra'uben . . . 4 ?	90	(lost)
61	(lost)		_____
	(After this point the various fragments may be arranged in many ways, and have unknown spaces between them.)	91	(lost)
		92	(lost)
		93	?
		94	A....
		95	A....

62zefa . . . 4	96 ka
63uben	97	(lost)
64ut'ab	98 Hapu
65	Ra'her'ab	99 ka Nenu
66	Ra'neb'sen	100ka Bebnm....
	_____	101	(lost)
67	(lost)		_____
68	Ra...	102	Ra.....
69	Ra'skheper'en	103	Ra'ha....
70	Ra'dad'kheru	104	Ra'ha....
71	Ra'sankh....	105	Ra'ses....
72	Ra'nefertum...	106	Ra'neb'ati'au
73	Ra'sekhem....	107	Ra'neb'ati'au
74	Ra'ka.....ab ?	108	Ra'smen....
75	Ra'nefer'ab . Mon.	109	Ra'se'user . 12
76	Ra'a.....	110	Ra'ha'shed....
77	Ra'kha....		_____
78	Ra'ankh'ka.... . 5	111	Ra'ha....
79	Ra'smen.....	112	(lost)
80	(lost)		_____
		113	114 (lost)

	YEARS.		YEARS.
115	R'a.....	130	to 132 (lost)
116	(lost)	133	(lost)
	(Summation)	134	(lost) 6
117	Ra'user.....	135zefa' 6
118	Ra'user.....	136	(lost) 24
		137	(lost) 24
119	120 (lost)	138	(lost) 21
		139	(lost) 8
121	A..f.....	140	to 142 (lost)
122	Set.....		(This last piece (frag. 32)
123	Sunu.....		has been formerly mis-
124	Hor.....		placed in the IVth
			dynasty; but there is
125	An'ab		no place possible for it
126	Ra.....s		until we reach the long
127	Penens..n sept		reigns of the XVIth
128	Pedu nebti		dynasty; it appears to
			join with fragments 122,
129heb'ra		133, and 135.)
	(Summation ?)		

In these fragments is seen the same breakdown of the Ra names toward the close, and a reversion to private names alone, which we noticed before on a piece which is probably of the close of the previous dynasty. The fragments with names, 91 to 95 and 121-124, have been attributed to the Hyksos, apparently on the ground of the names beginning with Set.... and A.... (like Staan and Apepi); but as the other entries do not agree to the known Hyksos names, it seems probable that they may belong to the XIVth dynasty, when that was contemporary with Hyksos kings, and followed the style of their names.

We have already discussed the arrangement of the dynasties of this age, and will just recapitulate the order at which we arrived.

	EGYPTIANS.	HYKSOS.
IV.	76 kings 14 years before Hyksos? 100 years harried by Hyksos 70 years under great Hyksos }	100 years' confusion 260 years. Great Hyksos kings.
VI.	8 kings 190 years under great Hyksos }	
VII.	x kings 151 years struggles with Hyksos }	151 years kings.

From this we gather that the average reigns of the XIVth dynasty were but two and a half years each ; and the average of the thirteen reigns, assigned and unassigned, that remain in this latter part of the Turin papyrus is under three years, or, excepting one unusually long reign, it is two years. So the accordance of the average is very close, and gives us some confidence in Manetho's numbers of both years and kings. The total number of kings after the XIIIth is at least 85, and was probably about 110, in the Turin papyrus. This would accord to the $76 + 8 = 84$ kings of the XIVth and XVIth dynasties, with perhaps the other kings of the XVIIth dynasty.

Of only two kings of the XIVth dynasty can any remains be identified, namely, 75 Ra'nefer'ab. This cartouche is reported to have been copied on a stone in the mosque at Beni Ali (near Manfalut?) by Gliddon (MS. note by Dr. Birch) ; the *ka* name, though incompletely copied (*..u'tau*), is enough to show that this is not the name of Psamthek II. One scarab bears this name (T. Mus.) (Fig. 139).



FIG. 139.—Scarab (T. Mus.).

87 Ra'senefer. This may be the same king as on a scarab bearing Ra'senefer at Berlin.

Of other kings who belong to this period, some are known from the table of Karnak, which gives the kings of this age in the following order—

.....ka	Turin list,	2 ?
Ra'suaz'en	"	...
Ra'sankh'ab	"	6
Ra'sekhem'khu'tau	"	15
Ra'sekhem'suaz'tau ?	"	20
Ra'kha'seshes	"	21
Ra'kha'nefer	"	23
Ra'kha'ka ? ?	"	23 a ?
Ra'kha'ankh	"	23 b ?
Ra'kha (hotep ?)	"	24
Ra'snefer...	"	87 ?
Ra.....	"	...
Ra'ses'user'tau	"	..
Ra'mer'kau	"	37

Ra'mer'sekhem	Turin list,	29
(Lost)	"	...
Ra'sekhem'uaz'kau	"	...
(Two lost)	"	...
Ra'khu'tai	"	1
Ra'mer'hotep	"	27
Ra'suah'en	"	...
Ra...uah'khau.	Sebekemsaf ?	...
(Three lost)	"	...
Ra'za.....	"	...
Ra'suaz'en	"	...
Ra'snefer...	"	87 ?
Ra.....	"	...

We have here followed the lines of names in the reverse order to that in which they read, as this is evidently the sequence of the Sebekhotep family. The order seems, however, to be so wild in the later part that it is hopeless to trust to it for any historical ideas.

On scarabs we meet with one of these names, namely, Ra'suaz'en, on four scarabs of very rude work (B. Mus., P. Mus., Koptos, and Sayce). And some names are only known from scarabs, as—

Ra'nefer (common)
 Ra'kheper
 Ra'nefer'ankh
 Ra'kha'neferui
 Ra'neb'neferui
 Ra'nub'neferui
 { Neferui'ka'dad'uah
 { Ka'ankh'et'nefer'kha
 Uaz'neferui (vassal of the above)
 Ra'nefer'nub
 Ra'set'pehti
 Ra'set'nub
 Ra'peh'nub
 Ra'nub'uaz
 Ra'nub'hotep (common)

There are also many other groups of signs which may perhaps be personal names, or else merely ornaments or emblems. As these are already published (P. Sc.), it is not needful to go further into them.

An unanswered difficulty with regard to the XIVth dynasty is the position stated for its capital. Xoïs is

identified with Sakha, in the central Delta rather on the western side. How it came about that on the invasion of the country from the north-east, the native rulers should appear to have backed to the west, instead of retreating up the Nile valley,—how it was that they should have been known by the name of a Delta town in the region of the invaders, instead of a southern town such as Thebes or Aswan,—is a hard question. There are various solutions which should be kept in view, to see if any further light can be thrown on them. (1) The dynasty may have originated at Xoïs, and have been dispossessed by the Hyksos southwards, holding yet a pre-eminence in the country above other native rulers as being the fighting frontier organisation to which others adhered. Thus it may not have ruled at Xoïs for any appreciable time, but have been a southern dynasty only starting from there. (2) Or the Hyksos may have overrun the country, and compelled the legitimate line to reside within their power in the Delta, so as to prevent revolt. (3) Or, as the Hyksos were a Syrian people not accustomed to wide rivers and marshes, it is possible that the lines of the Nile and canals were a better defence for the natives than any distance of retreat up the valley. At Sakha itself there are no signs of any important ancient town; and beyond one or two pieces of Roman work, it shows no antiquities; it might then be suspected that the real site of this dynasty was some southern city, the name of which was misread by Manetho, and converted into that of a town with which he must have been familiar, within a few hours' walk of his own home at Sebenny-tus. But no likely substitution can be suggested, such as that of Elephantine for Sakhebu in the Vth dynasty.

The nature of this dynasty, a long series of ephemeral rulers, reigning only two or three years on an average, is clearly artificial. They were, in fact, merely the puppets of the Hyksos power, the heads of the native administration which was maintained for taxing purposes; like the last Emperors of Rome, whose reigns also average two and a half years; or like the Coptic

administration of Egypt, maintained during the supremacy of Islam as being the only practicable way of working the country. Later on, when the Hyksos had established a firm hold on all the land, and had a strong rule of their own, these native viceroys were permitted a longer tenure of power, and formed the XVIth dynasty contemporary with the great Hyksos kings.

CHAPTER X

FIFTEENTH TO SEVENTEENTH DYNASTIES. THE HYKSOS.
ABOUT 2098-1587 B.C.

THIS period of the foreign domination of Asiatic invaders is so strongly marked that we cannot but treat it as a whole. Unfortunately, there are very few materials for the study of it; almost all our information is in the extract which Josephus made from the history of Manetho, which shows also what a real history the account of Manetho was, and how the lists that we possess are the merest skeleton of his writings.

Apion has conferred a great benefit on history, by stinging Josephus into framing a splendidly mistaken theory of the glory of the Jewish race in Egypt, which he elaborated with nationalist fervour, calling in the Hyksos to figure as Hebrews domineering over Egyptians. It is through this valuable error that what was known of these invaders, by the later Egyptians, has been preserved. The account is so important that it should be read in full, so far as the Hyksos period is concerned. He quotes from Manetho:—

“We had formerly a king whose name was Timaios. In his time it came to pass, I know not how, that God was displeased with us; and there came up from the East in a strange manner men of an ignoble race, who had the confidence to invade our country, and easily subdued it by their power without a battle. And when

they had our rulers in their hands, they burnt our cities, and demolished the temples of the gods, and inflicted every kind of barbarity upon the inhabitants, slaying some, and reducing the wives and children of others to a state of slavery.

“At length they made one of themselves king, whose name was Salatis : he lived at Memphis, and rendered both the upper and lower regions of Egypt tributary, and stationed garrisons in places which were best adapted for that purpose. But he directed his attention principally to the security of the eastern frontier ; for he regarded with suspicion the increasing power of the Assyrians, who he foresaw would one day undertake an invasion of the kingdom. And observing in the Saite nome, upon the east of the Bubastite channel, a city which from some ancient theological reference was called Avaris ; and finding it admirably adapted to his purpose, he rebuilt it, and strongly fortified it with walls, and garrisoned it with a force of 250,000 men completely armed. To this city Salatis repaired in summer, to collect his tribute and pay his troops, and to exercise his soldiers in order to strike terror into foreigners.” (For Saite perhaps read Sethroite.)

“And Salatis died after a reign of nineteen years ; after him reigned another king who was called Beon forty-four years ; and he was succeeded by Apakhnas, who reigned thirty-six years and seven months ; after him reigned Apophis sixty-one years, and Iantias fifty years and one month. After all these reigned Assis forty-nine years and two months. These six were the first rulers amongst them, and during the whole period of their dynasty they made war upon the Egyptians with the hope of exterminating the whole race.

“All this nation was stiled Hyksōs, that is, Shepherd Kings ; for the first syllable Hyk in the sacred dialect denotes a king, and sōs signifies a shepherd, but this only according to the vulgar tongue ; and of these is compounded the term Hyksōs. Some say they were Arabians. This people who were thus denominated

Shepherd Kings, and their descendants, retained possession of Egypt during the period of five hundred and eleven years.

“And after these things he relates that the kings of Thebais, and of the other provinces of Egypt, made an insurrection against the Shepherds, and that a long and mighty war was carried on between them, till the Shepherds were overcome by a king whose name was Misfragmouthōsis, and they were by him driven out of the other parts of Egypt, and hemmed up in a place containing about ten thousand acres which was called Avaris. All this tract (says Manetho) the Shepherds surrounded with a vast and strong wall, that they might retain all their property and their prey within hold of their strength.

“And Thummōsis, the son of Misfragmouthōsis, endeavoured to force them by a siege, and beleaguered the place with a body of four hundred and eighty thousand men; but at the moment when he despaired of reducing them by a siege, they agreed to a capitulation, that they would leave Egypt, and should be permitted to go out without molestation, wheresoever they pleased. And according to this stipulation, they departed from Egypt, with all their families and effects, in number not less than two hundred and forty thousand, and bent their way through the desert towards Syria. But as they stood in fear of the Assyrians, who then had dominion over Asia, they built a city in that country which is now called Judæa, of sufficient size to contain this multitude of men, and named it Hierosolyma.”

Now, summarising this account, with the additional light of the other indications that we have, the following outline lies before us.

The country was disorganised, and incapable of resisting any active foe, when from the East there poured in a barbaric people, who settled, and seized on the government of the country, harrying and plundering, while the native rulers were at their mercy. After a century of this confusion they be-

came more civilised, probably by the culture inherited from the Egyptian mothers of the second and third generation.

Then they established a monarchy of their own in the Egyptian fashion, adopting the usages of the country, and keeping native administrators in their power to claim the allegiance of the people. Six kings of this stable period are recorded; Salatis, the first, rebuilt Haur—probably Tanis—as a stronghold, while Memphis was adopted by him as his capital. The succession of the great kings was as follows—

XVTH DYNASTY.		B.C. about
Salatis	19 years	1998
Beon (Bnōn)	44	1979
Apakhnas (Pakhnan)	36 y. 7 mo.	1935
Apōfis	61	1898
Ianias (Sethōs)	50 y. 1 mo.	1837
Assis (Kērtōs + Asēth)	49 y. 2 mo.	1787
		1738

The variants are those of Syncellus and Africanus; but the latter alters the order, omitting the last two kings, and inserting after Pakhnan the names of Staan 50 years, and Arkhles 49 years—the same reigns as the last two here, but different names and successions. This is probably an error of Africanus, but may well embody two more of the Hyksos names, Staan and Arkhles, from a part of their list now lost to us.

The whole duration of the foreign dominion of this people and their descendants was 511 years. Then the Thebaid revolted, expelled them under Aahmes (Misfragmouthisis is quite a possible form from the known titles of the king; Aahmes pa·her·nub·thes·tau),

and restricted them to Tanis. Lastly, Tahutmes I. forced them to retreat into Syria, where they settled in the region of the hill country from which they had come (for the statement that Hebron was built seven years before Zoan, Num. xiii. 22, links the two cities together), or through which they had passed on their migration into Egypt.

As to the origin of the Hyksos race much has been written, though but little is certain. We cannot improve on the origin of the name given by Manetho: *hyk* or *heq*, a prince, and *sos* or *shasu*, the generic name of the shepherds or pastoral races of the eastern deserts. On later monuments the Shasu are represented as typical Arabs. This usage of *heq* for the chief is like that of the *heq setu* or "chief of the deserts," the title of the Semitic Absha in the XIIth dynasty, and of Khyan before him.

One evidence regarding the race, which has been largely relied on, is the peculiar physiognomy of many statues and sphinxes which have been attributed to this period (Figs.

140-143). The so-called Hyksos sphinxes of Tanis, the statue from the Fayum, that of the Esquiline at Rome, the colossi of Bubastis, and some smaller pieces in museums, all show one type of face,—high cheek-bones, flat cheeks, both in one plane, a massive nose, firm projecting lips, and thick hair, with an austere and almost savage expression of power, characterise all these works. That they are as old as the Hyksos cannot be doubted, as they bear Hyksos names cut upon them; but lately it has been ques-



FIG. 140.—Black granite fish-offerers, Tanis.

tioned whether they are not much older than these invaders. Though the Hyksos names are the oldest now legible on the figures, they are merely inscribed lightly on the right shoulder, like the name of Apepa on the right shoulder of Mermeshau at Tanis; and no Hyksos name occurs on the breast or between the paws of the sphinxes. Meyer has concluded that



FIG. 141.—Black granite sphinx, Tanis.

they belong to the invaders of the VIIIth-Xth dynasty; and as now Khyan is probably fixed to that period, we know that fine work in black granite or syenite was being done then. Unfortunately, the head of the Khyan statue has not been found; no matter how battered, it would have sufficed to show whether the "Hyksos type" belonged to the earlier or later invaders.

A new theory has just been proposed by Golenischeff (Rec. xv. 131), that the so-called Hyksos statues represent Amenemhat III. A statue of his, Fig. 108 (now at St. Petersburg) has some resemblance to the strange type; and a nameless statue belonging to Professor Golenischeff, which he illustrates along with the others, is undoubtedly of that type. But yet the Amenemhat is sufficiently distinct, in the lips, the chin, and the angle of the face,—even in its battered condition,—to make it difficult to accept it as a real origin of this strange type. If, however, that type belongs to Asiatic invaders during the IXth-Xth dynasty, it is obvious

how the XIIth may have intermarried with their descendants, and have shown some traits of their features. The admirable photographs which accompany the paper (in Rec. xv.) will enable a judgment to be formed on the question.

The only foreign parallel to this type of face is found among the foes of Ramessu II. in North Syria ; but as the question whether this peculiar race and their works



Fig. 142.—Granite head, Bubastis.

are to be classed with the IXth or the XVth dynasty cannot yet be really determined, the subject of the physiognomy of the Hyksos and their origin must still await a decisive settlement.

The question of portraiture being thus in abeyance, there is but one clue left to the origin of the Hyksos, in the names of their kings. Now, doubt-

ful as such a clue might be in one or two cases, yet when we find that the Greek forms would well represent such Semitic names as "the ruler," "the governor," "the oppressor," "the firm," and "the destroyer," it seems to give some weight to a Semitic origin for the people. Such names are more likely than a prominent

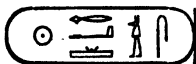

FIG. 143.—Granite head, Bubastis.

Semitic name of our own century, Jezzar Pasha, "the cutter" or "butcher"; and they are much in keeping with the character given to the Hyksos.

Of the actual remains there are but very few belonging to the Hyksos kings, and those only of Apepa I. and II.

XV. 4. RA'ĀA'USER

about 1898-
1837 B.C.

APEPA I.

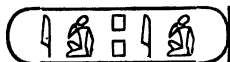
FIG. 144.—Cartouche of Apepa I,
Gebelen (G. Mus.).Bubastis,
Kahun,
Gebelen,
Papyrus mathematical
Palettes
Scarabs.Inscription
Stamp
Inscription(N.B. xxxv., c).
(P.K. xii. 16).
(Rec. xiv. 26).
(B. Mus.).
(Berlin).

The inscription at Bubastis with the name Apepa is upon red granite, and therefore was probably due to the first Apepa, one of the six great kings, who ruled the whole of Egypt. It records how Apepa had erected "many columns and a gate of brass to this god" (N.B. xxii. A, xxxv. c).

A wooden stamp found at Kahun (P.K. xii. 16) may belong to the king, or to a private person (F.P. Coll.).

A lintel found at Gebelen (Fig. 144) bears the name of "the living good god, Ra'aa'user," twice repeated (Rec. xiv. 26; G. Mus.). This is of great value as showing, what Manetho states, that both Upper and Lower Egypt were reduced by the great Hyksos kings.

Of small objects, there is a mathematical papyrus (B. Mus.) written in the thirty-third year of the reign

of this king (A.Z. xiii. 40 ; S.B.A. xiv. 29). Also two palettes at Berlin, with both names of the king (S. B. A. iii. 97). Several scarabs (Fig. 145) with the throne



FIG. 145.—Scarabs of Apepa I.

name are known, some of them very rude and blundered (B. Mus. 3 ; P. Mus. 2 ; Leyden ; F.P. Coll. 4).

XVII. RA'ĀA'QENEN

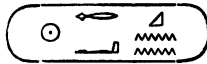

about
1650 B.C.

APEPA II.



Tanis
Memphis?
Statue usurped

Inscriptions
Altar
Louvre

(P.T.I. iii. 17 c).
(M.D. 38).
(W.G. 295).

The statues of Mer-meshau, at Tanis, have down the right shoulder of each a line of added inscription, small, and not very disfiguring. It reads: "Good God, Ra'aa'qenen, son of the Sun, Apepa, giving life, beloved of Set." The figure of Set was, however, honourably placed first in the inscription, but was carefully hammered out in later times. Very probably the other lines of erased inscriptions on the right shoulders of the sphinxes at Tanis were also of this

king. And a sphinx at Ismailiyeh (from Tell Mas-khuta) has a line of similar erasure on the shoulder, and the whole head has been recut, and the mat of hair on the shoulders and chest removed, by Ramessu II.

In Cairo a fine and perfect altar of black granite (Fig. 146) was found, dedicated to Set of Haur, or Avaris, by this king; it probably came from Memphis or Heliopolis (M.D. 38). Now in Ghizeh Museum.

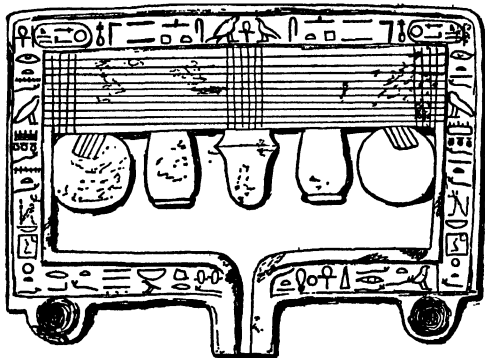

FIG. 146.—Black granite altar of Apepa II., Cairo (G. Mus.).

A statue in the Louvre has been read as of Apepa originally (W.G. 295), but usurped later by Amen-hotep III. It does not seem at all certain that the list of thirty-six conquered Nubian races belonged to the first owner, and it may be an addition put on by the usurper. That this king belongs to the XVIIth dynasty is indicated by his name, Aā'qenen'ra, being of the same type as that of Se'qenen'ra Ta'āā, with whom he is also associated in the tale of Apepa and Seqenenra (Sall. Pap. 1).

Perhaps of this same age is an obelisk at Tanis (Fig. 147), inscribed on all sides by a king RA·ĀA·SEH



Such a name is otherwise

unknown; but agrees in type to the throne names of the Apepas (P.T. I. ii. 20).

Lastly, there is the celebrated monument of Ramessu II., dated in the 400th year of "the king of Upper and Lower Egypt, Set·āa·pehti, son of the Sun,

Nubti·set, beloved of Horakhti" (A.Z. iii. 34). As this is the only monument dated with a fixed era in Egypt, it has naturally received much attention. The most reasonable view seems to be that this was a reckoning established by a Hyksos king, and used at Tanis continuously to the time of Ramessu II. It has also been shown that an entry in the lists of Africanus at the close of the XXIVth dynasty, of 990 years, is perhaps in accord with this era (A.Z. xvii. 138).¹ As the last of the great Hyksos kings, Aseth (or Assis), is stated by Syncellus in his extracts to have revised the calendar, it is the more likely that some such era was established then. This statement is not, however, satisfactory, as he is said to have added the 5 days to the year of 360 days, which are known to have been in use long before his time; but it may well be that some other reformation has been thus misstated. The actual interval from Aseth to Ramessu I. is about 151 + 260 years or 411 years, thus leaving nothing for the reign of Sety I., and for the portions of the end of the reign of Aseth and beginning of that of Ramessu II.

The period of 990 years from the time of Beken·ran·f of the XXIVth dynasty, would yield about 720 + 990 = 1710 B.C. for the date of king Set·aa·pehti, within about

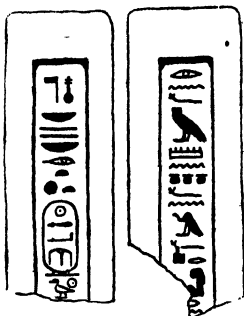

FIG. 147.—Obelisk of Ra·āa·seh, Tanis.

5 years of uncertainty; and similarly the date $720 + 590 = 1310$ B.C. ought to fall within the reign of Ramessu II. But from the chronology, so far as we can now reckon it, this would be about 35 years too early for Ramessu II., though the Hyksos date would easily fall within the wide limits of their period. Hence this use of the 990 years does not seem very satisfactory.

A few names that are hitherto quite unfixed in position, but which probably precede the XVIIth and XVIIIth dynasties, require to be mentioned.

RA·DAD·NEFER



DUDU·MES



FIG. 148.—
Scarab (F. P. Coll.).

This king has been found on a scene at Gebelen, representing him being conducted by Khonsu to Anpu. He is referred to the XVIth dynasty by Daressy (Rec. xiv. 26); but from the occurrence of the name with graffiti of Pepy, he is placed in the VIIth-VIIIth dynasty by Sayce. From the style of a scarab of his (F.P. Coll.), it appears that the Xth dynasty would be about his period (Fig. 148).

RA·SE·BEQ·KA



This name occurs on a cylinder (Fig. 149) from Kahun (P.I. viii. 36) as the name of a king, "nefer neter . . . beloved of Sebek lord of Sunu." It belongs to the XIIIth or XIVth



FIG. 149.—Cylinders (F. P. Coll.).

dynasty apparently; and a similar cylinder was recently sold at Luxor (both F.P. Coll.).

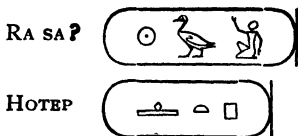

These names occur together on the rock (Fig. 150) of the Shut er Regal valley (P.S. 430). Possibly the bird reads *sa*, and this might thus be the same as No. 48 in the Turin list.

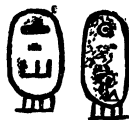

FIG. 150.—Rock marking, Silsileh.



This occurs on a stone at Gebelen (S.B.A. xv. 498).

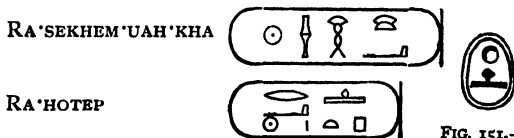

FIG. 151.—Scarab (F.P. Coll.).

Stele. Koptos.
Ostraka, subsequent tale (P. Mus.; F. Mus.).
Scarabs.

The only contemporary monument of this king is a much broken stele just found at Koptos. From that it appears that he had rearranged and endowed the

temple there after a period of decay. His date and position are yet unfixed, but the titles, *Hor Uah'ankh*, lord of vulture and uræus *User'ra'ren'pitu*, *Hor nub Uas* . . . , are akin to those of the early XVIIIth dynasty, and indicate that he did not long precede that. On the other hand, the resemblance of the throne name to those of Sebekemsaf I. and Uputemsaf would point to a close connection with the XIIIth dynasty. Possibly this group of kings may be those of the XVIth dynasty under the great Hyksos kings, midway between the XIIIth and the XVIIIth, to each of which the names bear a resemblance. The stele is of rather rough work, and unhappily the top scene has nearly all been lost.

The portions of a tale concerning Rahotep are on ostraka of a later age, about the XXth dynasty (P. Mus. ; F. Mus.), in which mention is made of going to the tomb of king Rahotep, and at that place a mummy speaks, and states that "When I lived on earth I was treasurer of king Rahotep, and I died in the 14th year of king Ra'men'hotep" (Rec. iii. 3, xvi. 31 ; Contes Populaires, 291). Some few scarabs are known, all of small size, and not distinctive.

CHAPTER XI

NOTES ON CHRONOLOGY

ALTHOUGH the questions of the Egyptian chronology are among the most difficult, they are also among the most essential to be considered. The various data that exist need that full discussion, in the light of modern knowledge of the subject, which they have never yet had. To treat them properly would entail a length of research, and an elaboration of treatment, which is quite beyond the scope of a history such as this. Yet, until such a work is undertaken, some provisional results are required for use; and I only propose here to go briefly over the outline of the materials which we have already noticed, and to connect that with the most prominent fixed data that we have. The results must, of course, be stated in years according with our era, but that will not therefore imply that we are certain of our results to within a year; only that, as we have often to consider short spaces of time during a dynasty, it is needlessly clumsy to deal with only round tens or hundreds of years. The figures in years, then, are only good for short differences of age, and we must always remember what our uncertainties are. The chronology rests on two modes of reckoning: (1) that by "dead reckoning," or adding the dynasties up one on another; (2) by certain fixed astronomical data, into the interpretation and calculation of which various uncertainties may enter. The more apart these modes can be kept the better, as then they serve to check each other.

The fundamental fact on which all of our astronomically fixed points depend is the imperfection of the Egyptian calendar. Using a year of 365 days, it followed that the nominal beginning of each year was a quarter of a day too soon: just as if we were to neglect the 29th of February in leap years, and go on always from 28th February direct to 1st March. Thus every four years a day was slipped, and the nominal months of the year were begun a day too soon. In $4 \times 7 = 28$ years they began, then, a week too soon. In $4 \times 30 = 120$ years they began a month too soon; and after twelve months and five days thus slipped, or in 1460 years, they began a year too soon, and so had rotated the nominal months through all the seasons. This would not cause any trouble to any one generation of men, as the change in one man's life would not be more than two or three weeks; hence this slow shift would be unperceived in the affairs of daily life; and as the Egyptians were not addicted much to historical researches, they would not be thrown out by finding that the harvest or inundation could occur in any month of the year, according to the date of their research.

This loss of the day in four years was, however, soon known to the Egyptians, and used by them as a mode of constructing a great cycle, which in Ptolemaic times became very prominent, and entered into all their fanciful adjustments of history and myths.

Some mode of noting the absolute months, as related to the seasonal periods, became a necessity; and, of course, the place of the sun among the stars most truly shows the exact length of the year. But how to observe both sun and stars, when without any mode of time-dividing,—such as clepsydra or clock,—was an essential difficulty. This was got over by noting on what day a particular star could be first seen, at its emerging from the glow of the sunlight. In actual practice they observed Sirius (or Sothis), the dog-star; and as the stars all rise and set earlier and earlier every night, they observed what was the first night in the year on which Sirius could just be seen emerging from the glow of sunlight

at dawn, and this was entitled the heliacal rising. Hence, from using Sothis for this observation, the whole period during which the months rotated in the seasons was called the Sothic period of 1460 years. We have some definite statements as to this in Roman times. Censorinus, writing in 239 A.D., states that the Egyptian New Year's day, 1st of Thoth, fell on the 25th of June; and a hundred years before, in 139 A.D., it fell on the 21st July, "on which day Sirius regularly rises in Egypt." Hence the beginning of a Sothic period of 1460 years, or the New Year's day falling on the 21st of July at the heliacal rising of Sirius, took place in 139 A.D.; likewise in 1322 B.C., in 2784 B.C., and in 4242 B.C., or thereabouts.

From this it is plain, that, as the nominal months rotated round all the seasons once in each of these cycles, therefore, if we only know the day of the nominal month in which any seasonal event happened,—such as the rising of Sirius, or the inundation,—we can find on what part of the cycle of 1460 years such a coincidence can have fallen.

It is from data such as this that Mahler has lately calculated, by the rising of Sirius, and also the new moons, that Tahutmes III. reigned from 20th March 1503 B.C., to 14th February 1449. And though it would be very desirable to use all the data of the kind together in one general discussion, yet until this is done we may provisionally accept Mahler's calculation as a basis.

This, fortunately, has two checks, one on either side of it; and, for the sake of clearness, we will use Mahler's datum provisionally. First, we must outline the dates of the XVIIIth-XIXth dynasty, as reckoned out by the best information we have, on the reigns and the relationships; and though we may be doubtful within ten years about it, yet it will suffice to show if the other astronomical dates are near the mark.

The reasons for this arrangement of the XVIIIth dynasty cannot be entered on here, but will be dis-

cussed in the next volume. Provisionally, I arrange it thus—

	B. C.		B. C.
Aahmes I.	1587	Amenhotep IV.	1383
Amenhotep I.	1562	Rasmenkhka.	1365
Tahutmes I.	1541	Tutankhamen.	1353
Tahutmes II.	1516	Ay.	1344
Hatshepsut.	1503	Horemheb.	1332
Tahutmes III.	1481	Ramessu I.	1328
Amenhotep II.	1449	Sety I.	1327
Tahutmes IV.	1423	Ramessu II.	1275
Amenhotep III.	1414	Merenptah.	1208
	1383		

But many small questions, of coregencies, etc., are necessarily uncertain. The total for the XVIIIth dynasty comes out as 260 years against Manetho's 263.

Now, one good datum is, that Merenptah celebrated in the second year of his reign a festival of the rising of Sirius on the 29th of the month Thoth. Mahler has fixed the rising of Sirius, recorded on 28th Epiphi under Tahutmes III., as in 1470 B.C. From 28th Epiphi to 29th Thoth is 66 days, which the heliacal rising would change to in the course of 4×66 years, or 264 years. This, from 1470, gives 1206 B.C. for the second year of Merenptah, or 1208 B.C. for his accession, which is just the date we have reached by the approximate summing of the reigns.

Another datum on the other side is the calendar of the Ebers papyrus, which records the rising of Sirius on the 9th of Epiphi in the ninth year of Amenhotep I. The reading of the king's name has been much debated; but this is the last, and probable, conclusion. Now, from the 28th to the 9th of Epiphi is 19 days, which Sirius would change through in 76 years; so that the rising on the 9th of Epiphi took place in $1470 + 76 =$

1546 B.C. ; and the first year of Amenhotep I. would be thus fixed in 1555 B.C. The date before reached is 1562 B.C., equal to a difference of less than 2 days in the time of Sirius' rising. This, at least, shows that there is no great discrepancy. Thus there are three data for the rising of Sirius, which agree within a few years, though at considerably different epochs. The whole question of the exact epoch depends on the observations and calculations as to the rising of Sirius ; those, however, cannot be very far in doubt, and these three data leave no doubt of the general interpretation of the materials, and assure us of the general position of our results.

We therefore have as a starting-point for our backward reckoning the accession of the XVIIIth dynasty about 1587 B.C. From this we can reckon in the dynastic data given by Manetho ; following this account rather than the totals of reigns, as he appears to have omitted periods when dynasties were contemporary, as in the 43 years for the XIth after the close of the Xth. Thus, from the above starting-point of 1587 B.C., we reach the following results, solely by using material which has been discussed and settled in this history on its own merits alone, and without any ulterior reckoning in total periods.

	YEARS	B.C.		YEARS.	B.C.
Dynasty	I. 263	4777	Dynasty	X. 185	3006
"	II. 302	4514	"	XI. 43	2821
"	III. 214	4212	"	XII. 213 (T.P.)	2778
"	IV. 277	3998	"	XIII. 453	2565
"	V. 218	3721	"	XIV. 184	2112
"	VI. 181 (T.P.)	3503	"	XVI. 190	1928
"	VII. 70	3322	"	XVII. 151	1738
"	VIII. 146	3252	"	XVIII. 260	1587
"	IX. 100	3106	"	XIX.	1327
		3006			

For all the earlier periods we have but one check, and that a vague one. We know that when Una quarried alabaster at Hat-nub—or Tell el Amarna—he did it in 17 days of the month Epiphi; and that yet he could not get it down to the pyramid before the Nile began to subside. There are some rather vague points about this, as the part of the month of 30 days in which the 17 fell, the time required to get down, which would perhaps be only 6 or 8 days (as Hat-nub is not so far up the Nile as was supposed when this was considered before, P.S. 20), and the time of the Nile falling. Putting the fall at about November 5, the boat would have left Hat-nub about October 28; and the 17 days would be to October 11. Hence Epiphi would fall within 6 days of October 5 to November 5. This date would be that of Epiphi at about 3350 B.C., if we reckon the 1460 year periods back from 139 A.D. What small differences might be made by a fuller consideration of the details of the 1460 period we cannot at present say. At least, the result would not be widely different from this, probably within a century of it. Having, then, 3350 B.C. for the reign of Merenra, and adding about 60 years, we reach about 3410 B.C. for the beginning of the VIth dynasty, with an uncertainty (to put it liberally) of 50 or 100 years.

This 3410 B.C., then, should be equal to the date that we find by the dead reckoning of dynasties back from the XVIIIth to the VIth, which is given in that way as 3503 B.C. And this shows that we have to deal with errors which are probably within a century, and that we are not left with several centuries of uncertainty.

In the present rough state of the astronomical data, and the doubts as to the MS. authorities, we have reached quite as close an equivalence as we may hope for; and at least there is enough to show us that we may trust to the nearest century with fair grounds of belief.

These dates, then, are what I have provisionally adopted in this history; and though they are stated to

the nearest year, for the sake of intercomparison, it must always be remembered that they only profess to go to within a century in the earlier parts of the scale. I only wish it were possible to repeat this on every occasion of stating a date ; it cannot be too well remembered.

INDEX

*All Ra names of kings are placed together under Ra. K, King,
Q, Queen, pr, Priest.*

- AA, K, 109, 117.
 Aa'ab, K., 206, 219.
 Aahmes, pr., 31*, 32.
 Aahmes Nefertari, Q., 29.
 Aa'hotep'ra, K., xxi, 190, 117.
 Aam, Q., 132.
 Aam (Lower W. Nubia), 94, 99.
 Aasen, pr., 26*.
 Aba, pr., xx, 102.
 Absha, 172.
 Abydos, table of kings, 11.
 „ tombs at, 2, 11.
 Ada, 151.
 Adu I, pyramid keeper, xx.
 Adu, pr., xx, 91, 98, 102.
 Affa, pr., 71.
 Aha-mena, K., 10, 13-15.
 Ahy, pr., 98.
 Aimery, pr., 42, 72, 73, 74.
 Aimhetep, K., 37, 37*, 66.
 Aken, 181.
 Akherkin, 163.
 Akhes, K., 23*, 29, 32.
 Akhet'hotep, pr., xix, 76, 78,
 79, 84.
 Akhet'hotep'her, pr., 73.
 Alabaster quarry, 45, 95, 253.
 „ vases, 76, 88, 104.
 Amenemhat I, K., Dendera,
 xxii, 145, 148.
 „ II, K., Mitraheny,
 xxxiii, 145, 164.
 Amenemhat III, K., xxv, xxvi,
 145, 184.
 „ III and IV, to-
 gether, xxiv.
 „ IV, K., 145, 196.
 „ „ sphinxes, xxiv.
 Amenemhat Sebek-hotep, K.,
 xxv.
 Ameny (short for Amenemhat),
 165.
 Ameny Antef Amenemhat, K.,
 206, 207.
 Ameny'senb, 103.
 Amtes, Q., 94.
 Amu (Eastern Semites), 94, 120,
 155, 172, 193.
 An, K., 75.
 Ana, K., 206, 220.
 Ana'ankh, 76.
 An'ab (see Snaa'ab), K., 226.
 An'ab, K., 228.
 Animal worship, 25.
 Ankef, pr., 26*.
 Anket'dudu; 211.
 Ankh'em'aka, pr., 72, 76.
 Annals of kings, 12.
 Annu, K., 109.
 An'ren, K., 206.
 Antef (official), 151.
 Antef'a (prince), xxi, 126.
 Antefaqer, xxii.
 Antef I, K., 109, 124, 127.

- Antef II, K., 109, 124, 128.
 „ III, K., 109, 124, 129.
 „ IV, K., xxii, 109, 124,
 133.
 „ V, K., xxii, 109, 124,
 135.
 „ VI, K., 124, 141.
 Antefs, position of, xxi.
 Ant-har, xxi.
 Anu, K., 206.
 Anu (Nubians), 183.
 Apa'ankh, 88.
 Apakhnas, K., 234, 236.
 Apepa I, K., 234, 236, 241.
 „ II, K., 242.
 Apis, pyramid for, 30*.
 „ worship of, 25, 31.
 Apophis, K., 234, 236.
 Api'ankhu, pyramid keeper,
 xxi.
 Apy, inscription, xix.
 Aquiline race, 3.
 Architecture, 35*.
 Arqo, 216.
 Art, teaching of, 140.
 Arthet (Upper W. Nubia), 94,
 99.
 Asa, pr., 87.
 Assa, K., xviii, xix, 79, 100.
 Assa'kha, pr., 91.
 Assis, K., 234, 236.
 Asyut, tombs, 115.
 Ata, K., 10.
 „ pr., 72, 72, 76, 91.
 Ateth, K., 10, 18*.
 Athothis, K., 10, 17.
 Ati, pr., 78.
 Atmu'neferu, 171, 175.
 Atush, pr., 79.
 Aty, K., 86, 88.
 „ inscription, xix.
 Aufni, K., 206.
 Auhet'abu, Q., xxvi, 211.
 Ay, K., 206, 220.
 Azab-Merpaba, K., 10, 20*-21*.
 BA'NETERN, K., 23*, 24, 25.
 Ba'ur'dedu, 100.
 Bebn'm....., K., 227.
 Beby, K., 23*, 24, 29*.
 Bener-ab, 14.
 Beni Hasan, tombs, 149, 159,
 165, 172.
 Beou, K., 234, 236.
 Bezau, K., 23*-25.
 Bienekhes, 10.
 Bikheris, K., 37.
 Binothis, K., 23*, 24.
 Birket Qurun, 190.
 Boethus, K., 23*, 24.
 Brickwork, panelling of, 51.
 Bubastis, chasm at, 25.
 Bulls, worship of, 25, 31.
 Burial customs, 35*, 155.
 Buto, founding of, 17.
 CANAL of the cataract, xxiv,
 179.
 „ of Mena, 15.
 Chamberlains, 14, 23.
 Chronology, vi, 95, 110, 146,
 198, 201, 244, 248-254.
 Copper tools, 30.
 Cylinders, earliest, 55.
 DAD'KA'SHEMA'RA, K., 108.
 Dates of Dynasties, 252. (See
 Chronology.)
 Dating of papyri, xxiv.
 „ on monuments, 157.
 Debehen, 55.
 Den-Merneit, K., 10, 19, 19*.
 Den-Setui, K., 10, 19-20*, 23.
 Deng, dancer, 100.
 Dep'em'ankh, pr., 33*, 42, 53,
 55, 71, 72, 84.
 Deposition decree, 136.
 Dogs on Antef stele, 134.
 Dua-ra (pyramid keeper), 33*.
 Dudu, pr., 33*.
 Dudumes, K., xx, 245.
 Dynastic Egyptians, 4.
 „ lists, authority for,
 10, 11, 13.
 Dynasties, Thinite kings, 1-9,
 29.
 „ 1st, 10.
 „ hereditary succes-
 sion in, 25*.
 „ IInd and IIIrd, 23*.,

- Dynasties**, IVth, 37.
 " Vth, 13, 68.
 " VIth, 86.
 " VIIth-Xth, xx, 108.
 " XIth, 124.
 " growth of, 143.
 " XIIIth, 145.
 " character of, 199.
 " XIIIth, 201, 206.
 " XIVth, 201, 227.
 " XVth, 201, 236, 241.
 " XVIth, 201.
 " XVIIth, 201.
 " XVIIIth, reigns of, 251.
 " dates of, 252.
- EDOM**, 154.
 Egyptians, origin of, 4.
 Elephantine, 70.
- FAYUM**, 151, 159, 168, 193, 213.
 " development of, 190.
 Foreign invaders, 118, 172.
 Forged rock inscription, 31*.
 Four hundred year stele, 244.
 Fu'ab'ra, xxiv, xxvi.
 Funeral customs, 35*, 155.
- GRANITE temple**, 48.
 Griffith, Mr. F. Ll., vii.
- HA**, 25*.
 Ha, Q., 5.
 Ha'ankh'f, 213.
 Ha'ankh's, Q., 218.
 Haaui, Q., 14.
 Hapa, pr., 87.
 Hapenmaat, Q, 28-29, 31.
 Hapi'dua, pr., 76.
 Hapu, K., 206, 221, 227.
 Ha sa, title of royal tribes, 21.
 Hatnub quarry, 46, 253.
 Hatshepsut, Q., 62.
 Hawara, 184-189.
 Heliopolis, temple of, 157.
 Heliopolitan Vth dynasty, 69, 85.
 Hemaka (chancellor), 20*.
 Henka, pr., 33*.
- Hent'sen, 38.
 Hent'taui, Q., xxiv, 176, 183.
 Herkhuf, letter, xx, 99.
 Herodotos, 40, 191, 193.
 Hesat, pr., 79.
 Hesepti, K., 10.
 Hetep'hers, pr., 42.
 Hewn stone first used, 36.
 Hezefa....., K., 23*, 24, 28.
 Hor..... (or Har, or Heru), K., xxiv, xxv, 228.
 Hor, pr., 153.
 Hora, K., 206.
 Hor'akau, K., 75.
 Hor'dad'f, 63.
 Hor'kau'ra, K., 109.
 Hor'meren, K., 108.
 Hor'nefer, 144.
 Hor'nefer'hen, K., xx, 106.
 Hor'nefer'ka, K., 108.
 Hor'nefer'sa, K., xx.
 Hor-nub-khet fort, 22*.
 Hor'uah'ankh, K., 133.
 Hor-zeser-nub fort, 22.
 Horus and Set worshippers, 28*, 29.
 Hotep, K., 246.
 Hotep'ahau, K., 24, 24*.
 Hu excavations, xxv, xxviii.
 Huni, K., 23*, 29, 32.
 Hyksos, 202-205, 228, 231, 233-247.
 " statues, so-called, 237-240.
 Hymn to Usertesen III, 182.
- IANIAS**, 234, 236.
 Im'hotep (see Ain'hetep), 66.
 Imhotep, pr., 33*.
- JEBEL AHMAR**, 154.
 Jewellery of Sat-hathor, 177.
- KA names**, 148.
 Ka'ankh'et'nefer'ka, 230.
 Ka-ap, K., 3, 5.
 " tomb of, 5, 9.
 Kaau, 94.
 Ka'em'nefert, pr., 42, 53, 72, 76.

- Ka'em'retu, pr., 76.
 Kahap, pr., xviii.
 Kahun papyri, xxiv.
 " town, 171.
 Kaiekhos, K., 23*, 24.
 Kaka, pr., 92.
 Ka'ka'a, K., xviii, 74.
 Ka'ka'hekenu, Q., 74.
 Ka'kau, K., 23*, 24, 25, 31.
 Ka-neter, 24.
 Karna, list of, 229.
 Kas, 163.
 Kasekhem, K., 24.
 Kay, pr., 42.
 Kebh, K., 10.
 Ked'khenes, pr., 78.
 Kema, 213.
 Kemsa, tablet, xxiii.
 Kenkenes, K., 10.
 Kerferes, K., 23*, 24, 29, 29*.
 Kertos, K., 236.
 Kha-au, K., 12.
 Kha-ba, K., 36.
 Khafra, K., 34, 34*.
 " statues of, xvii.
 Khaires, K., 23*, 24.
 Kha'kau'ra, K., xxiv.
 Kharya, pr., 31*.
 Kha'sekhem, K., 27-28.
 Kha'sekhemui, K., 24, 27-29.
 Khemten, pr., 42.
 Khenems (vizier), xxv.
 Khen'em'su tomb, xxiv.
 Kheneres, K., 23*, 24, 28.
 Khen'zer, K., xxvii, 226.
 Khesaa, 163.
 Khety, K., xxi, 108, 109, 114,
 115.
 " (vizier), 130.
 Khnum'hotep, pr., 71.
 " tomb, 149, 165.
 Khnum Khuf, K., 43.
 Khokhome, 19*.
 Khua, 95.
 Khufu, K., 34, 36, 37*, 38.
 " block at Tideh, xvii.
 " at Hierakonpolis,
 xvii.
 " tomb of, 22.
 Khufu'ka'aru, pr., 42, 47.
 Khyan, K., xxi, 109, 118.
 Kings, lists of, 10-13. (See
 Ra.)
 Kush, 160.
 LABYRINTH, 187.
 Large-eyed race, 3.
 Libyan race in Egypt, 3.
 " revolt, 27*, 30.
 Lisht, fragments at, 53.
 " pyramid of, xxii.
 Lists of kings, 10-13. (See Dy-
 nasties.)
 MAA'AB'RA, K., xxi, 109, 116.
 Maat'kha, 64.
 Manefer, pr., 79.
 Manetho cited, 1, 10.
 Mastaba form, 32*.
 Mastabat el Faraun, xix, 83.
 Medum pyramid, 32-33.
 " tombs, 34, 35*.
 Mehti'em'saf, 86, 97, 104.
 Mekhet, K., 12.
 Memphis, Apis worship at, 25.
 " founder of, 1.
 " importance of, 29.
 " palace at, 17.
 " scribe of, 31*.
 Mena, K., Queen of, 9.
 " K. (XIIIth dyn.), 206,
 221.
 " pyramid keeper, xx.
 Menes=(Mena), K., 1, 10.
 Men'ka'ra Q. (VIth dyn.), 86,
 104.
 Men'kau'hor, K., 61, 68, 78.
 " obelisk of, xix.
 Men'kau'ra, K. (IVth dyn.),
 xviii, 55.
 Menkheres, 37.
 Ment (princess), xxiv.
 Mentu'em'saf, K., xxvi.
 Mentuhoteps, date of, xxi.
 Mentuhotep I, K., xxii, 109, 124,
 127.
 " II, K., 109, 124,
 131.
 " III, K., xxii, 109,
 124, 138.

- Mentuhotep, Q., xxvi, 144.
 " divine father, 211.
 Mera, pr., 87, 91.
 Mer'ab, pr., 42.
 Mer'ba'p, K., 10.
 Mer'en'ra, K., xx, 86, 97, 104.
 Meri's'ankh, Q., 34, 34*.
 Mer'meshau, K., 206, 209, 242.
 Mer'seger, Q., xxiv, 183.
 Mersekha-Shemsu, K., 10, 21*,
 22, 23.
 Mertisen, artist, 140.
 Mertitefs, Q., 34, 34*.
 " statue of, 37.
 Merysankh, Q., 32.
 Meryt (princess), xxiv.
 Mesokhris, K., 23*, 24, 29, 31*.
 Methen, pr., 33*.
 Mezau (S. Nubians), 94, 152.
 Miebidos, K., 10.
 Min'hon, pr., 71.
 Moeris, lake, 190.

 NAQADA tomb, 14-16.
 Nar'mer, K., 3, 7-9.
 Neb'em'akhet (prince), 34*.
 Neb'hotep, K., 127.
 Nebka, K., 23*, 24, 29-30.
 Neb-ka-ra, K., 23*, 30.
 Nebt, 95.
 Neby, K., xx, 108, 113.
 Nef'er'ab'ra, pr., 42.
 Nef'er'ar'ka'ra, K. (Vth dyn.),
 xviii, 68, 73.
 " K. (VIIIth dyn.),
 109.
 Nef'er'art'nef, pr., 72.
 Nef'er'fra, K., 68, 75.
 Nef'er'hotep, K., 206, 212.
 Nef'er'ka, K., 108.
 Nef'er'ka'ra, K. (IInd dyn.), 13,
 23*, 24, 27.
 " (IIIRD dyn.), 29,
 29*, 32.
 " (VIth dyn.), 86,
 101.
 " (VIIIth dyn.), 108,
 113.
 Nef'erka-sekru, K., 23*, 29*.
 Nef'erkheres, K., 23*, 24.

 Nef'er'maat, tomb, 35, 35*.
 " pr., 53.
 Nef'er's, K., 108.
 Nef'er-sa, K., 35*.
 Nefert, 35.
 " Q., 174.
 Nefert'hent, Q., xxiv.
 Nef'erui'ka'dad'uah, K., 230.
 Nef'eru'ptah, xxii.
 Nehab, K., 12.
 Nehesi, K., xxvii, 221.
 Neit-hotep, Q., 9, 14-16.
 " honouring of, 29.
 " tomb of, 30*.
 Ne'ka'ankh, pr., 71.
 Nekheb, 27*.
 Nekherofes, K., 23*, 24, 29-30.
 Nekht (prince), xxii.
 Nekht'abs, pr., 76.
 Nen'khetef'ka, pr., 71, 72.
 Nenna, Q., 211.
 Nenu, K., 227.
 Net'aqerti, Q., 86, 104.
 Neter-bau, K., 23*.
 Neteren, K., 12, 24-25*.
 Neter'ka, K., 23*, 24.
 Neter'ka'ra, K., 86, 104.
 Neter-khet, K., 29, 30*.
 Nile, honey legend of, 27.
 " levels of, registered, 13,
 193, 209.
 Nitokris, Q., 105.
 Nub'em'hat, Q., 218.
 Nub'hotep'ta'khredet, 208.
 Nubian affairs (Vth dyn.), 94,
 99.
 " (XIIIth dyn.), 152,
 160, 163, 178-181.
 Nub'kha's, Q., 224.
 Nubt'hotep, xxvi.

 OBELISK of Begig, 150.
 Obelisks, caps of, 157.
 " of Ra, xviii, 65, 71.
 Officials, 19*, 20*, 22*, 23.
 Organisation of government,
 149.

 PAHKMAN, K., 236.
 Palermo stone, 11, 72.

Papyrus, oldest dated, 81.
 Pa'seb'khanu, K., 44.
 Pedunebti, K., 228.
 Pehenuka, pr., 71, 73.
 Penens.....n'sept, K., 228.
 Pepy I, K., xix, 86, 89.
 ,, II, K., xx, 86, 101.
 Pepy'na, pr., 91, 98.
 Pepy'senb, K., 109.
 Perabsen, K., 24, 25*-26*.
 ,, K., names of, 28*.
 Persen, 63.
 Poem of praise, 182.
 Prehistoric ages, 1.
 Psemtek, pr., 63.
 Psemtek'menkh, pr., xvii, 42,
 53, 63.
 Ptah'bau'nefer, pr., 42, 72, 73,
 76.
 Ptah'du'aau, pr., 63.
 Ptah'en'kau, xix, 89.
 Ptah'en'maât, pr., 73.
 Ptah'hotep, pr., 71, 74, 75, 78.
 ,, proverbs of, xix,
 81.
 Ptah'kha'bau, pr., 72, 73, 75,
 76.
 Ptah'nefer'art, pr., 78.
 Ptah'neferu, pr., 187, 188, 195.
 Ptah'ru'en, pr., 73.
 Ptah'se'ankh, pr. (VIth dyn.),
 91.
 ,, (XVIth? dyn.),
 xxviii.
 Ptah'shepses, xviii, 64.
 ,, pr., 84, 87.
 Ptolemy Soter, K., 192.
 Punt, 100, 141, 167.
 Pyramids, designs of, xvii, 32*,
 33, 39, 57, 90, 169,
 176, 184.
 ,, development of, 33.
 ,, sections of, 33, 57,
 83.
 ,, theory of restora-
 tion, 58.
 ,, two of one king, 31*,
 33*, 55, 84.
 ,, of Abu Roash, 56.
 ,, of Abu Sir, 71, 76

Pyramids of Dahshur, 176.
 ,, of Gizeh, 33, 38, 47
 56.
 ,, of Hawara, 184.
 ,, of Illahun, 168.
 ,, of Khokhome, 19*.
 ,, of Medum (earliest)
 32-33, 39.
 ,, of Riqqeh, 77.
 ,, of Saqqara, xviii, 30*
 33, 82, 87, 90, 97.
 ,, of Thebes, 133.

QA, K., 21.

Qa-Sen, K., 10, 22-23.

Qau, 19*.

KINGS' NAMES.

RA'AA'HOTEP, 109, 117.
 Ra'aa'qenen, 242.
 Ra'aa'seh, 244.
 Ra'aa'user, 241.
 Ra'ab'mery, 109, 114.
 Ra'amen'em'hat, 206.
 Ra'ankh'ka....., 227.
 Ra'dad'ankh, xxvii.
 Ra'dad'ef, 34, 63.
 Ra'dad'ka, 79.
 Ra'dad'kheru, 227.
 Ra'dad'nefer, 245.
 Ra'dadui'ankh, xxi.
 Ra'ded'f, 37.
 Ra'en.....er'ka, xxvii.
 Ra'en'ka, 108, 113.
 Ra'en'maa'en'kha, 226.
 Ra'en'maat, xxiv, xxv, 184.
 Ra'en'user, xviii, 75.
 ,, pr., xix.
 Ra'fu'ab, xxv, 206, 208.
 Ra'ha'shed....., 227.
 Ra'hathor'sa, 206.
 Ra'her'ab, 227.
 Ra'hotep, xxviii, 246.
 Ra'hotep'ab, xxv.
 Ra'ka, 24, 26*.
 Ra'ka.....ab, 227.
 Ra'ka'mery, xxi, 109, 115.
 Ra'kha....., 227.
 Ra'kha'ankh, 206, 218, 229.
 Ra'khaf, 37, 47.

- Ra'kha'hotep, 206, 219, 229.
 Ra'kha'ka, 206, 217, 229.
 Ra'kha'kau, 176.
 Ra'kha'kheper, 168.
 Ra'kha'nefer, 206, 215, 229.
 Ra'kha'neferui, 230.
 Ra'kha'seshes, 206, 212, 229.
 Ra'kha'thi, 206.
 Ra'kha'user, 109, 117.
 Ra'kheper, 230.
 Ra'kheper'ka, 156.
 Ra'kheper'kha, 168.
 Ra'khu't'ai, xxv, 206, 230.
 Ra'maa'ab, 109, 116.
 Ra'men'hotep, 247.
 Ra'men'ka, 104.
 Ra'men'kau, 37, 55.
 Ra'men'khau, 226.
 Ra'mer'en, 97, 104.
 Ra'mer'hotep, 206, 220, 230.
 Ra'mer'kau, 206, 220, 229.
 Ra'mer'kheper, 206.
 Ra'mer'nefer, 206, 220.
 Ra'mer'sekhem, 206, 230.
 Ra'mer'user, xxi.
 Ra'mery, 89.
 Ra'mer'zefau, 227.
 Ra'messus II, 10, 171.
 Ra-neb, 21, 24-25.
 Ra'neb'ati'au, 227.
 Ra-neb-ka, 23*, 30.
 Ra'neb'kha, 106.
 Ra'neb'khepesh, xxviii.
 Ra'neb'kher, 138.
 Ra'neb'maat, 206, 220.
 Ra'neb'neferui, 230.
 Ra'neb'sen, 227.
 Ra'nefer, xxiv, 230.
 Ra'nefer'ab, 227, 229.
 Ra'nefer'ankh, 230.
 Ra'nefer'ar'ka, 73, 109.
 Ra'nefer'f, 75.
 Ra'nefer'ka (IInd dyn.), 13,
 23*, 24, 27.
 ,, (IIIrd dyn.), 29,
 29*, 32.
 Ra'nefer'kau, 109.
 Ra'nefer'nub, 230.
 Ra'nefer'tum....., 227.
 Ra'nehesi, 206, 221.
 Ra'neter'ka, 104.
 Ra'nezem'ab, 206.
 Ra'nub'hotep, 230.
 Ra'nub'kau, 164.
 Ra'nub'kheperu, 134.
 Ra'nub'neferui, 230.
 Ra'nub'uaz, 230.
 Ra'peh'nub, 230.
 Ra'ra'neb'zefau, 227.
 Ra'sa, 246.
 Ra'sahu, 71.
 Ra'se'ankh....., 227.
 Ra'se'ankh'ab, xxv, 206, 207,
 229.
 Ra'se'ankh'ka, 141.
 Ra'se'ankh'n, 206.
 Ra'sebek'hotep, 206, 208.
 Ra'sebek'ka, 37, 65.
 Ra'sebek'neferu, 197.
 Ra'se'beq'ka, 245.
 Ra'se'heb, 227.
 Ra'se'hotep'ab, 148, 206, 208.
 Ra'se'kha'n, 109, 116.
 Ra'sekhem....., 227.
 Ra'sekhem'ka, xxv, 206, 207.
 Ra'sekhem'khu't'ai, 206, 207,
 229.
 Ra'sekhem'men't'ai, xxvi.
 Ra(?)sekhem'nefer'hotep, xxvii.
 Ra'sekhem'nefer'khau, 225.
 Ra'sekhem's'shedti't'ai, 223.
 Ra'sekhem'se'uaz't'ai, 206, 210,
 229.
 Ra'sekhem'uah'ka, 246.
 Ra'sekhem'uaz'khau, 222, 230.
 Ra'se'kheper'en, 227.
 Ra'se'men'ka, 206, 227.
 Ra'se'menk'ka, 206, 209.
 Ra'se'men....., 227.
 Ra'senb'ka, 227.
 Ra'se'nefer, xxviii.
 Ra'se'nefer'ka, 227, 229, 230.
 Ra'seshes'her'her'maat, 127.
 Ra'seshes'kaAmenemhat-senb f
 xxv.
 Ra'ses'nes'up'maat, 129.
 Ra'se'ner'user't'ai, 229.
 Ra'se'nub, 230.
 Ra'se'pehti, 230.
 Ra'se'uah'en, 230.

- Ra'se'uaz'en, xxviii, 229, 230.
 Ra'se'uaz'ka, 206.
 Ra'se'user....., 227.
 Ra'se'user'en, 118.
 Ra'se'zefa'ab, 206.
 Ra'shepses'ka, 74.
 Ra'uah'ab, xxvii, 206, 219.
 Ra'uah'ka, Khety, K., xxi.
 Ra'uben, 206, 227.
 Ra'user....., 228.
 Ra'user.....ra, 206.
 Ra'user'ka, 88.
-
- Ra, descent from, 69.
 Ra, obelisks of, 65, 71.
 Ra'ankh'ema, pr., 75, 78.
 Ra'en'kau, pr., 71, 75.
 Ra-en-user, pr., xix.
 Ra'hent, pr., 84, 88.
 Ra'hotep (IVth dyn.), 35.
 Ra'ka'pu, pr., 79.
 Ra'nefer'ab, pr., 42.
 Races, 3, 4.
 Ramessu II, K., list of kings
 by, 10.
 References, v, xv.
 Restoration of pyramids, theory,
 58.
 " of scarabs, 69.
 Rhatoises, K., 37.
 Riqqeh, 77.
 Ro, K., 3, 6.
- SABU, pr., 84, 87.
 Sahu, K., 36.
 Sahura, K., xviii, 13, 68, 71.
 Sakha, 231.
 Sakhebu, 70.
 Saqqara, list of, 10. (See
 Pyramids.)
 Salatis, K., 234, 236.
 Sanehat, adventures of, 153.
 Sa-nekht, K., 29-30.
 Sankh'ka'ra, K., 124, 141.
 Sat'hathor, 177.
 Sati (Asiatics), 152.
 Scarabs, 36*.
 " restored, 62.
 Schäfer, Dr., cited, 12.
 Scribes, 31*.
- Sculpture, 27*, 35, 35*.
 Search for stone, 151.
 Sebek'em'heb, 218.
 Sebek'em'saf I, K., xxvii, 222.
 Sebek'em'sauf II, K., xxvii,
 223.
 Sebek'hotep I, K., 206, 209.
 " II, K., xxvi, 206,
 210.
 " III, K., xxvii, 206,
 215.
 " IV, K., 206, 218.
 " V, K., 290, 219.
 " VI, K., 206, 220.
 Sebek'ka'ra, K., 65.
 Sebek'nekht, xxvii.
 Sebek'neferu, Q., 145, 187, 195,
 197.
 Seberkheres, K., 37.
 Sed festivals, xviii, xx, 93, 131,
 251.
 Seden'maat, pr., 73, 75, 76.
 Se'hotep'ab'ra, K., 148.
 Seka, K., 12.
 Seker'nefer'ka, K., 24, 27-28.
 Sekhem-ab, K., 25*, 26.
 Sekru-neferka, K., 23*.
 Semempses, K., 10.
 Sem'en'ptah, K., 10.
 Semken, xxi.
 Sem'nefer, 74, 75; pr., 78, 79.
 Semneh and Kummeh, 181,
 193.
 Sen'amen, 75.
 Senb, 211.
 Senbef, pr., 31*.
 Senb'maiu, K., 246.
 Senda, K., 23*, 24, 26, 26*.
 Seneferu, K. (IIIrd dyn.), 13.
 Sennu'ankh, pr., 71, 72.
 Sent, Q., 144.
 Sent's'senb, 176.
 Sen-usert, xxiii.
 Sesa, pr., 91, 102.
 Sesokhris, K., 23*, 24, 28, 29*.
 Set....., K., 228.
 Sethenes, K., 23*, 24.
 Set'hetu, K., 206.
 Sethos, K., 236.
 Sethu (Upper E. Nubia), 99.

- Sety I, compiled history, 27.
 „ „ K., table of kings in
 temple of, 1.
 Se' user'en'ra, K., 118.
 Sezes, K., 23*, 29, 32.
 Shaaru, K., 37, 37*.
 Shat, 163.
 Shemra, 25*.
 Shemsu, K., 206, 221.
 Shemyk, 163.
 Shens, xxi.
 Shepses'kaf, K., xviii, 13, 37,
 64.
 Shepses'kaf'ankh, pr., 42, 72,
 73.
 Shepses'ka'ra, K., 68, 74.
 Shera, pr., 26*.
 Shert'sat, Q., 144.
 Shesha, pr., 91.
 Shut er regal, tablets, 139, 142.
 Sifouris, K., 23*, 24, 29, 29*.
 Sinai tablets, 33*, 43, 71, 78, 80,
 92, 102, 158, 165, 189, 196.
 Sirius cycle, 249.
 „ festivals, 251.
 S'kha'n'ra, K., 109, 116.
 Sma, K., 3, 9, 14.
 Snaa'ab, K., 226.
 S'nefer'ka, K., 108, 109.
 Sneferu, K., xvii, 23*, 24, 29,
 29*, 32-35*, 37*.
 S'neferu'nefer, pr., 78, 79.
 S'nezem'ab, pr., 71, 73, 74, 75,
 76, 84.
 S'nezem'ab'antha, pr., 42.
 Soris, K., 37, 37*.
 Soufis, K., 23*, 24, 29, 31*.
 Sothis cycle, 249.
 „ festival, 251.
 Sphinx of Gizeh, 51.
 „ in Louvre, 92.
 Stele of 400 years, 244.
 Stone buildings, 35*, 36.
 Sufis, K., 37.
 Suhtes, K., 74.
 Sunu....., K., 228.

 TABLET of 400 years, 244.
 „ of Sphinx, so-called, 44.
 Tahuti, K., xxvi.

 Tahutmes III, list of, 11, 27.
 „ „ date of, xxviii,
 250.
 IV, 52.
 Tau, K., 12.
 Tefaba, 115.
 Tehute'nekht, xx, 93.
 Temehu (Oasis), 94, 99, 153.
 Temple of Gizeh, 48.
 „ of Illahun, 171.
 „ of Medum, 34.
 Tererel or Tereru, K., 108.
 Teta, K. (Athisis), 10, 17, 23*.
 „ VIth dyn.), xix, 86,
 87.
 Tetu, pr., 138.
 Thamfthis, K., 37, 37*.
 Thenta, pr., 33*, 42.
 Thenu'si'hor'nez'her'tef, K.,
 xxv.
 Thesh, K., 12.
 Theta, 92.
 „ pr., 53.
 Thunury, list of, 23*.
 Thuthu, 79.
 Thy, pr., 73, 76.
 Tias, K., 23*, 24.
 Tombs, plundering of, 5, 224.
 Tosertasis, 23*, 29, 29*.
 Tosorthros, K., 23*, 29, 29*,
 31*.
 Town of Kahun, 171.
 Transliteration, xvi.
 Tumen, Q., 141.
 Turin papyrus, xxvi, 11, 23*,
 24, 84, 108, 110, 201-205, 221.
 Turis, K., 23*, 29, 31*.

 UASH, pr., 53.
 Uaz-and, K., 12.
 Uazed, K., 109, 121.
 Uaz'neferui, K., 230.
 Uaz'nes, K., 23*, 24, 25*, 26.
 Uenefes, K., 10, 19*.
 Uha, pr., 92.
 Una, pr., 91, 98.
 „ inscription of, xx, 94.
 Unas, K., xix, 68, 82.
 Up'uat'em'saf, K., 225.
 Ur....., K., 206.

- Urarna, pr., xvii, 71.
 Ur'khuu, pr., 55, 73.
 Usafaidos, K., 10, 20*.
 User'en'ra, K., 68, 75.
 User'ka'f, K., xviii, 13, 68, 70.
 User'ka'ra, K., xxvii, 86, 88.
 User'tesen I, K., xxi-xxiii, 145, 156.
 „ II, K., 145, 168.
 „ „ K., statue of, 31*.
 „ III, K., xxiii, 145, 176.
 User'tesen-anh, Q., xxii.
 Uta, pr., 55.
 WAWAT (Lower E. Nubia), 94, 152.
 Weight, earliest, 46.
 „ of Hormera, 164.
 Westcar papyrus, 69.
- Writing, continuous, earliest known hieroglyphs for, 15.
 „ degraded form of, 23.
 XOIS, 230.
 YA'QEB'HER, K., xxi, 109, 122.
 Ykb (Yahub), K., xx.
 ZAU, pr., 95, 102.
 Zauta, pr., 91, 98, 102.
 Zautaker, 151.
 Zazati, K., 23*.
 Zazay, K., 23*, 24, 29, 29*.
 Zefa....., K., 23*.
 Zer-ta, K., 10, 16-18, 23.
 Zeser, K., 3, 6, 23*, 30*.
 Zesera, K., 23*, 24, 29, 29*, 30*.
 Zeserteta, K., 23*, 29, 29*, 32.
 Zeserti, K., 23*.
 Zet-ath, 10, 18, 18*.

A CATALOGUE OF BOOKS PUBLISHED BY METHUEN AND COMPANY: LONDON 36 ESSEX STREET W.C.

CONTENTS

	PAGE		PAGE
General Literature,	2-20	Little Galleries,	27
Ancient Cities,	20	Little Guides,	27
Antiquary's Books,	20	Little Library,	27
Arden Shakespeares,	20	Little Quarto Shakespeare,	29
Beginner's Books,	21	Miniature Library,	29
Business Books,	21	Oxford Biographies,	29
Byzantine Texts,	21	School Examination Series,	29
Churchman's Bible,	22	School Histories,	29
Churchman's Library,	22	Textbooks of Science,	29
Classical Translations,	22	Simplified French Texts,	29
Classics of Art,	23	Standard Library,	29
Commercial Series,	23	Textbooks of Technology,	29
Connoisseur's Library,	23	Handbooks of Theology,	29
Library of Devotion,	23	Westminster Commentaries,	29
Illustrated Pocket Library of	24	Fiction,	29
Plain and Coloured Books,	24	The Shilling Novels,	29
Paper Examination Series,	25	Books for Boys and Girls,	29
Paper School Books,	25	Novels of Alexander Dumas,	29
Library of Religion,	25	Methuen's Sixpenny Books,	29
Paper Books on Art,	25		

NOVEMBER 1907

A CATALOGUE OF
MESSRS. METHUEN'S
 PUBLICATIONS

Colonial Editions are published of all Messrs. METHUEN'S Novels issued at a price above 2s. 6d., and similar editions are published of some works of General Literature. These are marked in the Catalogue. Colonial editions are only for circulation in the British Colonies and India.

I.P.L. represents Illustrated Pocket Library.

PART I.—GENERAL LITERATURE

- Abbott (J. H. M.)**, Author of 'Tommy Cornstalk.' **AN OUTLANDER IN ENGLAND: BEING SOME IMPRESSIONS OF AN AUSTRALIAN ABROAD.** *Second Edition.* Cr. 8vo. 6s.
 A Colonial Edition is also published.
- Acetos (M. J.)**. See Junior School Books.
- Adams (Frank)**, JACK SPRATT. With 24 Coloured Pictures. *Super Royal 16mo.* 2s.
- Adeney (W. F.)**, M.A. See Bennett and Adeney.
- Æschylus**. See Classical Translations.
- Æsop**. See I.P.L.
- Ainsworth (W. Harrison)**. See I.P.L.
- Alderson (J. P.)**, MR. ASQUITH. With Portraits and Illustrations. *Demy 8vo.* 7s. 6d. net.
- Aldis (Janet)**, MADAME GEOFFRIN, HER SALON, AND HER TIMES. With many Portraits and Illustrations. *Second Edition.* *Demy 8vo.* 10s. 6d. net.
 A Colonial Edition is also published.
- Alexander (William)**, D.D., Archbishop of Armagh. **THOUGHTS AND COUNSELS OF MANY YEARS.** *Demy 16mo.* 2s. 6d.
- Alken (Henry)**, **THE NATIONAL SPORTS OF GREAT BRITAIN.** With descriptions in English and French. With 51 Coloured Plates. *Royal Folio.* *Five Guineas net.* The Plates can be had separately in a Portfolio. *£3, 3s. net.*
 See also I.P.L.
- Allen (C. C.)** See Textbooks of Technology.
- Allen (Jessie)**. See Little Books on Art.
- Allen (J. Romilly)**, F.S.A. See Antiquary's Books.
- Almack (E.)**. See Little Books on Art.
- Amherst (Lady)**, **A SKETCH OF EGYPTIAN HISTORY FROM THE EARLIEST TIMES TO THE PRESENT DAY.** With many Illustrations. *Demy 8vo.* 7s. 6d. net.
- Anderson (F. M.)**, **THE STORY OF THE BRITISH EMPIRE FOR CHILDREN.** With many Illustrations. Cr. 8vo. 2s.
- Anderson (J. G.)**, B.A., Examiner to London University, **NOUVELLE GRAMMAIRE FRANÇAISE.** Cr. 8vo. 2s.
- EXERCICES DE GRAMMAIRE FRANÇAISE.** Cr. 8vo. 1s. 6d.
- Andrewes (Bishop)**, **PRECES PRIVATÆ.** Edited, with Notes, by F. E. BRIGHTMAN, M.A., of Pusey House, Oxford. Cr. 8vo. 6s.
- Anglo-Australian.** **AFTER-GLOW MEMORIES.** Cr. 8vo. 6s.
 A Colonial Edition is also published.
- Anon.** **FELISSA; OR, THE LIFE AND OPINIONS OF A KITTEN OF SENTIMENT.** With 12 Coloured Plates. *Post 16mo.* 2s. 6d. net.
- Aristotle.** **THE NICOMACHEAN ETHICS.** Edited, with an Introduction and Notes, by JOHN BURNET, M.A., Professor of Greek at St. Andrews. *Cheaper issue.* *Demy 8vo.* 10s. 6d. net.
- Atkins (H. G.)**. See Oxford Biographies.
- Atkinson (C. M.)**, **JEREMY BENTHAM.** *Demy 8vo.* 5s. net.
- Atkinson (T. D.)**, **A SHORT HISTORY OF ENGLISH ARCHITECTURE.** With over 200 Illustrations. *Second Edition.* *Fcap. 8vo.* 3s. 6d. net.
- A GLOSSARY OF TERMS USED IN ENGLISH ARCHITECTURE.** Illustrated. *Second Ed.* *Fcap. 8vo.* 3s. 6d. net.
- Auden (T.)**, M.A., F.S.A. See Ancient Cities.
- Aurelius (Marcus) and Epictetus.** **WORDS OF THE ANCIENT WISE:** Thoughts from. Edited by W. H. D. ROUSE, M.A., Litt.D. *Fcap. 8vo.* 3s. 6d. net. See also Standard Library.
- Austen (Jane)**. See Little Library and Standard Library.
- Bacon (Francis)**. See Little Library and Standard Library.
- Baden-Powell (R. S. S.)**, Major-General. **THE DOWNFALL OF, PREMPEP A** Diary of Life in Ashanti 1895. Illustrated. *Third Edition.* *Large Cr. 8vo.* 6s.
 A Colonial Edition is also published.

- THE MATABELE CAMPAIGN, 1896.** With nearly 100 Illustrations. *Fourth Edition. Large Cr. 8vo. 6s.*
A Colonial Edition is also published.
- Bailey (J. C.), M.A.** See Cowper.
- Baker (W. G.), M.A.** See Junior Examination Series.
- Baker (Julian L.), F.I.C., F.C.S.** See Books on Business.
- Balfour (Graham).** THE LIFE OF ROBERT LOUIS STEVENSON. *Third and Cheaper Edition, Revised. Cr. 8vo. 6s.*
A Colonial Edition is also published.
- Ballard (A.), B.A., LL.B.** See Antiquary's Books.
- Bally (S. E.).** See Commercial Series.
- Banks (Elizabeth L.).** THE AUTOBIOGRAPHY OF A 'NEWSPAPER GIRL.' *Second Edition. Cr. 8vo. 6s.*
A Colonial Edition is also published.
- Barham (R. H.).** See Little Library.
- Baring (The Hon. Maurice), WITH THE RUSSIANS IN MANCHURIA.** *Third Edition. Demy 8vo. 7s. 6d. net.*
A Colonial Edition is also published.
- A YEAR IN RUSSIA.** *Second Edition. Demy 8vo. 7s. 6d.*
- Baring-Gould (S.).** THE LIFE OF NAPOLEON BONAPARTE. With over 150 Illustrations in the Text, and a Photogravure Frontispiece. *Royal 8vo. 10s. 6d. net.*
- THE TRAGEDY OF THE CÆSARS.** With numerous Illustrations from Busts, Gems, Cameos, etc. *Sixth Edition. Royal 8vo. 10s. 6d. net.*
- A BOOK OF FAIRY TALES.** With numerous Illustrations by A. J. GASKIN. *Third Edition. Cr. 8vo. Buckram. 6s.*
- OLD ENGLISH FAIRY TALES.** With numerous Illustrations by F. D. BEDFORD. *Third Edition. Cr. 8vo. Buckram. 6s.*
- THE VICAR OF MORWENSTOW.** Revised Edition. With a Portrait. *Third Edition. Cr. 8vo. 3s. 6d.*
- A BOOK OF DARTMOOR: A Descriptive and Historical Sketch.** With Plans and numerous Illustrations. *Second Edition. Cr. 8vo. 6s.*
- A BOOK OF DEVON.** Illustrated. *Second Edition. Cr. 8vo. 6s.*
- A BOOK OF CORNWALL.** Illustrated. *Second Edition. Cr. 8vo. 6s.*
- A BOOK OF NORTH WALES.** Illustrated. *Cr. 8vo. 6s.*
- A BOOK OF SOUTH WALES.** Illustrated. *Cr. 8vo. 6s.*
- A BOOK OF BRITANNY.** Illustrated. *Cr. 8vo. 6s.*
- A BOOK OF THE RIVIERA.** Illustrated. *Cr. 8vo. 6s.*
A Colonial Edition is also published.
- A BOOK OF THE RHINE: From Cleve to Mainz.** Illustrated. *Second Edition. Crown 8vo. 6s.*
A Colonial Edition is also published.
- A BOOK OF THE PYRENEES.** With 24 Illustrations. *Crown 8vo. 6s.*
A Colonial Edition is also published.
- A BOOK OF GHOSTS.** With 8 Illustrations by D. MURRAY SMITH. *Second Edition. Cr. 8vo. 6s.*
- OLD COUNTRY LIFE.** With 67 Illustrations. *Fifth Edition. Large Cr. 8vo. 6s.*
- A GARLAND OF COUNTRY SONG: English Folk Songs with their Traditional Melodies.** Collected and arranged by S. BARING-GOULD and H. F. SHEPPARD. *Demy 4to. 6s.*
- SONGS OF THE WEST: Folk Songs of Devon and Cornwall.** Collected from the Mouths of the People. By S. BARING-GOULD, M.A., and H. FLEETWOOD SHEPPARD, M.A. New and Revised Edition, under the musical editorship of CECIL J. SHARP, Principal of the Hampstead Conservatoire. *Large Imperial 8vo. 5s. net.*
- A BOOK OF NURSERY SONGS AND RHYMES.** Edited by S. BARING-GOULD, and Illustrated by the Birmingham Art School. *A New Edition. Long Cr. 8vo. 2s. 6d. net.*
- STRANGE SURVIVALS AND SUPERSTITIONS.** *Third Edition. Cr. 8vo. 2s. 6d. net.*
- YORKSHIRE ODDITIES AND STRANGE EVENTS.** *New and Revised Edition. Cr. 8vo. 2s. 6d. net.*
See also Little Guides.
- Barker (Aldred F.).** See Textbooks of Technology.
- Barker (E.), M.A.** (Late Fellow of Merton College, Oxford). THE POLITICAL THOUGHT OF PLATO AND ARISTOTLE. *Demy 8vo. 10s. 6d. net.*
- Barnes (W. E.), D.D.** See Churchman's Bible.
- Barnett (Mrs. P. A.).** See Little Library.
- Baron (R. R. N.), M.A.** FRENCH PROSE COMPOSITION. *Second Edition. Cr. 8vo. 2s. 6d. Key. 3s. net.*
See also Junior School Books.
- Barron (H. M.), M.A.,** Wadham College, Oxford. TEXTS FOR SERMONS. With a Preface by Canon SCOTT HOLLAND. *Cr. 8vo. 3s. 6d.*
- Bartholomew (J. G.), F.R.S.E.** See C. G. Robertson.
- Bastable (C. F.), M.A.** THE COMMERCE OF NATIONS. *Fourth Ed. Cr. 8vo. 2s. 6d.*
- Bastian (H. Charlton), M.D., F.R.S.** THE EVOLUTION OF LIFE. Illustrated. *Demy 8vo. 7s. 6d. net.*
- Batson (Mrs. Stephen).** A CONCISE HANDBOOK OF GARDEN FLOWERS. *Fcap. 8vo. 3s. 6d.*
- Batten (Loring W.), Ph.D., S.T.D.** THE HEBREW PROPHECY. *Cr. 8vo. 3s. 6d. net.*
- Bayley (R. Child).** THE COMPLETE PHOTOGRAPHER. With over 100 Illustrations. *Second Edition. Demy 8vo. 10s. 6d. net.*
- Beard (W. S.).** EASY EXERCISES IN ALGEBRA. *Cr. 8vo. 1s. 6d.* See Junior Examination Series and Beginner's Books.

- Beckford (Peter).** THOUGHTS ON HUNTING. Edited by J. OTHO PAGET, and Illustrated by G. H. JALLAND. *Second Edition.* Demy 8vo. 6s.
- Beckford (William).** See Little Library.
- Beeching (H. C.), M.A.,** Canon of Westminster. See Library of Devotion.
- Begbie (Harold).** MASTER WORKERS. Illustrated. Demy 8vo. 7s. 6d. net.
- Behmen (Jacob).** DIALOGUES ON THE SUPERSENSUAL LIFE. Edited by BERNARD HOLLAND. Fcap. 8vo. 3s. 6d.
- Bell (Mrs. A.).** THE SKIRTS OF THE GREAT CITY. *Second Ed.* Cr. 8vo. 6s.
- Belloz (Hilaire), M.P.** PARIS. With Maps and Illustrations. *Second Edition, Revised.* Cr. 8vo. 6s.
- HILLS AND THE SEA. *Second Edition.* Crown 8vo. 6s.**
- Bellot (H. H. L.), M.A.** THE INNER AND MIDDLE TEMPLE. With numerous Illustrations. Crown 8vo. 6s. net.
- Bennett (W. H.), M.A.** A PRIMER OF THE BIBLE. *Fourth Ed.* Cr. 8vo. 2s. 6d.
- Bennett (W. H.) and Adeney (W. F.).** A BIBLICAL INTRODUCTION. *Fourth Edition.* Cr. 8vo. 7s. 6d.
- Benson (Archbishop) GOD'S BOARD:** Communion Addresses. Fcap. 8vo. 3s. 6d. net.
- Benson (A. C.), M.A.** See Oxford Biographies.
- Benson (R. M.).** THE WAY OF HOLINESS: a Devotional Commentary on the 119th Psalm. Cr. 8vo. 5s.
- Bernard (E. R.), M.A.,** Canon of Salisbury. THE ENGLISH SUNDAY. Fcap. 8vo. 1s. 6d.
- Bertouch (Baroness de).** THE LIFE OF FATHER IGNATIUS. Illustrated. Demy 8vo. 10s. 6d. net.
- Berucete (A. de).** See Classics of Art.
- Betham-Edwards (M.).** HOME LIFE IN FRANCE. Illustrated. *Fourth and Cheaper Edition.* Crown 8vo. 6s.
A Colonial Edition is also published.
- Bethune-Baker (J. F.), M.A.** See Handbooks of Theology.
- Bidez (M.).** See Byzantine Texts.
- Biggs (C. R. D.), D.D.** See Churchman's Bible.
- Bindley (T. Herbert), B.I.** THE OECUMENICAL DOCUMENTS OF THE FAITH. With Introductions and Notes. *Second Edition.* Cr. 8vo. 6s. net.
- Binns (H. B.).** THE LIFE OF WALT WHITMAN. Illustrated. Demy 8vo. 10s. 6d. net.
A Colonial Edition is also published.
- Binyon (Lawrence).** THE DEATH OF ADAM, AND OTHER POEMS. Cr. 8vo. 3s. 6d. net.
See also W. Blake.
- Birnstingl (Ethel).** See Little Books on Art.
- Blair (Robert).** See I.P.L.
- Blake (William).** THE LETTERS OF WILLIAM BLAKE, TOGETHER WITH A LIFE BY FREDERICK TATHAM. Edited from the Original Manuscripts, with an Introduction and Notes, by ARCHIBALD G. B. RUSSELL. With 12 Illustrations. Demy 8vo. 7s. 6d. net.
- ILLUSTRATIONS OF THE BOOK OF JOB.** With a General Introduction by LAWRENCE BINYON. Quarto. 21s. net.
See also I.P.L. and Little Library.
- Blaxland (B.), M.A.** See Library of Devotion.
- Bloom (J. Harvey), M.A.** SHAKESPEARE'S GARDEN. Illustrated. Fcap. 8vo. 3s. 6d.; leather, 4s. 6d. net.
See also Antiquary's Books.
- Blouet (Henri).** See Beginner's Books.
- Boardman (T. H.), M.A.** See Textbooks of Science.
- Bodley (J. E. C.),** Author of 'France.' THE CORONATION OF EDWARD VII. Demy 8vo. 21s. net. By Command of the King.
- Body (George), D.D.** THE SOUL'S PILGRIMAGE: Devotional Readings from his writings. Selected by J. H. BURN, B.D., F.R.S.E. Demy 16mo. 2s. 6d.
- Bona (Cardinal).** See Library of Devotion.
- Boon (F. C.).** See Commercial Series.
- Borrow (George).** See Little Library.
- Bos (J. Ritzema).** AGRICULTURAL ZOOLOGY. Translated by J. R. AINSWORTH DAVIS, M.A. With 155 Illustrations. Cr. 8vo. *Third Edition.* 3s. 6d.
- Botting (C. G.), B.A.** EASY GREEK EXERCISES. Cr. 8vo. 2s. See also Junior Examination Series.
- Boulting (W.) TASSO AND HIS TIMES.** With 24 Illustrations. Demy 8vo. 10s. 6d. net.
- Boulton (E. S.), M.A.** GEOMETRY ON MODERN LINES. Cr. 8vo. 2s.
- Boulton (William B.), THOMAS GAINSBOROUGH** With 40 Illustrations. Demy 8vo. 7s. 6d. net.
- SIR JOSHUA REYNOLDS, P.R.A.** With 49 Illustrations. Demy 8vo. 7s. 6d. net.
- Bowden (E. M.).** THE IMITATION OF BUDDHA: Being Quotations from Buddhist Literature for each Day in the Year. *Fifth Edition.* Cr. 16mo. 2s. 6d.
- Boyd-Carpenter (Margaret).** THE CHILD IN ART. Illustrated. *Second Edition.* Large Crown 8vo. 6s.
- Boyle (W.).** CHRISTMAS AT THE ZOO. With Verses by W. BOYLE and 24 Coloured Pictures by H. B. NEILSON. *Super Royal 16mo.* 2s.
- Brabant (F. G.), M.A.** See Little Guides.
- Bradley (A. G.)** ROUND ABOUT WILTSHIRE. With 30 Illustrations of which 14 are in colour by T. C. GOTCH. *Second Ed.* Cr. 8vo. 6s.
- Bradley (J. W.).** See Little Books on Art.
- Braid (James) and Others.** GREAT GOLFERS IN THE MAKING. By Thirty-Four Famous Players. Edited, with an Introduction, by HENRY LEACH. With 34 Portraits. Demy 8vo. 7s. 6d. net.
A Colonial Edition is also published.

- Brailsford (H. N.).** MACEDONIA: ITS RACES AND ITS FUTURE. Illustrated. *Demy 8vo. 12s. 6d. net.*
- Brodrick (Mary) and Morton (Anderson).** A CONCISE HANDBOOK OF EGYPTIAN ARCHAEOLOGY. Illustrated. *Cr. 8vo. 3s. 6d.*
- Brooks (E. E.),** B.Sc. See Textbooks of Technology.
- Brooks (E. W.).** See Byzantine Texts.
- Brown (P. H.),** LL.D., Fraser Professor of Ancient (Scottish) History at the University of Edinburgh. SCOTLAND IN THE TIME OF QUEEN MARY. *Demy 8vo. 7s. 6d. net.*
- Brown (S. E.),** M.A., Camb., B.A., B.Sc., London; Senior Science Master at Uppingham School. A PRACTICAL CHEMISTRY NOTE-BOOK FOR MATRICULATION AND ARMY CANDIDATES: EASIER EXPERIMENTS ON THE COMMONER SUBSTANCES. *Cr. 4to. 1s. 6d. net.*
- Browne (Sir Thomas).** See Standard Library.
- Brownell (C. L.).** THE HEART OF JAPAN. Illustrated. *Third Edition. Cr. 8vo. 6s.; also Demy 8vo. 6d.*
- Browning (Robert).** See Little Library.
- Buckland (Francis T.).** CURIOSITIES OF NATURAL HISTORY. Illustrated by H. B. NEILSON. *Cr. 8vo. 3s. 6d.*
- Buckton (A. M.).** THE BURDEN OF ENGELA: a Ballad-Epic. *Second Edition. Cr. 8vo. 3s. 6d. net.*
- KINGS IN BABYLON.** A Drama. *Crown 8vo. 1s. net.*
- EAGER HEART: A Mystery Play.** *Fifth Edition. Cr. 8vo. 1s. net.*
- Budge (E. A. Wallis).** THE GODS OF THE EGYPTIANS. With over 100 Coloured Plates and many Illustrations. *Two Volumes. Royal 8vo. £3. 3s. net.*
- Bulst (H. Massac).** THE MOTOR YEAR BOOK AND AUTOMOBILISTS' ANNUAL FOR 1906. *Demy 8vo. 7s. 6d. net.*
- Bull (Paul),** Army Chaplain. GOD AND OUR SOLDIERS. *Second Edition. Cr. 8vo. 6s.*
- Bulley (Miss).** See Lady Dilke.
- Bunyan (John).** THE PILGRIM'S PROGRESS. Edited, with an Introduction, by C. H. FIRTH, M.A. With 39 Illustrations by R. ANNING BELL. *Cr. 8vo. 6s.*
See also Library of Devotion and Standard Library.
- Burch (G. J.),** M.A., F.R.S. A MANUAL OF ELECTRICAL SCIENCE. Illustrated. *Cr. 8vo. 3s.*
- Burgess (Gelett).** GOOPS AND HOW TO BE THEM. Illustrated. *Small 4to. 6s.*
- Burke (Edmund).** See Standard Library.
- Burn (A. E.),** D.D., Rector of Handsworth and Prebendary of Lichfield.
See Handbooks of Theology.
- Burn (J. H.),** B.D. THE CHURCHMAN'S TREASURY OF SONG. Selected and Edited by. *Fcap 8vo. 3s. 6d. net.* See also Library of Devotion.
- Burnand (Sir F. C.).** RECORDS AND REMINISCENCES. With a Portrait by H. v. HERKOMER. *Cr. 8vo. Fourth and Cheaper Edition. 6s.*
A Colonial Edition is also published.
- Burns (Robert),** THE POEMS OF. Edited by ANDREW LANG and W. A. CRAIGIE. With Portrait. *Third Edition. Demy 8vo, gilt top. 6s.*
- Burnside (W. F.),** M.A. OLD TESTAMENT HISTORY FOR USE IN SCHOOLS. *Third Edition. Cr. 8vo. 3s. 6d.*
- Burton (Alfred).** See I.P.L.
- Bussell (F. W.),** D.D., Fellow and Vice Principal of Brasenose College, Oxford. CHRISTIAN THEOLOGY AND SOCIAL PROGRESS: The Bampton Lectures for 1905. *Demy 8vo 10s. 6d. net.*
- Butler (Joseph).** See Standard Library.
- Caldecott (Alfred),** D.D. See Handbooks of Theology.
- Calderwood (D. S.),** Headmaster of the Normal School, Edinburgh. TEST CARDS IN EUCLID AND ALGEBRA. In three packets of 40, with Answers. 1s. each. Or in three Books, price 2d., 2d., and 3d.
- Cambridge (Ada) [Mrs. Cross].** THIRTY YEARS IN AUSTRALIA. *Demy 8vo. 7s. 6d.*
- Canning (George).** See Little Library.
- Capey (E. F. H.).** See Oxford Biographies.
- Careless (John).** See I.P.L.
- Carlyle (Thomas).** THE FRENCH REVOLUTION. Edited by C. R. L. FLETCHER, Fellow of Magdalen College, Oxford. *Three Volumes. Cr. 8vo. 18s.*
- THE LIFE AND LETTERS OF OLIVER CROMWELL.** With an Introduction by C. H. FIRTH, M.A., and Notes and Appendices by Mrs. S. C. LOMAS. *Three Volumes. Demy 8vo. 18s. net.*
- Carlyle (R. M. and A. J.),** M.A. See Leaders of Religion.
- Channer (C. C.) and Roberts (M. E.).** LACEMAKING IN THE MIDLANDS, PAST AND PRESENT. With 16 full-page Illustrations. *Cr. 8vo. 2s. 6d.*
- Chapman (S. J.).** See Books on Business.
- Chatterton (Thomas).** See Standard Library.
- Chesterfield (Lord),** THE LETTERS OF, TO HIS SON. Edited, with an Introduction by C. STRACHEY, and Notes by A. CALTHROP. *Two Volumes. Cr. 8vo. 12s.*
- Chesterton (G. K.).** CHARLES DICKENS. With two Portraits in photogravure. *Fourth Edition. Demy 8vo. 7s. 6d. net.*
A Colonial Edition is also published.
- Child (Charles P.),** B.A., F.R.C.S. THE CONTROL OF A SCOURGE: OR, HOW CANCER IS CURABLE. *Demy 8vo. 7s. 6d. net.*

- Christian (F. W.).** THE CAROLINE ISLANDS. With many Illustrations and Maps. *Demy 8vo. 12s. 6d. net.*
- Cicero.** See Classical Translations.
- Clarke (F. A.), M.A.** See Leaders of Religion.
- Clausen (George), A.R.A., R.W.S.** AIMS AND IDEALS IN ART : Eight Lectures delivered to the Students of the Royal Academy of Arts. With 32 Illustrations. *Second Edition. Large Post 8vo. 5s. net. SIX LECTURES ON PAINTING. First Series. With 19 Illustrations. Third Edition, Large Post 8vo. 3s. 6d. net.*
- Cleather (A. L.).** See Wagner.
- Clinch (G.).** See Little Guides.
- Clough (W. T.).** See Junior School Books and Textbooks of Science.
- Clouston (T. S.), M.D., C.C.D., F.R.S.E.,** Lecturer on Mental Diseases in the University of Edinburgh. THE HYGIENE OF MIND. With 20 Illustrations. *Fourth Edition. Demy 8vo. 7s. 6d. net.*
- Coast (W. G.), B.A.** EXAMINATION PAPERS IN VERGIL. *Cr. 8vo. 2s.*
- Cobb (W. F.), M.A.** THE BOOK OF PSALMS : with a Commentary. *Demy 8vo. 10s. 6d. net.*
- Coleridge (S. T.).** POEMS OF. Selected and Arranged by ARTHUR SYMONS. With a photogravure Frontispiece. *Fcap. 8vo. 2s. 6d. net.*
- Collingwood (W. G.), M.A.** THE LIFE OF JOHN RUSKIN. With Portraits. *Sixth Edition. Cr. 8vo. 2s. 6d. net.*
- Collins (W. E.), M.A.** See Churchman's Library.
- Colonna.** HYPNEROTOMACHIA POLIPHILI UBI HUMANA OMNIA NON NISI SOMNIUM ESSE DOCET ATQUE OBITER PLURIMA SCITUM SANE QUAM DIGNA COMMEMORAT. An edition limited to 350 copies on handmade paper. *Folio. £3, 3s. net.*
- Combe (William).** See I.P.L.
- Conrad (Joseph).** THE MIRROR OF THE SEA: Memories and Impressions. *Third Edition. Cr. 8vo. 6s.*
- Cook (A. M.), M.A., and Marchant (C. E.), M.A.** PASSAGES FOR UNSEEN TRANSLATION. Selected from Greek and Latin Literature. *Third Ed. Cr. 8vo. 3s. 6d.*
- LATIN PASSAGES FOR UNSEEN TRANSLATION. Third Ed. Cr. 8vo. 1s. 6d.**
- Cooke-Taylor (R. W.).** THE FACTORY SYSTEM. *Cr. 8vo. 2s. 6d.*
- Corelli (Marie).** THE PASSING OF THE GREAT QUEEN. *Second Ed. Fcap. 4to. 1s.*
- A CHRISTMAS GREETING. Cr. 4to. 1s.**
- Corkran (Alice).** See Little Books on Art.
- Cotes (Everard).** SIGNS AND PORTENTS IN THE FAR EAST. With 24 Illustrations. *Second Edition. Demy 8vo. 7s. 6d. net.*
- Cotes (Rosemary).** DANTE'S GARDEN. With a Frontispiece. *Second Edition. Fcap. 8vo. 2s. 6d.; leather, 3s. 6d. net.*
- BIBLE FLOWERS.** With a Frontispiece and Plan. *Fcap. 8vo. 2s. 6d. net.*
- Cowley (Abraham).** See Little Library.
- Cowper (William).** THE POEMS OF. Edited with an Introduction and Notes by J. C. BAILEY, M.A. Illustrated, including two unpublished designs by WILLIAM BLAKE. *Demy 8vo. 10s. 6d. net.*
- Cox (J. Charles), LL.D., F.S.A.** See Little Guides, The Antiquary's Books, and Ancient Cities.
- Cox (Harold), B.A., M.P.** LAND NATIONALISATION AND LAND TAXATION. *Second Edition revised. Cr. 8vo. 3s. 6d. net.*
- Crabbe (George).** See Little Library.
- Craigie (W. A.).** A PRIMER OF BURNS. *Cr. 8vo. 2s. 6d.*
- Craik (Mrs.).** See Little Library.
- Crane (Capt. C. P.).** See Little Guides.
- Crane (Walter).** AN ARTIST'S REMINISCENCES. *Second Edition.*
- Crashaw (Richard).** See Little Library.
- Crawford (F. G.).** See Mary C. Danson.
- Crofts (T. R. N.), M.A.** See Simplified French Texts.
- Cross (J. A.), M.A.** THE FAITH OF THE BIBLE. *Fcap. 8vo. 2s. 6d. net.*
- Cruikshank (G.).** THE LOVING BAL-LAD OF LORD BATEMAN. With 11 Plates. *Cr. 16mo. 1s. 6d. net.*
- Cr. np (B.).** See Wagner.
- Cunliffe (Sir F. H. E.),** Fellow of All Souls' College, Oxford. THE HISTORY OF THE BOER WAR. With many Illustrations, Plans, and Portraits. *In 2 vols. Quarto. 15s. each.*
- Cunynghame (H. H.), C.B.** See Connoisseur's Library.
- Cutts (H. L.), D.D.** See Leaders of Religion.
- Daniell (G. W.), M.A.** See Leaders of Religion.
- Danson (Mary C.) and Crawford (F. G.).** FATHERS IN THE FAITH. *Fcap. 8vo. 1s. 6d.*
- Dante.** LA COMMEDIA DI DANTE. The Italian Text edited by PAGET TOYNBEE, M.A., D.Litt. *Cr. 8vo. 6s.*
- THE PURGATORIO OF DANTE.** Translated into Spenserian Prose by C. GORDON WRIGHT. With the Italian text. *Fcap. 8vo. 2s. 6d. net.*
- See also Paget Toynbee, Little Library, Standard Library, and Warren-Vernon.
- Darley (George).** See Little Library.
- D'Arcy (R. F.), M.A.** A NEW TRIGONOMETRY FOR BEGINNERS. With numerous diagrams. *Cr. 8vo. 2s. 6d.*
- Davenport (Cyril).** See Connoisseur's Library and Little Books on Art.
- Davey (Richard).** THE PAGEANT OF LONDON With 40 Illustrations in Colour by JOHN FULLEYLOVE, R.I. *In Two Volumes. Demy 8vo. 15s. net.*
- Davis (H. W. C.), M.A.,** Fellow and Tutor of Balliol College. Author of 'Charlemagne.' ENGLAND UNDER THE NORMANS AND ANGEVINS: 1066-1272. With Maps and Illustrations. *Demy 8vo. 10s. 6d. net.*
- Dawson (Nelson).** See Connoisseur's Library.

Dawson (Mrs. N.). See Little Books on Art.

Deane (A. C.). See Little Library.

Dearmer (Nabel). A CHILD'S LIFE OF CHRIST. With 8 Illustrations in Colour by E. KORTSCHEUR-BRICKDALE. *Large Cr. 8vo. 6s.*

Delbos (Leon). THE METRIC SYSTEM. *Cr. 8vo. 2s.*

Demosthenes. AGAINST CONON AND CALLICLES. Edited by F. DARWIN SWIFT, M.A. *Second Edition. Pcap. 8vo. 2s.*

Dickens (Charles). See Little Library, I.P.L., and Chesterton.

Dickinson (Emily). POEMS. *Cr. 8vo. 4s. 6d. net.*

Dickinson (G. L.), M.A., Fellow of King's College, Cambridge. THE GREEK VIEW OF LIFE. *Sixth Edition. Cr. 8vo. 2s. 6d.*

Dilke (Lady), Bulley (Miss), and Whitley (Miss). WOMEN'S WORK. *Cr. 8vo. 2s. 6d.*

Dillon (Edward). See Connoisseur's Library and Little Books on Art.

Ditchfield (P. H.), M.A., F.S.A. THE STORY OF OUR ENGLISH TOWNS. With an Introduction by AUGUSTUS JESSOP, D.D. *Second Edition. Cr. 8vo. 6s.*

OLD ENGLISH CUSTOMS: Extant at the Present Time. *Cr. 8vo. 6s.*

ENGLISH VILLAGES. Illustrated. *Second Edition. Cr. 8vo. 2s. 6d. net.*

THE PARISH CLERK. With 31 Illustrations. *Third Edition. Demy 8vo. 7s. 6d. net.*

Dixon (W. M.), M.A. A PRIMER OF TENNYSON. *Second Edition. Cr. 8vo. 2s. 6d.*

ENGLISH POETRY FROM BLAKE TO BROWNING. *Second Edition. Cr. 8vo. 2s. 6d.*

Doney (May). SONGS OF THE REAL. *Cr. 8vo. 3s. 6d. net.*

A volume of poems.

Douglas (James). THE MAN IN THE PULPIT. *Cr. 8vo. 2s. 6d. net.*

Dowden (J.), D.D., Lord Bishop of Edinburgh. See Churchman's Library.

Drage (G.). See Books on Business.

Driver (S. R.), D.D., D.C.L., Canon of Christ Church, Regius Professor of Hebrew in the University of Oxford. SERMONS ON SUBJECTS CONNECTED WITH THE OLD TESTAMENT. *Cr. 8vo. 6s.*

See also Westminster Commentaries.

Dry (Wakeling). See Little Guides.

Dryhurst (A. R.). See Little Books on Art.

Du Buisson (J. C.), M.A. See Churchman's Bible.

Duguld (Charles). See Books on Business.

Dumas (Alexander). MY MEMOIRS. Translated by E. M. WALLER. With Portraits. *In Six Volumes. Cr. 8vo. 6s. each.* Volume I.

Dunn (J. T.), D.Sc., and Mundella (V. A.). GENERAL ELEMENTARY SCIENCE. With 114 Illustrations. *Second Edition. Cr. 8vo. 3s. 6d.*

Dunstan (A. E.), R.Sc. See Junior School Books and Textbooks of Science.

Durham (The Earl of). A REPORT ON CANADA. With an Introductory Note. *Demy 8vo. 4s. 6d. net.*

Dutt (W. A.). THE NORFOLK BROADS. With coloured Illustrations by FRANK SOUTHGATE. *Cr. 8vo. 6s.*

WILD LIFE IN EAST ANGLIA. With 16 Illustrations in colour by FRANK SOUTHGATE, R.B.A. *Second Edition. Demy 8vo. 7s. 6d. net.*

See also Little Guides.

Earle (John), Bishop of Salisbury. MICRO-COSMOGRAPHIE, OR A PIECE OF THE WORLD DISCOVERED. *Post 16mo. 2s. net.*

Edmonds (Major J. E.). See W. B. Wood.

Edwards (Clement), M.P. RAILWAY NATIONALIZATION. *Second Edition Revised. Crown 8vo. 2s. 6d. net.*

Edwards (W. Douglas). See Commercial Series.

Egan (Pierce). See I.P.L.

Egerton (H. E.), M.A. A HISTORY OF BRITISH COLONIAL POLICY. New and Cheaper Issue. *Demy 8vo. 7s. 6d. net.* A Colonial Edition is also published.

Ellaby (C. G.). See Little Guides.

Ellerton (F. G.). See S. J. Stone.

Ellwood (Thomas), THE HISTORY OF THE LIFE OF. Edited by C. G. CRUMP, M.A. *Cr. 8vo. 6s.*

Epicteus. See Aurelius.

Erasmus. A Book called in Latin EN-CHIRIDION MILITIS CHRISTIANI, and in English the Manual of the Christian Knight.

From the edition printed by Wynken de Worde, 1533. *Pcap. 8vo. 3s. 6d. net.*

Fairbrother (W. H.), M.A. THE PHILOSOPHY OF T. H. GREEN. *Second Edition. Cr. 8vo. 3s. 6d.*

Farrer (Reginald). THE GARDEN OF ASIA. *Second Edition. Cr. 8vo. 6s.*

Fea (Allan). SOME BEAUTIES OF THE SEVENTEENTH CENTURY. With 82 Illustrations. *Second Edition. Demy 8vo. 12s. 6d. net.*

Ferrier (Susan). See Little Library.

Fidler (T. Claxton), M.Inst. C.E. See Books on Business.

Fielding (Henry). See Standard Library.

Finn (S. W.), M.A. See Junior Examination Series.

Firth (J. B.). See Little Guides.

Firth (C. H.), M.A. CROMWELL'S ARMY: A History of the English Soldier during the Civil Wars, the Commonwealth, and the Protectorate. *Cr. 8vo. 6s.*

- Fisher (G. W.), M.A.** ANNALS OF SHREWSBURY SCHOOL. Illustrated. *Demy 8vo.* 10s. 6d.
- FitzGerald (Edward).** THE RUBAIYAT OF OMAR KHAYYAM. Printed from the Fifth and last Edition. With a Commentary by Mrs. STEPHEN BATSON, and a Biography of Omar by E. D. ROSS. *Cr. 8vo.* 6s. See also Miniature Library.
- FitzGerald (H. P.).** A CONCISE HANDBOOK OF CLIMBERS, TWINERS, AND WALL SHRUBS. Illustrated. *Fcap. 8vo.* 3s. 6d. net.
- Fitzpatrick (S. A. O.).** See Ancient Cities.
- Flecker (W. H.), M.A., D.C.L.,** Headmaster of the Dean Close School, Cheltenham. THE STUDENT'S PRAYER BOOK. THE TEXT OF MORNING AND EVENING PRAYER AND LITANY. With an Introduction and Notes. *Cr. 8vo.* 2s. 6d.
- Flux (A. W.), M.A.,** William Dow Professor of Political Economy in McGill University, Montreal. ECONOMIC PRINCIPLES. *Demy 8vo.* 7s. 6d. net.
- Fortescue (Mrs. G.).** See Little Books on Art.
- Fraser (David).** A MODERN CAMPAIGN; OR, WAR AND WIRELESS TELEGRAPHY IN THE FAR EAST. Illustrated. *Cr. 8vo.* 6s.
A Colonial Edition is also published.
- Fraser (J. F.).** ROUND THE WORLD ON A WHEEL. With 100 Illustrations. *Fifth Edition Cr. 8vo.* 6s.
- French (W.), M.A.** See Textbooks of Science.
- Freudenreich (Ed. von).** DAIRY BACTERIOLOGY. A Short Manual for the Use of Students. Translated by J. R. AINSWORTH DAVIS, M.A. *Second Edition. Revised. Cr. 8vo.* 2s. 6d.
- Fulford (H. W.), M.A.** See Churchman's Bible.
- Gallaher (D.) and Stead (W. J.).** THE COMPLETE RUGBY FOOTBALLER, ON THE NEW ZEALAND SYSTEM. With an Account of the Tour of the New Zealanders in England. With 35 Illustrations. *Demy 8vo.* 10s. 6d. net.
- Gallchan (W. M.).** See Little Guides.
- Gambado (Geoffrey, Esq.).** See I.P.L.
- Gaskell (Mrs.).** See Little Library and Standard Library.
- Gasquet, the Right Rev. Abbot, O.S.B.** See Antiquary's Books.
- George (H. B.), M.A.,** Fellow of New College, Oxford. BATTLES OF ENGLISH HISTORY. With numerous Plans. *Fourth Edition.* Revised, with a new Chapter including the South African War. *Cr. 8vo.* 3s. 6d.
- A HISTORICAL GEOGRAPHY OF THE BRITISH EMPIRE.** *Second Edition. Cr. 8vo.* 3s. 6d.
- Gibbins (H. de B.), Litt.D., M.A.** INDUSTRY IN ENGLAND: HISTORICAL OUTLINES. With 5 Maps. *Fifth Edition. Demy 8vo.* 10s. 6d.
- THE INDUSTRIAL HISTORY OF ENGLAND.** *Thirteenth Edition.* Revised. With Maps and Plans. *Cr. 8vo.* 3s.
- ENGLISH SOCIAL REFORMERS.** *Second Edition. Cr. 8vo.* 2s. 6d.
See also Commercial Series and R. A. Hadfield.
- Gibbon (Edward).** THE DECLINE AND FALL OF THE ROMAN EMPIRE. Edited with Notes, Appendices, and Maps, by J. B. BURV, M.A., Litt.D., Regius Professor of Greek at Cambridge. *In Seven Volumes. Demy 8vo. Gilt top, 8s. 6d. each. Also, Cr. 8vo.* 6s. each.
- MEMOIRS OF MY LIFE AND WRITINGS.** Edited by G. BIRKBECK HILL, LL.D. *Cr. 8vo.* 6s.
See also Standard Library.
- Gibson (E. C. S.), D.D.,** Lord Bishop of Gloucester. See Westminster Commentaries, Handbooks of Theology, and Oxford Biographies.
- Gilbert (A. R.).** See Little Books on Art.
- Gloag (M. R.) and Wyatt (Kate M.).** A BOOK OF ENGLISH GARDENS. With 24 Illustrations in Colour. *Demy 8vo.* 10s. 6d. net.
- Godfrey (Elizabeth).** A BOOK OF REMEMBRANCE. Edited by. *Fcap. 8vo.* 2s. 6d. net.
- Godley (A. D.), M.A.,** Fellow of Magdalen College, Oxford. LYRA FRIVOLA. *Third Edition. Fcap. 8vo.* 2s. 6d.
- VERSES TO ORDER.** *Second Edition. Fcap. 8vo.* 2s. 6d.
- SECOND STRINGS.** *Fcap. 8vo.* 2s. 6d.
- Goldsmith (Oliver).** THE VICAR OF WAKEFIELD. *Fcap. 32mo.* With 10 Plates in Photogravure by Tony Johannot. *Leather, 2s. 6d. net.*
See also I.P.L. and Standard Library.
- Goodrich-Freer (A.).** IN A SYRIAN SADDLE. *Demy 8vo.* 7s. 6d. net.
A Colonial Edition is also published.
- Gorst (Rt. Hon. Sir John).** THE CHILDREN OF THE NATION. *Second Edition. Demy 8vo.* 7s. 6d. net.
- Goudge (H. L.), M.A.,** Principal of Wells Theological College. See Westminster Commentaries.
- Graham (P. Anderson).** THE RURAL EXODUS. *Cr. 8vo.* 2s. 6d.
- Granger (F. S.), M.A., Litt.D.** PSYCHOLOGY. *Third Edition. Cr. 8vo.* 2s. 6d.
- THE SOUL OF A CHRISTIAN.** *Cr. 8vo.* 6s.
- Gray (E. M'Queen).** GERMAN PASSAGES FOR UNSEEN TRANSLATION. *Cr. 8vo.* 2s. 6d.
- Gray (P. L.), B.Sc.** THE PRINCIPLES OF MAGNETISM AND ELECTRICITY: an Elementary Text-Book. With 18 Diagrams. *Cr. 8vo.* 3s. 6d.
- Green (G. Buckland), M.A.,** late Fellow of St. John's College, Oxon. NOTES ON GREEK AND LATIN SYNTAX. *Second Edition. Crown 8vo.* 3s. 6d.

- Green (E. T.), M.A.** See Churchman's Library.
- Greenidge (A. H. J.), M.A.** A HISTORY OF ROME: From 133-104 B.C. *Demy 8vo. 20s. 6d. net.*
- Greenwell (Dora).** See Miniature Library.
- Gregory (R. A.).** THE VAULT OF HEAVEN. A Popular Introduction to Astronomy. Illustrated. *Cr. 8vo. 2s. 6d.*
- Gregory (Miss E. C.).** See Library of Devotion.
- Grubb (H. C.).** See Textbooks of Technology.
- Gwynn (M. L.).** A BIRTHDAY BOOK. New and cheaper issue. *Royal 8vo. 5s. net.*
- Haddon (A. C.), Sc.D., F.R.S.** HEAD-HUNTERS BLACK, WHITE, AND BROWN. With many Illustrations and a Map. *Demy 8vo. 15s.*
- Hadfield (R. A.) and Gibbins (H. de B.).** A SHORTER WORKING DAY. *Cr. 8vo. 2s. 6d.*
- Hall (R. N.) and Neal (W. G.).** THE ANCIENT RUINS OF RHODESIA. Illustrated. *Second Edition, revised. Demy 8vo. 10s. 6d. net.*
- Hall (R. N.).** GREAT ZIMBABWE. With numerous Plans and Illustrations. *Second Edition. Royal 8vo. 10s. 6d. net.*
- Hamilton (F. J.), D.D.** See Byzantine Texts.
- Hammond (J. L.).** CHARLES JAMES FOX. *Demy 8vo. 10s. 6d.*
- Hannay (D.).** A SHORT HISTORY OF THE ROYAL NAVY, 1200-1688. Illustrated. *Demy 8vo. 7s. 6d. each.*
- Hannay (James O.), M.A.** THE SPIRIT AND ORIGIN OF CHRISTIAN MONASTICISM. *Cr. 8vo. 6s.*
- THE WISDOM OF THE DESERT.** *Fcap. 8vo. 3s. 6d. net.*
- Hardie (Martin).** See Connoisseur's Library.
- Hare (A. T.), M.A.** THE CONSTRUCTION OF LARGE INDUCTION COILS. With numerous Diagrams. *Demy 8vo. 6s.*
- Harrison (Clifford).** READING AND READERS. *Fcap. 8vo. 2s. 6d.*
- Harvey (Alfred), M.B.** See Ancient Cities.
- Hawthorne (Nathaniel).** See Little Library.
- HEALTH, WEALTH AND WISDOM.** *Cr. 8vo. 1s. net.*
- Heath (Frank R.).** See Little Guides.
- Heath (Dudley).** See Connoisseur's Library.
- Hello (Ernest).** STUDIES IN SAINTSHIP. Translated from the French by V. M. CRAWFORD. *Fcap. 8vo. 3s. 6d.*
- Henderson (B. W.),** Fellow of Exeter College, Oxford. THE LIFE AND PRINCIPATE OF THE EMPEROR NERO. Illustrated. *New and cheaper issue. Demy 8vo. 7s. 6d. net.*
- AT INTERVALS.** *Fcap. 8vo. 2s. 6d. net.*
- Henderson (T. F.).** See Little Library and Oxford Biographies.
- Henderson (T. F.), and Watt (Francis).** SCOTLAND OF TO-DAY. With many Illustrations, some of which are in colour. *Cr. 8vo. 6s.*
- Henley (W. E.).** ENGLISH LYRICS. *Second Edition. Cr. 8vo. 2s. 6d. net.*
- Henley (W. E.) and Whibley (C.)** A BOOK OF ENGLISH PROSE. *Cr. 8vo. 2s. 6d. net.*
- Henson (H. H.), B.D.,** Canon of Westminster. APOSTOLIC CHRISTIANITY: As Illustrated by the Epistles of St. Paul to the Corinthians. *Cr. 8vo. 6s.*
- LIGHT AND LEAVEN: HISTORICAL AND SOCIAL SERMONS.** *Cr. 8vo. 6s.*
- Herbert (George).** See Library of Devotion.
- Herbert of Cherbury (Lord).** See Miniature Library.
- Hewins (W. A. S.), B.A.** ENGLISH TRADE AND FINANCE IN THE SEVENTEENTH CENTURY. *Cr. 8vo. 2s. 6d.*
- Hewitt (Ethel M.)** A GOLDEN DIAL. A Day Book of Prose and Verse. *Fcap. 8vo. 2s. 6d. net.*
- Heywood (W.).** PALIO AND PONTE: A Book of Tuscan Games. Illustrated. *Royal 8vo. 21s. net.*
- See also St. Francis of Assisi.
- Hill (Clare).** See Textbooks of Technology.
- Hill (Henry), B.A.,** Headmaster of the Boy's High School, Worcester, Cape Colony. A SOUTH AFRICAN ARITHMETIC. *Cr. 8vo. 3s. 6d.*
- Hind (C. Lewis).** DAYS IN CORNWALL. With 16 Illustrations in Colour by WILLIAM PASCOE, and 20 Photographs. *Second Edition. Cr. 8vo. 6s.*
- A Colonial Edition is also published.
- Hirst (F. W.)** See Books on Business.
- Hoare (J. Douglas).** ARCTIC EXPLORATION. With 18 Illustrations and Maps. *Demy 8vo. 7s. 6d. net.*
- Hobhouse (L. T.),** Fellow of C.C.C., Oxford. THE THEORY OF KNOWLEDGE. *Demy 8vo. 10s. 6d. net.*
- Hobson (J. A.), M.A.** INTERNATIONAL TRADE: A Study of Economic Principles. *Cr. 8vo. 2s. 6d. net.*
- PROBLEMS OF POVERTY.** *Sixth Edition. Cr. 8vo. 2s. 6d.*
- THE PROBLEM OF THE UNEMPLOYED.** *Third Edition. Cr. 8vo. 2s. 6d.*
- Hodgkin (T.), D.C.L.** See Leaders of Religion.
- Hodgson (Mrs. W.)** HOW TO IDENTIFY OLD CHINESE PORCELAIN. *Second Edition. Post 8vo. 6s.*
- Hogg (Thomas Jefferson).** SHELLEY AT OXFORD. With an Introduction by R. A. STREATFIELD. *Fcap. 8vo. 2s. net.*
- Holden-Stone (G. de).** See Books on Business.
- Holdich (Sir T. H.), K.C.I.E.** THE INDIAN BORDERLAND: being a Personal Record of Twenty Years. Illustrated. *Demy 8vo. 10s. 6d. net.*
- A Colonial Edition is also published.

- Holdsworth (W. S.), M.A.** A HISTORY OF ENGLISH LAW. *In Two Volumes. Vol. 1. Demy 8vo. 10s. 6d. net.*
- Holland (H. Scott),** Canon of St. Paul's. See Library of Devotion.
- Holt (Emily),** THE SECRET OF POPULARITY: How to Achieve Social Success. *Cr. 8vo. 3s. 6d. net.*
A Colonial Edition is also published.
- Holyoake (G. J.),** THE CO-OPERATIVE MOVEMENT TO-DAY. *Fourth Edition. Cr. 8vo. 2s. 6d.*
- Hone (Nathaniel J.),** See Antiquary's Books.
- Hoppner.** See Little Galleries.
- Horace.** See Classical Translations.
- Horsburgh (E. L. S.), M.A.** WATERLOO: A Narrative and Criticism. With Plans. *Second Edition. Cr. 8vo. 5s.*
See also Oxford Biographies.
- Horth (A. C.),** See Textbooks of Technology.
- Horton (R. F.), D.D.** See Leaders of Religion.
- Hosie (Alexander),** MANCHURIA. With Illustrations and a Map. *Second Edition. Demy 8vo. 7s. 6d. net.*
A Colonial Edition is also published.
- How (F. D.),** SIX GREAT SCHOOLMASTERS. With Portraits and Illustrations. *Second Edition. Demy 8vo. 7s. 6d.*
- Howell (A. G. Ferrers),** FRANCISCAN DAYS. Translated and arranged by. *Cr. 8vo. 3s. 6d. net.*
- Howell (G.),** TRADE UNIONISM—NEW AND OLD. *Fourth Edition. Cr. 8vo. 2s. 6d.*
- Hudson (Robert),** MEMORIALS OF A WARWICKSHIRE PARISH. Illustrated. *Demy 8vo. 15s. net.*
- Huggins (Sir William), K.C.B., O.M., D.C.L., F.R.S.** THE ROYAL SOCIETY; OR, SCIENCE IN THE STATE AND IN THE SCHOOLS. With 25 Illustrations. *Wide Royal 8vo. 4s. 6d. net.*
- Hughes (C. E.),** THE PRAISE OF SHAKESPEARE. An English Anthology. With a Preface by SIDNEY LEE. *Demy 8vo. 3s. 6d. net.*
- Hughes (Thomas),** TOM BROWN'S SCHOOLDAYS. With an Introduction and Notes by VERNON RENDALL. *Leather. Royal 32mo. 2s. 6d. net.*
- Hutchinson (Horace G.)** THE NEW FOREST. Illustrated in colour with 50 Pictures by WALTER TYNDALE and 4 by LUCY KEMP-WELCH. *Third Edition. Cr. 8vo. 6s.*
- Hutton (A. W.), M.A.** See Leaders of Religion and Library of Devotion.
- Hutton (Edward),** THE CITIES OF UMBRIA. With many Illustrations, of which 20 are in Colour, by A. PISA. *Second Edition. Cr. 8vo. 6s.*
A Colonial Edition is also published.
- THE CITIES OF SPAIN. Second Edition.** With many Illustrations, of which 24 are in Colour, by A. W. RIMINGTON. *Demy 8vo. 7s. 6d. net.*
- FLORENCE AND NORTHERN TUSCANY.** With Coloured Illustrations by WILLIAM PARKINSON. *Cr. 8vo. 6s.*
A Colonial Edition is also published.
- ENGLISH LOVE POEMS.** Edited with an Introduction. *Fcap. 8vo. 3s. 6d. net.*
- Hutton (R. H.),** See Leaders of Religion.
- Hutton (W. H.), M.A.** THE LIFE OF SIR THOMAS MORE. With Portraits. *Second Edition. Cr. 8vo. 5s. 6d.*
See also Leaders of Religion.
- Hyde (A. G.)** GEORGE HERBERT AND HIS TIMES. With 32 Illustrations. *Demy 8vo. 10s. 6d. net.*
- Hyett (F. A.),** A SHORT HISTORY OF FLORENCE. *Demy 8vo. 7s. 6d. net.*
- Ibsen (Henrik),** BRANF. A Drama. Translated by WILLIAM WILSON. *Third Edition. Cr. 8vo. 3s. 6d.*
- Inge (W. R.), M.A.,** Fellow and Tutor of Hertford College, Oxford. CHRISTIAN MYSTICISM. The Bampton Lectures for 1899. *Demy 8vo. 12s. 6d. net.* See also Library of Devotion.
- Innes (A. D.), M.A.** A HISTORY OF THE BRITISH IN INDIA. With Maps and Plans. *Cr. 8vo. 6s.*
- ENGLAND UNDER THE TUDORS.** With Maps. *Demy 8vo. 10s. 6d. net.*
- Jackson (C. E.), B.A.** See Textbooks of Science.
- Jackson (S.), M.A.** See Commercial Series.
- Jackson (F. Hamilton),** See Little Guides.
- Jacob (F.), M.A.** See Junior Examination Series.
- James (W. H. N.), A.R.C.S., A.I.E.E.** See Textbooks of Technology.
- Jeans (J. Stephen),** TRUSTS, POOLS, AND CORNERS. *Cr. 8vo. 2s. 6d.*
See also Books on Business.
- Jeffreys (D. Gwyn),** DOLLY'S THEATRICALS. Described and Illustrated with 24 Coloured Pictures. *Super Royal 16mo. 2s. 6d.*
- Jenks (E.), M.A.,** Reader of Law in the University of Oxford. ENGLISH LOCAL GOVERNMENT. *Second Edition. Cr. 8vo. 2s. 6d.*
- Jenner (Mrs. H.),** See Little Books on Art.
- Jennings (Oscar), M.D.,** Member of the Bibliographical Society. EARLY WOODCUT INITIALS, containing over thirteen hundred Reproductions of Pictorial Letters of the Fifteenth and Sixteenth Centuries. *Demy 4to. 21s. net.*
- Jessopp (Augustus), D.D.** See Leaders of Religion.
- Jevons (F. B.), M.A., Litt.D.,** Principal of Bishop Hatfield's Hall, Durham. RELIGION IN EVOLUTION. *Cr. 8vo. 3s. 6d. net.*
See also Churchman's Library and Handbooks of Theology.
- Johnson (Mrs. Barham),** WILLIAM BOYHAM DONNE AND HIS FRIENDS. Illustrated. *Demy 8vo. 10s. 6d. net.*

Johnston (Sir H. H.), K.C.B. BRITISH CENTRAL AFRICA. With nearly 200 Illustrations and Six Maps. *Third Edition.* Cr. 4to. 18s. net.

A Colonial Edition is also published.

Jones (R. Crompton), M.A. POEMS OF THE INNER LIFE. Selected by. *Thirteenth Edition.* Fcap. 8vo. 2s. 6d. net.

Jones (H.). See Commercial Series.

Jones (H.G.). See Textbooks of Science.

Jones (L. A. Atherley), K.C., M.P. THE MINERS' GUIDE TO THE COAL MINES REGULATION ACTS. Cr. 8vo. 2s. 6d. net.

COMMERCE IN WAR. Royal 8vo. 21s. net.

Jonson (Ben). See Standard Library.

Julliana (Lady) of Norwich. REVELATIONS OF DIVINE LOVE. Ed. by GRACE WARRACK. *Second Edit.* Cr. 8vo. 3s. 6d.

Juvenal. See Classical Translations.

'Kappa.' LET YOUTH BUT KNOW: A Plea for Reason in Education. Cr. 8vo. 3s. 6d. net.

Kaufmann (M.). SOCIALISM AND MODERN THOUGHT. *Second Edition.* Cr. 8vo. 2s. 6d. net.

Keating (J. F.), D.D. THE AGAPE AND THE EUCHARIST. Cr. 8vo. 3s. 6d.

Keats (John). THE POEMS OF. Edited with Introduction and Notes by E. de Selincourt, M.A. *Second Edition.* Demy 8vo. 7s. 6d. net.

REALMS OF GOLD. Selections from the Works of. Fcap. 8vo. 3s. 6d. net.

See also Little Library and Standard Library.

Keble (John). THE CHRISTIAN YEAR. With an Introduction and Notes by W. Lock, D.D., Warden of Keble College. Illustrated by R. ANNING BELL. *Third Edition.* Fcap. 8vo. 3s. 6d.; padded morocco, 5s.

See also Library of Devotion.

Kelyack (T. N.), M.D., M.R.C.P., Hon. Secretary of the Society for the Study of Inebriety. THE DRINK PROBLEM IN ITS MEDICO-SOCIOLOGICAL ASPECT. Edited by. With 2 Diagrams. Demy 8vo. 7s. 6d. net.

Kempis (Thomas à). THE IMITATION OF CHRIST. With an Introduction by DEAN FARRAR. Illustrated by C. M. GERE. *Third Edition.* Fcap. 8vo. 3s. 6d.; padded morocco, 5s.

Also Translated by C. BIGG, D.D. Cr. 8vo. 3s. 6d. See also Library of Devotion and Standard Library.

Kennedy (Bart.). THE GREEN SPHINX. Cr. 8vo. 3s. 6d. net.

A Colonial Edition is also published.

Kennedy (James Houghton), D.D., Assistant Lecturer in Divinity in the University of Dublin. ST. PAUL'S SECOND AND THIRD EPISTLES TO THE CORINTHIANS. With Introduction, Dissertations and Notes. Cr. 8vo. 6s.

Keppins (C. W.), M.A. THE CHEMISTRY OF LIFE AND HEALTH. Illustrated. Cr. 8vo. 2s. 6d.

Kinglake (A. W.). See Little Library.

Kipling (Rudyard). BARRACK-ROOM BALLADS. *80th Thousand.* *Twenty-second Edition.* Cr. 8vo. 6s.

A Colonial Edition is also published.

THE SEVEN SEAS. *63rd Thousand.* *Eleventh Edition.* Cr. 8vo. 6s.

A Colonial Edition is also published.

THE FIVE NATIONS. *41st Thousand.* *Second Edition.* Cr. 8vo. 6s.

A Colonial Edition is also published.

DEPARTMENTAL DITTIES. *Sixteenth Edition.* Cr. 8vo. 6s.

A Colonial Edition is also published.

Knight (Albert E.). THE COMPLETE CRICKETER. Illus. Demy 8vo. 7s. 6d. net. A Colonial Edition is also published.

Knight (H. J. C.), M.A. See Churchman's Bible.

Knowling (R. J.), M.A., Professor of New Testament Exegesis at King's College, London. See Westminster Commentaries.

Lamb (Charles and Mary), THE WORKS OF. Edited by E. V. LUCAS. Illustrated in Seven Volumes. Demy 8vo. 7s. 6d. each. See also Little Library and E. V. Lucas.

Lambert (F. A. H.). See Little Guides.

Lambros (Professor). See Byzantine Texts.

Lane-Poole (Stanley). A HISTORY OF EGYPT IN THE MIDDLE AGES. Fully Illustrated. Cr. 8vo. 6s.

Langbridge (F.), M.A. BALLADS OF THE BRAVE: Poems of Chivalry, Enterprise, Courage, and Constancy. *Third Edition.* Cr. 8vo. 2s. 6d.

Law (William). See Library of Devotion and Standard Library.

Leach (Henry). THE DUKE OF DEVONSHIRE. A Biography. With 12 Illustrations. Demy 8vo. 12s. 6d. net.

See also James Braid.

GREAT GOLFERS IN THE MAKING.

With 34 Portraits. Demy 8vo. 7s. 6d. net.

Le Braz (Anatole). THE LAND OF PARDONS. Translated by FRANCES M. GOSTLING. Illustrated in colour. *Second Edition.* Demy 8vo. 7s. 6d. net.

Lee (Captain L. Melville). A HISTORY OF POLICE IN ENGLAND. Cr. 8vo. 3s. 6d. net.

Leigh (Percival). THE COMIC ENGLISH GRAMMAR. Embellished with upwards of 50 characteristic Illustrations by JOHN LEBCH. Post 16mo. 2s. 6d. net.

Lewes (V. B.), M.A. AIR AND WATER. Illustrated. Cr. 8vo. 2s. 6d.

Lewis (Mrs. Gwyn). A CONCISE HANDBOOK OF GARDEN SHRUBS. Illustrated. Fcap. 8vo. 3s. 6d. net.

Lisle (Fortuné de). See Little Bookson Art.

Littlehales (H.). See Antiquary's Books.

Lock (Walter), D.D., Warden of Keble College. ST. PAUL, THE MASTER-BUILDER. *Second Ed.* Cr. 8vo. 3s. 6d.

THE BIBLE AND CHRISTIAN LIFE. Cr. 8vo. 6s.

See also Leaders of Religion and Library of Devotion.

- Locker (F.)**. See Little Library.
- Lodge (Sir Oliver)**, F.R.S. THE SUBSTANCE OF FAITH ALLIED WITH SCIENCE: A Catechism for Parents and Teachers. *Eighth Ed.* Cr. 8vo. 2s. net.
- Lofthouse (W. F.)**, M.A. ETHICS AND ATONEMENT. With a Frontispiece. *Demy 8vo.* 5s. net.
- Longfellow (H. W.)**. See Little Library.
- Lorimer (George Horace)**. LETTERS FROM A SELF-MADE MERCHANT TO HIS SON. *Sixteenth Edition.* Cr. 8vo. 3s. 6d.
- A Colonial Edition is also published.
- OLD GORGON GRAHAM**. *Second Edition.* Cr. 8vo. 6s.
- A Colonial Edition is also published.
- Lover (Samuel)**. See I. P. L.
- E. V. L. and C. L. G.** ENGLAND DAY BY DAY: Or, The Englishman's Handbook to Efficiency. Illustrated by GEORGE MORROW. *Fourth Edition.* Fcap. 4to. 1s. net.
- Lucas (E. V.)**. THE LIFE OF CHARLES LAMB. With 25 Illustrations. *Third Edition.* *Demy 8vo.* 7s. 6d. net.
- A Colonial Edition is also published.
- A WANDERER IN HOLLAND**. With many Illustrations, of which 20 are in Colour by HERBERT MARSHALL. *Seventh Edition.* Cr. 8vo. 6s.
- A Colonial Edition is also published.
- A WANDERER IN LONDON**. With 16 Illustrations in Colour by NELSON DAWSON, and 36 other Illustrations. *Fifth Edition.* Cr. 8vo. 6s.
- A Colonial Edition is also published.
- FIRESIDE AND SUNSHINE**. *Third Edition.* Fcap. 8vo. 5s.
- THE OPEN ROAD**: a Little Book for Wayfarers. *Eleventh Edition.* Fcap. 8vo. 5s.; *India Paper.* 7s. 6d.
- THE FRIENDLY TOWN**: a Little Book for the Urbane. *Third Edition.* Fcap. 8vo. 5s.; *India Paper.* 7s. 6d.
- CHARACTER AND COMEDY**. *Second Edition*.
- Lucian**. See Classical Translations.
- Lyde (L. W.)**, M.A. See Commercial Series.
- Lydon (Noel S.)**. See Junior School Books.
- Lytelton (Hon. Mrs. A.)**. WOMEN AND THEIR WORK. Cr. 8vo. 2s. 6d.
- Macaulay (Lord)**. CRITICAL AND HISTORICAL ESSAYS. Edited by F. C. MONTAGUE, M.A. *Three Volumes.* Cr. 8vo. 18s.
- The only edition of this book completely annotated.
- M'Allen (J. E. B.)**, M.A. See Commercial Series.
- MacCulloch (J. A.)**. See Churchman's Library.
- MacCunn (Florence A.)**. MARY STUART. With over 60 Illustrations, including a Frontispiece in Photogravure. *Second and Cheaper Edition.* Cr. 8vo. 6s.
- See also Leaders of Religion.
- McDermott (E. R.)**. See Books on Business.
- M'Dowall (A. S.)**. See Oxford Biographies.
- Mackay (A. M.)**. See Churchman's Library.
- Macklin (Herbert W.)**, M.A. See Antiquary's Books.
- Mackenzie (W. Leslie)**, M.A., M.D., D.P.H., etc. THE HEALTH OF THE SCHOOL CHILD. Cr. 8vo. 2s. 6d.
- Mille Mori (Author of)**. ST. CATERINE OF SIENA AND HER TIMES. With 28 Illustrations. *Demy 8vo.* 7s. 6d. net.
- Magnus (Laurie)**, M.A. A PRIMER OF WORDSWORTH. Cr. 8vo. 6s. 6d.
- Mahaffy (J. P.)**, Litt.D. A HISTORY OF THE EGYPT OF THE PTOLEMIES. Fully Illustrated. Cr. 8vo. 6s.
- Maitland (F. W.)**, LL.D., Downing Professor of the Laws of England in the University of Cambridge. CANON LAW IN ENGLAND. *Royal 8vo.* 7s. 6d.
- Malden (H. E.)**, M.A. ENGLISH RECORDS. A Companion to the History of England. Cr. 8vo. 3s. 6d.
- THE ENGLISH CITIZEN: HIS RIGHTS AND DUTIES**. *Seventh Edition.* Cr. 8vo. 1s. 6d.
- See also School Histories.
- Marchant (E. C.)**, M.A., Fellow of Peterhouse, Cambridge. A GREEK ANTHOLOGY. *Second Edition.* Cr. 8vo. 3s. 6d.
- See also A. M. Cook.
- Marr (J. E.)**, F.R.S., Fellow of St John's College, Cambridge. THE SCIENTIFIC STUDY OF SCENERY. *Second Edition.* Illustrated. Cr. 8vo. 6s.
- AGRICULTURAL GEOLOGY**. Illustrated. Cr. 8vo. 6s.
- Marriott (J. A. R.)**. FALKLAND AND HIS TIMES. With 20 Illustrations. *Second Ed.* *Demy 8vo.* 7s. 6d. net.
- A Colonial Edition is also published.
- Marvell (Andrew)**. See Little Library.
- Masefield (John)**. SEA LIFE IN NELSON'S TIME. Illustrated. Cr. 8vo. 3s. 6d. net.
- ON THE SPANISH MAIN**. With 22 Illustrations and a Map. *Demy 8vo.* 10s. 6d. net.
- A SAILOR'S GARLAND**. Edited and Selected by. Cr. 8vo. 3s. 6d. net.
- Maskell (A.)**. See Connoisseur's Library.
- Mason (A. J.)**, D.D. See Leaders of Religion.
- Masse (George)**. THE EVOLUTION OF PLANT LIFE: Lower Forms. Illustrated. Cr. 8vo. 2s. 6d.
- Masterman (C. F. G.)**, M.A., M.P. TENNYSON AS A RELIGIOUS TEACHER. Cr. 8vo. 6s.
- Matheson (Mrs. E. F.)**. COUNSELS OF LIFE. Fcap. 8vo. 2s. 6d. net.
- May (Phil)**. THE PHIL MAY ALBUM. *Second Edition.* 4to. 1s. net.
- Mellows (Emma S.)**. A SHORT STORY OF ENGLISH LITERATURE. Cr. 8vo. 3s. 6d.
- Methuen (A. M. S.)**. THE TRAGEDY OF SOUTH AFRICA. Cr. 8vo. 2s. net.
- Also Cr. 8vo. 3d. net.
- A revised and enlarged edition of the author's 'Peace or War in South Africa.'

- ENGLAND'S RUIN: DISCUSSED IN SIXTEEN LETTERS TO THE RIGHT HON. JOSEPH CHAMBERLAIN, M.P. Seventh Edition.** Cr. 8vo. 3d. net.
- Miles (Eustace), M.A. LIFE AFTER LIFE, OR, THE THEORY OF REINCARNATION.** Cr. 8vo. 2s. 6d. net.
- Millaud (J. G.), THE LIFE AND LETTERS OF SIR JOHN EVERETT MILLAIS, President of the Royal Academy. With many Illustrations, of which 2 are in Photogravure. New Edition. Demy 8vo. 7s. 6d. net.**
See also Little Galleries.
- Millin (G. F.), PICTORIAL GARDENING.** Illustrated. Cr. 8vo. 3s. 6d. net.
- Mills (C. T.), M.I.M.E. See Textbooks of Technology.**
- Milne (J. G.), M.A. A HISTORY OF ROMAN EGYPPT.** Fully Illus. Cr. 8vo. 6s.
- Milton (John), A DAY BOOK OF.** Edited by R. F. Towndrow. Fcap. 8vo. 3s. 6d. net.
See also Little Library and Standard Library.
- Minchin (H. C.), M.A. See R. Peel.**
- Mitchell (P. Chalmers), M.A. OUTLINES OF BIOLOGY.** Illustrated. Second Edition. Cr. 8vo. 6s.
- Mitton (G. E.), JANE AUSTEN AND HER TIMES.** With many Portraits and Illustrations. Second and Cheaper Edition. Cr. 8vo. 6s.
A Colonial Edition is also published.
- Moffat (Mary M.), QUEEN LOUISA OF PRUSSIA.** With 20 Illustrations. Fourth Edition. Demy 8vo. 7s. 6d. net.
- Moll (A.), See Books on Business.**
- Molr (D. M.), See Little Library.**
- Mollinos (Dr. Michael de), See Library of Devotion.**
- Money (L. G. Chlozza), M.P. RICHES AND POVERTY.** Third Edition. Demy 8vo. 5s. net.
- Montagu (Henry), Earl of Manchester.** See Library of Devotion.
- Montaigne, A DAY BOOK OF.** Edited by C. F. Pond. Fcap. 8vo. 3s. 6d. net.
- Montmorency (J. E. G. de), B.A., LL.B. THOMAS A KEMPIS, HIS AGE AND BOOK.** With 22 Illustrations. Second Edition. Demy 8vo. 7s. 6d. net.
- Moore (H. E.), BACK TO THE LAND.** An Inquiry into Rural Depopulation. Cr. 8vo. 2s. 6d.
- Moorhouse (E. Hallam), NELSON'S LADY HAMILTON.** With 51 Portraits. Second Edition. Demy 8vo. 7s. 6d. net.
A Colonial Edition is also published.
- Moran (Clarence G.), See Books on Business.**
- Mors (Sir Thomas), See Standard Library.**
- Morfill (W. R.), Oriel College, Oxford. A HISTORY OF RUSSIA FROM PETER THE GREAT TO ALEXANDER II.** With Maps and Plans. Cr. 8vo. 3s. 6d.
- Morich (R. J.), late of Clifton College. See School Examination Series.**
- Morris (J.), THE MAKERS OF JAPAN.** With 24 Illustrations. Demy 8vo. 12s. 6d. net.
A Colonial Edition is also published.
- Morris (J. E.), See Little Guides.**
- Morton (Miss Anderson), See Miss Brodriek.**
- Moule (H. C. G.), D.D., Lord Bishop of Durham. See Leaders of Religion.**
- Muir (M. M. Pattison), M.A. THE CHEMISTRY OF FIRE.** Illustrated. Cr. 8vo. 2s. 6d.
- Mundella (V. A.), M.A. See J. T. Dunn.**
- Munro (R.), LL.D. See Antiquary's Books.**
- Naval Officer (A.), See I. P. L.**
- Neal (W. G.), See R. N. Hall.**
- Newman (Ernest), HUGO WOLF.** Demy 8vo. 6s.
- Newman (George), M.D., D.P.H., F.R.S.E., Lecturer on Public Health at St. Bartholomew's Hospital, and Medical Officer of Health of the Metropolitan Borough of Finsbury. INFANT MORTALITY, A SOCIAL PROBLEM.** With 16 Diagrams. Demy 8vo. 7s. 6d. net.
- Newman (J. H.) and others. See Library of Devotion.**
- Nichols (J. B. B.), See Little Library.**
- Nicklin (T.), M.A. EXAMINATION PAPERS IN THUCYDIDES.** Cr. 8vo. 2s.
- Nimrod. See I. P. L.**
- Norgate (G. Le Grys), THE LIFE OF SIR WALTER SCOTT.** Illustrated. Demy 8vo. 7s. 6d. net.
- Norregard (B. W.), THE GREAT SIEGE: The Investment and Fall of Port Arthur.** Illustrated. Demy 8vo. 10s. 6d. net.
- Norway (A. H.), NAPLES.** With 25 Coloured Illustrations by MAURICE GREIFFENHAGEN. Second Edition. Cr. 8vo. 6s.
- Novalls, THE DISCIPLES AT SAIS AND OTHER FRAGMENTS.** Edited by Miss UNA BIRCH. Fcap. 8vo. 3s. 6d.
- Oldfield (W. J.), M.A., Prebendary of Lincoln. A PRIMER OF RELIGION. BASED ON THE CATECHISM OF THE CHURCH OF ENGLAND.** Fcap. 8vo. 2s. 6d.
- Oldham (F. M.), B.A. See Textbooks of Science.**
- Oilphant (Mrs.), See Leaders of Religion.**
- Oman (C. W. C.), M.A., Fellow of All Souls', Oxford. A HISTORY OF THE ART OF WAR.** The Middle Ages, from the Fourth to the Fourteenth Century. Illustrated. Demy 8vo. 10s. 6d. net.
- Ottley (R. L.), D.D. See Handbooks of Theology and Leaders of Religion.**
- Overton (J. H.), See Leaders of Religion.**
- Owen (Douglas), See Books on Business.**
- Oxford (M. N.), of Guy's Hospital. A HANDBOOK OF NURSING.** Fourth Edition. Cr. 8vo. 3s. 6d.
- Pakes (W. C. C.), THE SCIENCE OF HYGIENE.** Illustrated. Demy 8vo. 15s.
- Palmer (Frederick), WITH KUROKI IN MANCHURIA.** Illustrated. Third Edition. Demy 8vo. 7s. 6d. net.

- Parker (Gilbert).** A LOVER'S DIARY. *Fcap. 8vo. 5s.*
- Parke (A. K.).** SMALL LESSONS ON GREAT TRUTHS. *Fcap. 8vo. 1s. 6d.*
- Parkinson (John).** PARADISI IN SOLE PARADISUS TERRESTRIS, OR A GARDEN OF ALL SORTS OF PLEASANT FLOWERS. *Folio. L3, 3s. net.*
- Parmenter (John).** HELIO-TROPES, OR NEW POSIES FOR SUNDIALS, 1625. Edited by PERCIVAL LONDON. *Quarto. 3s. 6d. net.*
- Parmentier (Prof. Leon).** See Byzantine Texts.
- Parsons (Mrs. Clement).** GARRICK AND HIS CIRCLE. With 36 Illustrations. *Second Edition. Demy 8vo. 12s. 6d. net.*
A Colonial Edition is also published.
- Pascal.** See Library of Devotion.
- Pastor (George).** SOCIAL CARICATURE IN THE EIGHTEENTH CENTURY. With over 200 Illustrations. *Imperial Quarto. L2, 12s. 6d. net.*
See also Little Books on Art and I. P. L.
- LADY MARY WORTLEY MONTAGU.** With 24 Portraits and Illustrations. *Second Edition. Demy 8vo. 15s. net.*
A Colonial Edition is also published.
- Pateron (W. R.)** (Benjamin Swift). LIFE'S QUESTIONINGS. *Cr. 8vo. 3s. 6d. net.*
- Patterson (A. H.).** NOTES OF AN EAST COAST NATURALIST. Illustrated in Colour by F. SOUTHGATE. *Second Edition. Cr. 8vo. 6s.*
- NATURE IN EASTERN NORFOLK.** A series of observations on the Birds, Fishes, Mammals, Reptiles, and Stalk-eyed Crustaceans found in that neighbourhood, with a list of the species. With 12 Illustrations in colour, by FRANK SOUTHGATE. *Second Edition. Cr. 8vo. 6s.*
- Peacock (N.).** See Little Books on Art.
- Peake (C. M. A.), F.R.H.S.** A CONCISE HANDBOOK OF GARDEN ANNUAL AND BIENNIAL PLANTS. With 24 Illustrations. *Fcap. 8vo. 3s. 6d. net.*
- Peel (Robert), and Minchin (H. C.), M.A.** OXFORD. With 100 Illustrations in Colour. *Cr. 8vo. 6s.*
- Peel (Sidney),** late Fellow of Trinity College, Oxford, and Secretary to the Royal Commission on the Licensing Laws. PRACTICAL LICENSING REFORM. *Second Edition. Cr. 8vo. 1s. 6d.*
- Petrie (W. M. Flinders), D.C.L., LL.D.,** Professor of Egyptology at University College. A HISTORY OF EGYPT, FROM THE EARLIEST TIMES TO THE PRESENT DAY. Fully Illustrated. *In six volumes. Cr. 8vo. 6s. each.*
- VOL. I. PREHISTORIC TIMES TO XVIIth DYNASTY. Sixth Edition.**
- VOL. II. THE XVIIth AND XVIIIth DYNASTIES. Fourth Edition.**
- VOL. III. XIXth TO XXXth DYNASTIES.**
- VOL. IV. THE EGYPT OF THE PTOLEMIES.** J. P. MAHAFFY, Litt. D.
- VOL. V. ROMAN EGYPT.** J. G. MITCHELL, M.A.
- VOL. VI. EGYPT IN THE MIDDLE AGES.** STANLEY LANR-POOLE, M.A.
- RELIGION AND CONSCIENCE IN ANCIENT EGYPT.** Illustrated. *Cr. 8vo. 2s. 6d.*
- SYRIA AND EGYPT, FROM THE TELL ELAMARNATABLETS.** *Cr. 8vo. 2s. 6d.*
- EGYPTIAN TALES.** Illustrated by TRISTRAM ELLIS. *In Two Volumes. Cr. 8vo. 3s. 6d. each.*
- EGYPTIAN DECORATIVE ART.** With 120 Illustrations. *Cr. 8vo. 3s. 6d.*
- Phillips (W. A.).** See Oxford Biographies.
- Phillipotts (Eden).** MY DEVON YEAR. With 38 Illustrations by J. LEY PETHYBRIDGE. *Second and Cheaper Edition. Large Cr. 8vo. 6s.*
- UP ALONG AND DOWN ALONG.** Illustrated by CLAUDE SHEPPERSON. *Cr. 4to. 5s. net.*
A volume of poems.
- Plarr (Victor G.).** See School Histories.
- Plato.** See Standard Library.
- Plautus.** THE CAPTIVE. Edited, with an Introduction, Textual Notes, and a Commentary, by W. M. LINDSAY, Fellow of Jesus College, Oxford. *Demy 8vo. 10s. 6d. net.*
- Plowden-Wardlaw (J. T.), B.A.,** King's College, Cambridge. See School Examination Series.
- Podmore (Frank).** MODERN SPIRITUALISM. *Two Volumes. Demy 8vo. 21s. net.*
A History and a Criticism.
- Poor (J. Patrick Le).** A MODERN LEGIONARY. *Cr. 8vo. 6s.*
- Pollard (Alice).** See Little Books on Art.
- Pollard (A. W.).** OLD PICTURE BOOKS. Illustrated. *Demy 8vo. 7s. 6d. net.*
- Pollard (Eliza F.).** See Little Books on Art.
- Pollock (David), M.I.N.A.** See Books on Business.
- Potter (M. C.), M.A., F.L.S.** A TEXT-BOOK OF AGRICULTURAL BOTANY. Illustrated. *Second Edition. Cr. 8vo. 4s. 6d.*
- Power (J. O'Connor).** THE MAKING OF AN ORATOR. *Cr. 8vo. 6s.*
- Prance (G.).** See R. Wyon.
- Prescott (O. L.).** ABOUT MUSIC, AND WHAT IT IS MADE OF. *Cr. 8vo. 3s. 6d. net.*
- Price (L. L.), M.A.,** Fellow of Oriel College, Oxon. A HISTORY OF ENGLISH POLITICAL ECONOMY. *Fourth Edition. Cr. 8vo. 2s. 6d.*
- Primrose (Deborah).** A MODERN BCEOTIA. *Cr. 8vo. 6s.*
- Protheroe (Ernest).** THE DOMINION OF MAN. GEOGRAPHY IN ITS HUMAN ASPECT. With 32 full-page Illustrations. *Cr. 8vo. 2s.*

- Pugin and Rowlandson.** THE MICRO-COSM OF LONDON, OR LONDON IN MINIATURE. With 104 Illustrations in colour. *In Three Volumes. Small 4to.* 63, 3s. net.
- Q.** (A. T. Quiller Couch). THE GOLDEN POMP. A PROCESSION OF ENGLISH LYRICS. *Second Edition. Cr. 8vo.* 2s. 6d. net.
- Quevedo Villegas.** See Miniature Library.
- G. R. and E. S.** THE WOODHOUSE CORRESPONDENCE. *Cr. 8vo.* 6s.
A Colonial Edition is also published.
- Rackham (R. B.), M.A.** See Westminster Commentaries.
- Ragg (Laura M.).** THE WOMEN-ARTISTS OF BOLOGNA. With 20 Illustrations. *Demy 8vo.* 7s. 6d. net.
- Ragg (Lonsdale), B.D.,** Oxon. DANTE AND HIS ITALY. With 32 Illustrations largely from contemporary Frescoes and Documents. *Demy 8vo.* 12s. 6d. net.
- Rahitz (F. J.), M.A., B.Sc.,** Lecturer in English at Merchant Venturers' Technical College, Bristol. HIGHER ENGLISH. *Second Edition. Cr. 8vo.* 3s. 6d.
- Randolph (B. W.), D.D.** See Library of Devotion.
- Rannie (D. W.), M.A.** A STUDENT'S HISTORY OF SCOTLAND. *Cr. 8vo.* 3s. 6d.
- Rashdall (Hastings), M.A.,** Fellow and Tutor of New College, Oxford. DOCTRINE AND DEVELOPMENT. *Cr. 8vo.* 6s.
- Raven (J. J.), D.D.** See Antiquary's Books.
- Rawstorne (Lawrence, Esq.).** See I.P.L.
- Raymond (Walter).** See School Histories.
- A Real Paddy.** See I.P.L.
- Reason (W.), M.A.** UNIVERSITY AND SOCIAL SETTLEMENTS. *Cr. 8vo.* 2s. 6d.
- Redpath (H. A.), M.A.** See Westminster Commentaries.
- Reynolds.** See Little Galleries.
- Rhodes (J. F.).** See Simplified French Texts.
- Rhodes (W. E.).** See School Histories.
- Rieu (H.), M.A.** See Simplified French Texts.
- Roberts (M. E.).** See C. C. Channer.
- Robertson (A.), D.D.,** Lord Bishop of Exeter. REGNUM DEI. The Bampton Lectures of 1901. *Demy 8vo.* 7s. 6d. net.
- Robertson (C. Grant), M.A.,** Fellow of All Souls' College, Oxford, Examiner in the Honours School of Modern History, Oxford, 1901-1904. SELECT STATUTES, CASES, AND CONSTITUTIONAL DOCUMENTS, 1660-1832. *Demy 8vo.* 10s. 6d. net.
- Robertson (C. Grant) and Bartholomew (J. G.), F.R.S.E., F.R.G.S.** A HISTORICAL AND MODERN ATLAS OF THE BRITISH EMPIRE. *Demy Quarto.* 4s. 6d. net.
- Robertson (Sir G. S.), K.C.S.I.** CHITRAL; THE STORY OF A MINOR SIEGE. *Third Edition. Illustrated. Cr. 8vo.* 2s. 6d. net.
- Robinson (A. W.), M.A.** See Churchman's Bible.
- Robinson (Cecilia).** THE MINISTRY OF DEACONESSES. With an Introduction by the late Archbishop of Canterbury. *Cr. 8vo.* 3s. 6d.
- Robinson (F. S.).** See Connoissen's Library.
- Rochevoucauld (La).** See Little Library.
- Rodwell (G.), B.A.** NEW TESTAMENT GREEK. A Course for Beginners. With a Preface by WALTER LOCK, D.D., Warden of Keble College. *Fcap. 8vo.* 3s. 6d.
- Roe (Fred).** OLD OAK FURNITURE. With many Illustrations by the Author, including a frontispiece in colour. *Demy 8vo.* 10s. 6d. net.
- Rogers (A. G. L.), M.A.** See Books on Business.
- Romney.** See Little Galleries.
- Roscoe (E. S.).** See Little Guides.
- Rose (Edward).** THE ROSE READER. Illustrated. *Cr. 8vo.* 2s. 6d. Also in 4 Parts. *Parts I. and II. 6d. each; Part III. 8d.; Part IV. 10d.*
- Rowntree (Joshua).** THE IMPERIAL DRUG TRADE. A RE-STATEMENT OF THE OPIUM QUESTION. *Second and Cheaper Edition. Cr. 8vo.* 2s. net.
- Royde-Smith (N. G.).** THE PILLOW BOOK: A GARNER OF MANY MOODS. *Second Edition. Cr. 8vo.* 4s. 6d. net.
- Ruble (A. E.), D.D.** See Junior School Books.
- Russell (W. Clark).** THE LIFE OF ADMIRAL LORD COLLINGWOOD. With Illustrations by F. BRANGWYN. *Fourth Edition. Cr. 8vo.* 6s.
- Sainsbury (Harrington), M.D., F.R.C.P.** PRINCIPIA THERAPEUTICA. *Demy 8vo.* 7s. 6d. net.
- St. Anselm.** See Library of Devotion.
- St. Augustine.** See Library of Devotion.
- St. Bernard.** See Library of Devotion.
- Sales (St. Francis de).** See Library of Devotion.
- St. Cyres (Viscount).** See Oxford Biographies.
- St. Francis of Assisi.** THE LITTLE FLOWERS OF THE GLORIOUS MESSER ST. FRANCIS AND HIS FRIARS. Newly translated by WILLIAM HAYWOOD. With an Introduction by A. G. F. HOWELL, and 40 Illustrations from Italian Painters. *Demy 8vo.* 5s. net.
See also Standard Library and Library of Devotion.
- 'Saki' (H. Munro).** REGINALD. *Second Edition. Fcap. 8vo.* 2s. 6d. net.
- Salmon (A. L.).** See Little Guides.
- Sargeant (J.), M.A.** ANNALS OF WESTMINSTER SCHOOL. Illustrated. *Demy 8vo.* 7s. 6d.
- Sathas (C.).** See Byzantine Texts.
- Schmitt (John).** See Byzantine Texts.
- Scott (A. M.).** WINSTON SPENCER CHURCHILL. With Portraits and Illustrations. *Cr. 8vo.* 3s. 6d.
- Scudamore (Cyril).** See Little Guides.

- Sells (V. P.), M.A.** THE MECHANICS OF DAILY LIFE. Illustrated. *Cr. 8vo.* 2s. 6d.
- Selous (Edmund).** TOMMY SMITH'S ANIMALS. Illustrated by G. W. ORD. *Ninth Edition. Fcap. 8vo.* 2s. 6d. *School Edition, 1s. 6d.*
- TOMMY SMITH'S OTHER ANIMALS.** With 12 Illustrations by AUGUSTA GUEST. *Third Edition. Fcap. 8vo.* 2s. 6d.
- Settle (J. H.).** ANECDOTES OF SOLDIERS. *Cr. 8vo.* 3s. 6d. net.
- Shakespeare (William).** THE FOUR FOLIOS, 1623; 1632; 1664; 1685. Each £4, 4s. net, or a complete set, £12, 2s. net.
Folios 3 and 4 are ready.
Folio 2 is nearly ready.
See also Arden, Standard Library and Little Quarto Shakespeare.
- Sharp (A.).** VICTORIAN POETS. *Cr. 8vo.* 2s. 6d.
See S. Baring-Gould.
- Sharp (Cecil).** See S. Baring-Gould.
- Sharp (Mrs. E. A.).** See Little Books on Art.
- Shedlock (J. S.).** THE PIANOFORTE SONATA. *Cr. 8vo.* 5s.
- Shelley (Percy B.).** ADONAI; an Elegy on the death of John Keats, Author of 'Endymion,' etc. Pisa. From the types of Didot, 1821. 2s. net.
- Sheppard (H. F.), M.A.** See S. Baring-Gould.
- Sherwell (Arthur), M.A.** LIFE IN WEST LONDON. *Third Edition. Cr. 8vo.* 2s. 6d.
- Shipley (Mary E.).** AN ENGLISH CHURCH HISTORY FOR CHILDREN. A.D. 597-1066. With a Preface by the Bishop of Gibraltar. With Maps and Illustrations. *Cr. 8vo.* 2s. 6d. net.
- Sime (J.).** See Little Books on Art.
- Simonson (G. A.).** FRANCESCO GUARDI. With 41 Plates. *Imperial 4to.* £2, 2s. net.
- Sketchley (R. E. D.).** See Little Books on Art.
- Skipton (H. P. K.).** See Little Books on Art.
- Sladen (Douglas).** SICILY: The New Winter Resort. With over 200 Illustrations. *Second Edition. Cr. 8vo.* 5s. net.
- Small (Evan), M.A.** THE EARTH. An Introduction to Physiography. Illustrated. *Cr. 8vo.* 2s. 6d.
- Smallwood (M. G.).** See Little Books on Art.
- Smedley (F. E.).** See I.P.L.
- Smith (Adam).** THE WEALTH OF NATIONS. Edited with an Introduction and numerous Notes by EDWIN CANNAN, M.A. *Two volumes. Demy 8vo.* 22s. net.
- Smith (Horace and James).** See Little Library.
- Smith (H. Bompas), M.A.** A NEW JUNIOR ARITHMETIC. *Crown 8vo.* 2s. With Answers, 2s. 6d.
- Smith (R. Mudie).** THOUGHTS FOR THE DAY. Edited by. *Fcap. 8vo.* 3s. 6d. net.
- Smith (Nowell C.).** See W. Wordsworth.
- Smith (John Thomas).** A BOOK FOR A RAINY DAY: Or, Recollections of the Events of the Years 1766-1833. Edited by WILFRED WHITTEN. Illustrated. *Wide Demy 8vo.* 12s. 6d. net.
- Snell (F. J.).** A BOOK OF EXMOOR. Illustrated. *Cr. 8vo.* 6s.
- Snowden (C. E.).** A HANDY DIGEST OF BRITISH HISTORY. *Demy 8vo.* 4s. 6d.
- Sophocles.** See Classical Translations.
- Sornet (L. A.).** See Junior School Books.
- South (E. Wilton), M.A.** See Junior School Books.
- Southey (R.).** ENGLISH SEAMEN. Edited by DAVID HANNAV.
Vol. 1. (Howard, Clifford, Hawkins, Drake, Cavendish). *Second Edition. Cr. 8vo.* 6s.
Vol. II. (Richard Hawkins, Grenville, Essex, and Raleigh). *Cr. 8vo.* 6s.
See also Standard Library.
- Spence (C. H.), M.A.** See School Examination Series.
- Spicer (A. D.).** THE PAPER TRADE. With Maps and Diagrams. *Demy 8vo.* 12s. 6d. net.
- Spooner (W. A.), M.A.** See Leaders of Religion.
- Staley (Edgcumbe).** THE GUILDS OF FLORENCE. Illustrated. *Second Edition. Royal 8vo.* 16s. net.
- Stanbridge (J. W.), B.D.** See Library of Devotion.
- 'Stancilffe.'** GOLF DO'S AND DONT'S. *Second Edition. Fcap. 8vo.* 1s.
- Stead (W. J.).** See D. Gallaher.
- Stedman (A. M. M.), M.A.**
- INITIAL LATINA: Easy Lessons on Elementary Accidence. Tenth Edition. Fcap. 8vo.** 1s.
- FIRST LATIN LESSONS. Tenth Edition. Cr. 8vo.** 2s.
- FIRST LATIN READER.** With Notes adapted to the Shorter Latin Primer and Vocabulary. *Seventh Ed. revised. 18mo.* 1s. 6d.
- EASY SELECTIONS FROM CÆSAR.** The Helvetian War. *Third Edition. 18mo.* 1s.
- EASY SELECTIONS FROM LIVY.** The Kings of Rome. *18mo. Third Edition. 1s. 6d.*
- EASY LATIN PASSAGES FOR UNSEEN TRANSLATION. Eleventh Ed. Fcap. 8vo.** 1s. 6d.
- EXEMPLA LATINA.** First Exercises in Latin Accidence. With Vocabulary. *Third Edition. Cr. 8vo.* 1s.

- EASY LATIN EXERCISES ON THE SYNTAX OF THE SHORTER AND REVISED LATIN PRIMER.** With Vocabulary. *Eleventh and Cheaper Edition, re-written.* Cr. 8vo. 1s. 6d. *Original Edition.* 2s. 6d. Key, 3s. net.
- THE LATIN COMPOUND SENTENCE :** Rules and Exercises. *Second Edition.* Cr. 8vo. 1s. 6d. With Vocabulary. 2s.
- NOTANDA QUÆDAM :** Miscellaneous Latin Exercises on Common Rules and Idioms. *Fourth Edition.* Fcap. 8vo. 1s. 6d. With Vocabulary. 2s. Key, 2s. net.
- LATIN VOCABULARIES FOR REPE- TITION :** Arranged according to Subjects. *Fourteenth Edition.* Fcap. 8vo. 1s. 6d.
- A VOCABULARY OF LATIN IDIOMS.** 18mo. *Fourth Edition.* 1s.
- STEPS TO GREEK.** *Third Edition, re-vised.* 18mo. 1s.
- A SHORTER GREEK PRIMER.** *Second Edition.* Cr. 8vo. 1s. 6d.
- EASY GREEK PASSAGES FOR UNSEEN TRANSLATION.** *Fourth Edition, re-vised.* Fcap. 8vo. 1s. 6d.
- GREEK VOCABULARIES FOR RE- PETITION.** Arranged according to Sub-jects. *Fourth Edition.* Fcap. 8vo. 1s. 6d.
- GREEK TESTAMENT SELECTIONS.** For the use of Schools. With Introduc- tion, Notes, and Vocabulary. *Fourth Edition.* Fcap. 8vo. 2s. 6d.
- STEPS TO FRENCH.** *Eighth Edition.* 18mo. 8d.
- FIRST FRENCH LESSONS.** *Seventh Edi- tion, re-vised.* Cr. 8vo. 1s.
- EASY FRENCH PASSAGES FOR UN- SEEN TRANSLATION.** *Fifth Edi- tion, re-vised.* Fcap. 8vo. 1s. 6d.
- EASY FRENCH EXERCISES ON ELE- MENTARY SYNTAX.** With Vocabulary. *Fourth Edition.* Cr. 8vo. 2s. 6d. Key, 3s. net.
- FRENCH VOCABULARIES FOR RE- PETITION :** Arranged according to Sub-jects. *Thirteenth Edition.* Fcap. 8vo. 1s. See also School Examination Series.
- Steel (R. Elliott), M.A., F.C.S. THE WORLD OF SCIENCE.** With 147 Illustrations. *Second Edition.* Cr. 8vo. 2s. 6d. See also School Examination Series.
- Stephenson (C.),** of the Technical College, Bradford, and **Suddards (F.)** of the Yorkshire College, Leeds. **ORNAMEN- TAL DESIGN FOR WOVEN FABRICS.** Illustrated. *Demy 8vo.* *Third Edition.* 7s. 6d.
- Stephenson (J.), M.A. THE CHIEF TRUTHS OF THE CHRISTIAN FAITH.** Cr. 8vo. 3s. 6d.
- Sterne (Laurence).** See Little Library.
- Sterry (W.), M.A. ANNALS OF ETON COLLEGE.** Illustrated. *Demy 8vo.* 7s. 6d.
- Stewart (Katherine).** BY ALLAN WATER. *Second Edition.* Cr. 8vo. 6s.
- Stevenson (R. L.) THE LETTERS OF ROBERT LOUIS STEVENSON TO HIS FAMILY AND FRIENDS.** Selected and Edited by SIDNEY COLVIN. *Third Edition.* Cr. 8vo. 12s.
- LIBRARY EDITION.** *Demy 8vo.* 2 vols. 25s. net. A Colonial Edition is also published.
- VAILIMA LETTERS.** With an Etched Portrait by WILLIAM STRANG. *Fifth Edition.* Cr. 8vo. Buckram. 6s.
- A Colonial Edition is also published.
- THE LIFE OF R. L. STEVENSON.** See G. Balfour.
- Stevenson (M. I.) FROM SARANAC TO THE MARQUESSAS.** Being Letters written by Mrs. M. I. STEVENSON during 1887-8. Cr. 8vo. 6s. net.
- LETTERS FROM SAMOA, 1891-95.** Edited and arranged by M. C. BALFOUR. With many Illustrations. *Second Edition.* Cr. 8vo. 6s. net.
- Stoddart (Anna M.).** See Oxford Bio- graphies.
- Stokes (F. G.), B.A. HOURS WITH RABELAIS.** From the translation of SIR T. URQUHART and P. A. MOTTEUX. With a Portrait in Photogravure. Cr. 8vo. 3s. 6d. net.
- Stone (S. J.). POEMS AND HYMNS.** With a Memoir by F. G. ELLERTON, M.A. With Portrait. Cr. 8vo. 6s.
- Storr (Vernon F.), M.A.,** Lecturer in the Philosophy of Religion in Cambridge University; Examining Chaplain to the Archbishop of Canterbury; formerly Fellow of University College, Oxford. **DEVELOP- MENT AND DIVINE PURPOSE.** Cr. 8vo. 5s. net.
- Straker (F.).** See Books on Business.
- Streano (A. W.), D.D.** See Churchman's Bible.
- Streatfield (R. A.). MODERN MUSIC AND MUSICIANS.** With 24 Illustrations. *Second Edition.* *Demy 8vo.* 7s. 6d. net.
- Stroud (H.), D.Sc., M.A. PRACTICAL PHYSICS.** With many Diagrams. *Second Edition.* 3s. net.
- Strutt (Joseph). THE SPORTS AND PASTIMES OF THE PEOPLE OF ENGLAND.** Illustrated by many Engrav- ings. Revised by J. CHARLES COX, LL.D., F.S.A. *Quarto.* 21s. net.
- Stuart (Capt. Donald). THE STRUGGLE FOR PERKIA.** With a Map. Cr. 8vo. 6s.
- Sturch (F.),** Staff Instructor to the Surrey County Council. **MANUAL TRAINING DRAWING (WOODWORK).** Its Prin- ciples and Application, with Solutions to Examination Questions, 1892-1905, Ortho- graphic, Isometric and Oblique Projection. With 50 Plates and 140 Figures. *Foolscap.* 5s. net.
- Suddards (F.).** See C. Stephenson.
- Surtees (R. S.).** See I.P.L.
- Symes (J. E.), M.A. THE FRENCH REVOLUTION.** *Second Edition.* Cr. 8vo. 2s. 6d.

- Sympson (E. M.), M.A., M.D.** See Ancient Cities.
- Tacitus. AGRICOLA.** With Introduction Notes, Map, etc., by R. F. DAVIS, M.A., *Fcap. 8vo. 2s.*
- GERMANIA.** By the same Editor. *Fcap. 8vo. 2s.* See also Classical Translations.
- Tallack (W.). HOWARD LETTERS AND MEMORIES.** *Demy 8vo. 10s. 6d. net.*
- Tauler (J.).** See Library of Devotion.
- Taylor (A. E.). THE ELEMENTS OF METAPHYSICS.** *Demy 8vo. 10s. 6d. net.*
- Taylor (F. G.), M.A.** See Commercial Series.
- Taylor (I. A.).** See Oxford Biographies.
- Taylor (John W.). THE COMING OF THE SAINTS: Imagination and Studies in Early Church History and Tradition.** With 26 Illustrations. *Demy 8vo. 7s. 6d. net.*
- Taylor (T. M.), M.A.,** Fellow of Gonville and Caius College, Cambridge. A CONSTITUTIONAL AND POLITICAL HISTORY OF ROME. *Cr. 8vo. 7s. 6d.*
- Tennyson (Alfred, Lord). THE EARLY POEMS OF.** Edited, with Notes and an Introduction, by J. CHURTON COLLINS, M.A. *Cr. 8vo. 6s.*
- IN MEMORIAM, MAUD, AND THE PRINCESS.** Edited by J. CHURTON COLLINS, M.A. *Cr. 8vo. 6s.* See also Little Library.
- Terry (C. S.).** See Oxford Biographies.
- Thackeray (W. M.).** See Little Library.
- Theobald (F. V.), M.A. INSECT LIFE.** Illustrated. *Second Edition Revised. Cr. 8vo. 2s. 6d.*
- Thompson (A. H.).** See Little Guides.
- Tilston (Mary W.). DAILY STRENGTH FOR DAILY NEEDS.** *Thirteenth Edition. Medium 16mo. 2s. 6d. net.* Also an edition in superior binding, 6s.
- Tompkins (H. W.), F.R.H.S.** See Little Guides.
- Townley (Lady Susan). MY CHINESE NOTE-BOOK.** With 16 Illustrations and 2 Maps. *Third Edition. Demy 8vo. 10s. 6d. net.*
- Toynbee (Paget), M.A., D.Litt.** See Oxford Biographies.
- Trench (Herbert). DEIRDRE WEDDED AND OTHER POEMS.** *Cr. 8vo. 5s.*
An episode of Thirty hours delivered by the three voices. It deals with the love of Deirdre for Nairis and is founded on a Gaelic Version of the Tragical Tale of the Sons of Uisnach.
- Trevelyan (G. M.),** Fellow of Trinity College, Cambridge. ENGLAND UNDER THE STUARTS. With Maps and Plans. *Second Edition. Demy 8vo. 10s. 6d. net.*
- Troutbeck (G. E.).** See Little Guides.
- Tyler (E. A.), B.A., F.C.S.** See Junior School Books.
- Tyrrall-Gill (Frances).** See Little Books on Art.
- Vardon (Harry). THE COMPLETE GOLFER.** Illustrated. *Eighth Edition. Demy 8vo. 10s. 6d. net.*
A Colonial Edition is also published.
- Vaughan (Henry).** See Little Library.
- Vaughan (Herbert M.), B.A. (Oxon.). THE LAST OF THE ROYAL STUARTS, HENRY STUART, CARDINAL, DUKE OF YORK.** With 20 Illustrations. *Second Edition. Demy 8vo. 10s. 6d. net.*
- THE NAPLES RIVERIA.** With 25 Illustrations in Colour by MAURICE GREIFFENHAGEN. *Cr. 8vo. 6s.*
A Colonial Edition is also published.
- Voegelin (A.), M.A.** See Junior Examination Series.
- Waddell (Col. L. A.), LL.D., C.B. LHASA AND ITS MYSTERIES.** With a Record of the Expedition of 1903-1904. With 155 Illustrations and Maps. *Third and Cheaper Edition. Demy 8vo. 7s. 6d. net.*
- Wade (G. W.), D.D. OLD TESTAMENT HISTORY.** With Maps. *Fourth Edition. Cr. 8vo. 6s.*
- Wagner (Richard). MUSIC DRAMAS: Interpretations, embodying Wagner's own explanations.** By A. L. CLEATHER and B. CRUMP. *In Four Volumes. Fcap 8vo. 2s. 6d. each.*
VOL. I.—THE RING OF THE NIBELUNG. *Third Edition.*
VOL. II.—PARSIFAL, LOHENGRIN, and THE HOLY GRAIL.
VOL. III.—TRISTAN AND ISOLDE.
- Wall (J. C.). DEVILS.** Illustrated by the Author and from photographs. *Demy 8vo. 4s. 6d. net.* See also Antiquary's Books.
- Walters (H. B.).** See Little Books on Art and Classics of Art.
- Walton (F. W.).** See School Histories.
- Walton (Isaac) and Cotton (Charles).** See I.P.L., Standard Library, and Little Library.
- Warren-Vernon (Hon. William), M.A. READINGS ON THE INFERNO OF DANTE,** based on the Commentary of BENVENUTO DA INOLA and other authorities. With an Introduction by the Rev. Dr. MOORE. *In Two Volumes. Second Edition, entirely re-written. Cr. 8vo. 12s. net.*
- Waterhouse (Mrs. Alfred). WITH THE SIMPLE HEARTED: Little Homilies to Women in Country Places.** *Second Edition. Small Pott 8vo. 2s. net.*
See also Little Library.
- Weatherhead (T. C.), M.A. EXAMINATION PAPERS IN HORACE.** *Cr. 8vo. 2s.* See also Junior Examination Series.
- Webber (F. C.).** See Textbooks of Technology.
- Weir (Archibald), M.A. AN INTRODUCTION TO THE HISTORY OF MODERN EUROPE.** *Cr. 8vo. 6s.*
- Wells (Sidney H.)** See Textbooks of Science.
- Wells (J.), M.A.,** Fellow and Tutor of Wadham College, OXFORD AND OXFORD LIFE. *Third Edition. Cr. 8vo. 3s. 6d.*
- A SHORT HISTORY OF ROME.** *Seventh Edition.* With 3 Maps. *Cr. 8vo. 3s. 6d.*
See also Little Guide.
- Wheldon (F. W.). A LITTLE BROTHER TO THE BIRDS.** With 15 Illustrations,

- of which are by A. H. BUCKLAND. *Large Cr. 8vo. 6s.*
- Whibley (C.)**. See W. E. Henley.
- Whibley (L.)**, M.A., Fellow of Pembroke College, Cambridge. GREEK OLIGARCHIES: THEIR ORGANISATION AND CHARACTER. *Cr. 8vo. 6s.*
- Whitaker (G. H.)**, M.A. See Churchman's Bible.
- White (Gilbert)**. THE NATURAL HISTORY OF SELBORNE. Edited by L. C. MIALL, F.R.S., assisted by W. WARDE FOWLER, M.A. *Cr. 8vo. 6s.*
See also Standard Library.
- Whitfield (E. E.)**. See Commercial Series.
- Whitehead (A. W.)**. GASPARD DE COLIGNY. Illustrated. *Demy 8vo. 12s. 6d. net.*
- Whiteley (R. Lloyd)**, F.I.C., Principal of the Municipal Science School, West Bromwich. AN ELEMENTARY TEXT-BOOK OF INORGANIC CHEMISTRY. *Cr. 8vo. 2s. 6d.*
- Whitley (Miss)**. See Lady Dilke.
- Whitten (W.)**. See John Thomas Smith.
- Whyte (A. G.)**, B.Sc. See Books on Business.
- Wilberforce (Wilfrid)**. See Little Books on Art.
- Wilde (Oscar)**. DE PROFUNDIS. *Ninth Edition. Cr. 8vo. 5s. net.*
A Colonial Edition is also published.
- THE DUCHESS OF PADUA**. *Demy 8vo. 12s. 6d. net.*
- POKMS**. *Demy 8vo. 12s. 6d. net.*
- INTENTIONS**. *Demy 8vo. 12s. 6d. net.*
- SALOME, AND OTHER PLAYS**. *Demy 8vo. 12s. 6d. net.*
- LADY WINDERMERE'S FAN**. *Demy 8vo. 12s. 6d. net.*
- A WOMAN OF NO IMPORTANCE**. *Demy 8vo. 12s. 6d. net.*
- AN IDEAL HUSBAND**. *Demy 8vo. 12s. 6d. net.*
- THE IMPORTANCE OF BEING EARNEST**. *Demy 8vo. 12s. 6d. net.*
- A HOUSE OF POMEGRANATES and THE HAPPY PRINCE**. *Demy 8vo. 12s. 6d. net.*
- LORD ARTHUR SAVILE'S CRIME and OTHER PROSE PIECES**. *Demy 8vo. 12s. 6d. net.*
- Wilkins (W. H.)**, B.A. THE ALIEN INVASION. *Cr. 8vo. 2s. 6d.*
- Williams (A.)**. PETROL PETER: or Pretty Stories and Funny Pictures. Illustrated in Colour by A. W. MILLS. *Demy 4to. 3s. 6d. net.*
- Williamson (M. G.)**. See Ancient Cities.
- Williamson (W.)**. THE BRITISH GARDENER. Illustrated. *Demy 8vo. 10s. 6d.*
- Williamson (W.)**, B.A. See Junior Examination Series, Junior School Books, and Beginner's Books.
- Wilson (Beckles)**. LORD STRATHCONA: the Story of his Life. Illustrated. *Demy 8vo. 7s. 6d.*
A Colonial Edition is also published.
- Wilmot-Buxton (E. M.)**. MAKERS OF EUROPE. *Cr. 8vo. Seventh Ed. 3s. 6d.*
A Text-book of European History for Middle Forms.
- THE ANCIENT WORLD**. With Maps and Illustrations. *Cr. 8vo. 3s. 6d.*
See also Beginner's Books.
- Wilson (Bishop.)**. See Library of Devotion.
- Wilson (A. J.)**. See Books on Business.
- Wilson (H. A.)**. See Books on Business.
- Wilson (J. A.)**. See Simplified French Texts.
- Wilton (Richard)**, M.A. LYRA PASTORALIS: Songs of Nature, Church, and Home. *Pott 8vo. 2s. 6d.*
- Winbolt (S. E.)**, M.A. EXERCISES IN LATIN ACCIDENCE. *Cr. 8vo. 1s. 6d.*
- LATIN HEXAMETER VERSE: An Aid to Composition**. *Cr. 8vo. 3s. 6d. KEY, 5s. net.*
- Windle (B. C. A.)**, F.R.S., F.S.A. See Antiquary's Books, Little Guides, Ancient Cities, and School Histories.
- Winterbotham (Canon)**, M.A., B.Sc., LL.B. See Churchman's Library.
- Wood (Sir Evelyn)**, F.M., V.C., G.C.B., G.C.M.G. FROM MIDSHIPMAN TO FIELD-MARSHAL. With 24 Illustrations and Maps. *Two Volumes. Fourth Edition. Demy 8vo. 25s. net.*
A Colonial Edition is also published.
- Wood (J. A. E.)**. See Textbooks of Technology.
- Wood (J. Hickory)**. DAN LENO. Illustrated. *Third Edition. Cr. 8vo. 6s.*
A Colonial Edition is also published.
- Wood (W. Birkbeck)**, M.A., late Scholar of Worcester College, Oxford, and **Edmonds (Major J. E.)**, R.E., D.A.Q.-M.G. A HISTORY OF THE CIVIL WAR IN THE UNITED STATES. With an Introduction by H. SPENSER WILKINSON. With 24 Maps and Plans. *Demy 8vo. 12s. 6d. net.*
- Wordsworth (Christopher)**. See Antiquary's Books.
- Wordsworth (W.)**. POEMS BY. Selected by STOPFORD A. BROOKE. With 40 Illustrations by EDMUND H. NSW. With a Frontispiece in Photogravure. *Demy 8vo. 7s. 6d. net.*
A Colonial Edition is also published.
- Wordsworth (W.) and Coleridge (S. T.)**. See Little Library.
- Wright (Arthur)**, D.D., Fellow of Queen's College, Cambridge. See Churchman's Library.
- Wright (C. Gordon)**. See Dante.
- Wright (J. C.)**. TO-DAY. *Demy 16mo. 1s. 6d. net.*
- Wright (Sophie)**. GERMAN VOCABULARIES FOR REPETITION. *Fcap. 8vo. 1s. 6d.*
- Wrong (George M.)**, Professor of History in the University of Toronto. THE EARL OF ELGIN. Illustrated. *Demy 8vo. 7s. 6d. net.*
A Colonial Edition is also published.

Wyatt (Kate M.). See M. R. Gloag.
Wyde (A. B.). MODERN ABYSSINIA.
 With a Map and a Portrait. *Demy 8vo.*
15s. net.

A Colonial Edition is also published.

Wyndham (Rt. Hon. George), M.P. THE
 POEMS OF WILLIAM SHAKESPEARE.
 With an Introduction and
 Notes. *Demy 8vo. Buckram, gilt top.*
10s. 6d.

Wyon (R.) and Prance (G.). THE LAND
 OF THE BLACK MOUNTAIN. Being a
 Description of Montenegro. With 40
 Illustrations. *Cr. 8vo. 2s. 6d. net.*

Yeats (W. B.). A BOOK OF IRISH
 VERSE. Selected from Modern Writers.

Revised and Enlarged Edition. Cr. 8vo.
3s. 6d.

Young (Filson). THE COMPLETE
 MOTORIST. With 138 Illustrations.
Sixth Edition. Demy 8vo. 12s. 6d. net.

A Colonial Edition is also published.

THE JOY OF THE ROAD: An Appreciation
 of the Motor Car. *Small Demy 8vo.*
5s. net.

Young (T. M.). THE AMERICAN
 COTTON INDUSTRY: A Study of
 Work and Workers. *Cr. 8vo. Cloth, 2s. 6d. ;*
paper boards, 1s. 6d.

Zimmern (Antonia). WHAT DO WE
 KNOW CONCERNING ELECTRI-
 CITY? *Fcap. 8vo. 1s. 6d. net.*

Ancient Cities

General Editor, B. C. A. WINDLE, D.Sc., F.R.S.*

Cr. 8vo. 4s. 6d. net.

CHESTER. By B. C. A. Windle, D.Sc. F.R.S.
 Illustrated by E. H. New.

SHREWSBURY. By T. Auden, M.A., F.S.A.
 Illustrated.

CANTERBURY. By J. C. Cox, LL.D., F.S.A.
 Illustrated.

EDINBURGH. By M. G. Williamson, M.A.
 Illustrated by Herbert Railton.

LINCOLN. By E. Mansel Sympson, M.A.,
 M.D. Illustrated by E. H. New.

BRISTOL. By Alfred Harvey. Illustrated
 by E. H. New.

DUBLIN. By S. A. O. Fitzpatrick. Illustrated
 by W. C. Green.

The Antiquary's Books

General Editor, J. CHARLES COX, LL.D., F.S.A.

Demy 8vo. 7s. 6d. net.

ENGLISH MONASTIC LIFE. By the Right
 Rev. Abbot Gasquet, O.S.B. Illustrated.
Third Edition.

**REMAINS OF THE PREHISTORIC AGE IN
 ENGLAND.** By B. C. A. Windle, D.Sc.,
 F.R.S. With numerous Illustrations and
 Plans.

**OLD SERVICE BOOKS OF THE ENGLISH
 CHURCH.** By Christopher Wordsworth,
 M.A., and Henry Littlehales. With
 Coloured and other Illustrations.

CELTIC ART. By J. Romilly Allen, F.S.A.
 With numerous Illustrations and Plans.

ARCHAEOLOGY AND FALSE ANTIQUITIES.
 By R. Munro, LL.D. Illustrated.

SHRINES OF BRITISH SAINTS. By J. C. Wall.
 With numerous Illustrations and Plans.

THE ROYAL FORESTS OF ENGLAND. By J.
 C. Cox, LL.D., F.S.A. Illustrated.

THE MANOR AND MANORIAL RECORDS.
 By Nathaniel J. Hone. Illustrated.

ENGLISH SEALS. By J. Harvey Bloom.
 Illustrated.

THE DOMESDAY INQUEST. By Adolphus
 Ballard, B.A., J.L.B. With 27 Illustrations.

THE BRASSES OF ENGLAND. By Herbert
 W. Macklin, M.A. With many Illustrations.
Second Edition.

PARISH LIFE IN MEDIAEVAL ENGLAND. By
 the Right Rev. Abbot Gasquet, O.S.B.
 With many Illustrations. *Second Edition.*

THE BELLS OF ENGLAND. By Canon J. J.
 Raven, D.D., F.S.A. With Illustrations.
Second Edition.

The Arden Shakespeare

Demy 8vo. 2s. 6d. net each volume.

General Editor, W. J. CRAIG.

An edition of Shakespeare in single Plays. Edited with a full Introduction, Textual
 Notes, and a Commentary at the foot of the page.

HAMLET Edited by Edward Dowden.

ROMEO AND JULIET. Edited by Edward
 Dowden.

KING LEAR. Edited by W. J. Craig.

JULIUS CAESAR. Edited by M. Macmillan.

THE TEMPEST. Edited by Moreton Luce.

ARDEN SHAKESPEARE—*continued.*

OTHELLO. Edited by H. C. Hart.
 TITUS ANDRONICUS. Edited by H. B. Baildon.
 CYMBELINE. Edited by Edward Dowden.
 THE MERRY WIVES OF WINDSOR. Edited by H. C. Hart.
 A MIDSUMMER NIGHT'S DREAM. Edited by H. Cuninghame.
 KING HENRY V. Edited by H. A. Evans.
 ALL'S WELL THAT ENDS WELL. Edited by W. O. Brigstocke.
 THE TAMING OF THE SHREW. Edited by R. Warwick Bond.
 TIMON OF ATHENS. Edited by K. Deighton.
 MEASURE FOR MEASURE. Edited by H. C. Hart.
 TWELFTH NIGHT. Edited by Moreton Luce.

THE MERCHANT OF VENICE. Edited by C. Knox Pooler.
 TROILUS AND CRESSIDA. Edited by K. Deighton.
 ANTONY AND CLEOPATRA. Edited by R. H. Case.
 LOVE'S LABOUR'S LOST. Edited by H. C. Hart.
 THE TWO GENTLEMEN OF VERONA. R. Warwick Bond.
 PERICLES. Edited by K. Deighton.
 THE COMEDY OF ERRORS. Edited by H. Cuninghame.
 KING RICHARD III. Edited by A. H. Thompson.
 KING JOHN. Edited by Ivor B. John.

The Beginner's Books

Edited by W. WILLIAMSON, B.A.

EASY FRENCH RHYMES. By Henri Blouet. *Second Edition.* Illustrated. *Fcap. 8vo. 1s.*
 EASY STORIES FROM ENGLISH HISTORY. By E. M. Wilmot-Buxton, Author of 'Makers of Europe.' *Third Edition.* *Cr. 8vo. 1s.*
 EASY EXERCISES IN ARITHMETIC. Arranged by W. S. Beard. *Second Edition.* *Fcap.*

8vo. Without Answers, 1s. With Answers, 1s. 3d.
 EASY DICTATION AND SPELLING. By W. Williamson, B.A. *Fifth Ed. Fcap. 8vo. 1s.*
 AN EASY POETRY BOOK. Selected and arranged by W. Williamson, B.A., Author of 'Dictation Passages.' *Second Edition.* *Cr. 8vo. 1s.*

Books on Business

Cr. 8vo. 2s. 6d. net.

PORTS AND DOCKS. By Douglas Owen.
 RAILWAYS. By E. R. McDermott.
 THE STOCK EXCHANGE. By Chas. Duguid. *Second Edition.*
 THE BUSINESS OF INSURANCE. By A. J. Wilson.
 THE ELECTRICAL INDUSTRY: LIGHTING, TRACTION, AND POWER. By A. G. Whyte, B.Sc.
 THE SHIPBUILDING INDUSTRY: Its History, Science, Practice, and Finance. By David Pollock, M.I.N.A.
 THE MONEY MARKET. By F. Straker.
 THE BUSINESS SIDE OF AGRICULTURE. By A. G. L. Rogers, M.A.
 LAW IN BUSINESS. By H. A. Wilson.
 THE BREWING INDUSTRY. By Julian L. Baker, F.I.C., F.C.S.

THE AUTOMOBILE INDUSTRY. By G. de H. Stone.
 MINING AND MINING INVESTMENTS. By 'A. Moil.'
 THE BUSINESS OF ADVERTISING. By Clarence G. Moran, Barrister-at-Law. Illustrated.
 TRADE UNIONS. By G. Drage.
 CIVIL ENGINEERING. By T. Claxton Fidler, M.Inst. C.E. Illustrated.
 THE IRON TRADE OF GREAT BRITAIN. By J. Stephen Jeans. Illustrated.
 MONOPOLIES, TRUSTS, AND KARTELLS. By F. W. Hirst.
 THE COTTON INDUSTRY AND TRADE. By Prof. S. J. Chapman, Dean of the Faculty of Commerce in the University of Manchester. Illustrated.

Byzantine Texts

Edited by J. B. BURY, M.A., Litt.D.

A series of texts of Byzantine Historians,

edited by English and foreign scholars.

ZACHARIAH OF MITYLENE. Translated by F. J. Hamilton, D.D., and E. W. Brooks. *Demy 8vo. 12s. 6d. net.*

THE HISTORY OF PSELLUS. Edited by C. Sathas. *Demy 8vo. 15s. net.*

ECHEGUS CHRONICA. Edited by Professor Lambros. *Demy 8vo. 7s. 6d. net.*

EVAGRIUS. Edited by Léon Parmentier and M. Bidez. *Demy 8vo. 10s. 6d. net.*

THE CHRONICLE OF MOREA. Edited by John Schmitt. *Demy 8vo. 15s. net.*

The Churchman's Bible

General Editor, J. H. BURN, B.D., F.R.S.E.

Fcap. 8vo. 1s. 6d. net each.

A series of Expositions on the Books of the Bible, which will be of service to the general reader in the practical and devotional study of the Sacred Text.

Each Book is provided with a full and clear Introductory Section, in which is stated what is known or conjectured respecting the date and occasion of the composition of the Book, and any other particulars that may help to elucidate its meaning as a whole. The Exposition is divided into sections of a convenient length, corresponding as far as possible with the divisions of the Church Lectionary. The Translation of the Authorised Version is printed in full, such corrections as are deemed necessary being placed in footnotes.

- | | |
|--|---|
| <p>THE EPISTLE OF ST. PAUL THE APOSTLE TO THE GALATIANS. Edited by A. W. Robinson, M.A. <i>Second Edition.</i></p> <p>ECCLESIASTES. Edited by A. W. Streane, D.D.</p> <p>THE EPISTLE OF ST. PAUL THE APOSTLE TO THE PHILIPPIANS. Edited by C. R. D. Biggs, D.D. <i>Second Edition.</i></p> <p>THE EPISTLE OF ST. JAMES. Edited by H. W. Fulford M.A.</p> | <p>ISAIAH. Edited by W. E. Barnes, D.D. <i>Two Volumes.</i> With Map. <i>2s. net each.</i></p> <p>THE EPISTLE OF ST. PAUL THE APOSTLE TO THE EPHESIANS. Edited by G. H. Whitaker, M.A.</p> <p>THE GOSPEL ACCORDING TO ST. MARK. Edited by J. C. Du Buisson, M.A. <i>2s. 6d. net.</i></p> <p>ST. PAUL'S EPISTLES TO THE COLOSSIANS AND PHILEMON. Edited by H. J. C. Knight, M.A. <i>2s. net.</i></p> |
|--|---|

The Churchman's Library

General Editor, J. H. BURN, B.D., F.R.S.E.

Crown 8vo. 3s. 6d. each.

- | | |
|---|--|
| <p>THE BEGINNINGS OF ENGLISH CHRISTIANITY. By W. E. Collins, M.A. With Map.</p> <p>THE KINGDOM OF HEAVEN HERE AND HERE-AFTER. By Canon Winterbotham, M.A., B.Sc, LL.B.</p> <p>THE WORKMANSHIP OF THE PRAYER BOOK: Its Literary and Liturgical Aspects. By J. Dowden, D.D. <i>Second Edition.</i></p> <p>EVOLUTION. By F. B. Jevons, M.A., Litt.D.</p> | <p>SOME NEW TESTAMENT PROBLEMS. By Arthur Wright, D.D. 6s.</p> <p>THE CHURCHMAN'S INTRODUCTION TO THE OLD TESTAMENT. By A. M. Mackay, B.A.</p> <p>THE CHURCH OF CHRIST. By E. T. Green, M.A. 6s.</p> <p>COMPARATIVE THEOLOGY. By J. A. MacCulloch. 6s.</p> |
|---|--|

Classical Translations

Edited by H. F. FOX, M.A., Fellow and Tutor of Brasenose College, Oxford.

Crown 8vo.

A series of Translations from the Greek and Latin Classics, distinguished by literary excellence as well as by scholarly accuracy.

- | | |
|--|---|
| <p>ÆSCHYLUS—Agamemnon Choephoroe, Eumenides. Translated by Lewis Campbell, LL.D. 5s.</p> <p>CICERO—De Oratore I. Translated by E. N. P. Moor, M.A. 3s. 6d.</p> <p>CICERO—Select Orations (Pro Milone, Pro Mureno, Philippic II., in Catilinam). Translated by H. E. D. Blakiston, M.A. 5s.</p> <p>CICERO—De Natura Deorum. Translated by F. Brooks, M.A. 3s. 6d.</p> <p>CICERO—De Officiis. Translated by G. B. Gardiner, M.A. 2s. 6d.</p> | <p>HORACE—The Odes and Epodes. Translated by A. D. Godley, M.A. 2s.</p> <p>LUCIAN—Six Dialogues (Nigrinus, Icaro-Menippus, The Cock, The Ship, The Parasite, The Lover of Falsehood) Translated by S. T. Irwin, M.A. 3s. 6d.</p> <p>SOPHOCLES—Electra and Ajax. Translated by E. D. A. Morshead, M.A. 2s. 6d.</p> <p>TACITUS—Agricola and Germania. Translated by R. B. Townshend. 2s. 6d.</p> <p>THE SATIRES OF JUVENAL. Translated by S. G. Owen. 2s. 6d.</p> |
|--|---|

Classics of Art

Edited by DR. J. H. W. LAING

THE ART OF THE GREEKS. By H. B. Walters. With 112 Plates and 18 Illustrations in the Text. *Wide Royal 8vo.* 12s. 6d. net.

VELAZQUEZ. By A. de Beruete. With 94 Plates. *Wide Royal 8vo.* 10s. 6d. net.

Commercial Series

Edited by H. DE B. GIBBINS, Litt.D., M.A.

Crown 8vo.

COMMERCIAL EDUCATION IN THEORY AND PRACTICE. By E. E. Whitfield, M.A. 5s.

An introduction to Methuen's Commercial Series treating the question of Commercial Education fully from both the point of view of the teacher and of the parent.

BRITISH COMMERCE AND COLONIES FROM ELIZABETH TO VICTORIA. By H. de B. Gibbins, Litt.D., M.A. *Third Edition.* 2s.

COMMERCIAL EXAMINATION PAPERS. By H. de B. Gibbins, Litt.D., M.A. 1s. 6d.

THE ECONOMICS OF COMMERCE. By H. de B. Gibbins, Litt.D., M.A. *Second Edition.* 1s. 6d.

A GERMAN COMMERCIAL READER. By S. E. Bally. With Vocabulary. 2s.

A COMMERCIAL GEOGRAPHY OF THE BRITISH EMPIRE. By L. W. Lyde, M.A. *Sixth Edition.* 2s.

A COMMERCIAL GEOGRAPHY OF FOREIGN NATIONS. By F. C. Boon, B.A. 2s.

A PRIMER OF BUSINESS. By S. Jackson, M.A. *Third Edition.* 1s. 6d.

COMMERCIAL ARITHMETIC. By F. G. Taylor, M.A. *Fourth Edition.* 1s. 6d.

FRENCH COMMERCIAL CORRESPONDENCE. By S. E. Bally. With Vocabulary. *Third Edition.* 2s.

GERMAN COMMERCIAL CORRESPONDENCE. By S. E. Bally. With Vocabulary. *Second Edition.* 2s. 6d.

A FRENCH COMMERCIAL READER. By S. E. Bally. With Vocabulary. *Second Edition.* 2s.

PRECISE WRITING AND OFFICE CORRESPONDENCE. By J. E. Whitfield, M.A. *Second Edition.* 2s.

A GUIDE TO PROFESSIONS AND BUSINESS. By H. Jones. 1s. 6d.

THE PRINCIPLES OF BOOK-KEEPING BY DOUBLE ENTRY. By J. E. H. M'Allen, M.A. 2s.

COMMERCIAL LAW. By W. Douglas Edwards. *Second Edition.* 2s.

The Connoisseur's Library*Wide Royal 8vo.* 25s. net.

A sumptuous series of 20 books on art, written by experts for collectors, superbly illustrated in photogravure, collotype, and colour. The technical side of the art is duly treated. The first volumes are—

MEZZOTINTS. By Cyril Davenport. With 40 Plates in Photogravure.

PORCELAIN. By Edward Dillon. With 19 Plates in Colour, 20 in Collotype, and 5 in Photogravure.

MINIATURES. By Dudley Heath. With 9 Plates in Colour, 15 in Collotype, and 15 in Photogravure.

IVORIES. By A. Maskell. With 80 Plates in Collotype and Photogravure.

ENGLISH FURNITURE. By F. S. Robinson. With 160 Plates in Collotype and one in Photogravure. *Second Edition.*

EUROPEAN ENAMELS. By Henry H. Cunyng-hame, C.B. With 54 Plates in Collotype and Half-tone and 4 Plates in Colour.

GOLDSMITHS' AND SILVERSMITHS' WORK. By Nelson Dawson. With many Plates in Collotype and a Frontispiece in Photogravure.

ENGLISH COLOURED BOOKS. By Martin Hardie. With 28 Illustrations in Colour and Collotype.

GLASS. By Edward Dillon. With 37 Illustrations in Collotype and 12 in Colour.

The Library of Devotion

With Introductions and (where necessary) Notes.

Small Pott 8vo, cloth, 2s. ; leather, 2s. 6d. net.

THE CONFESSIONS OF ST. AUGUSTINE. Edited by C. Bigg, D.D. *Fifth Edition.*

THE CHRISTIAN YEAR. Edited by Walter Lock, D.D. *Third Edition.*

THE IMITATION OF CHRIST. Edited by C. Bigg, D.D. *Fourth Edition.*

A BOOK OF DEVOTIONS. Edited by J. W. Stanbridge, B.D. *Second Edition.*

THE LIBRARY OF DEVOTION—*continued.*

- LYRA INNOCENTIUM. Edited by Walter Lock, D.D.
 A SERIOUS CALL TO A DEVOUT AND HOLY LIFE. Edited by C. Bigg, D.D. *Fourth Edition.*
 THE TEMPLE. Edited by E. C. S. Gibson, D.D. *Second Edition.*
 A GUIDE TO ETERNITY. Edited by J. W. Stanbridge, B.D.
 THE PSALMS OF DAVID. Edited by B. W. Randolph, D.D.
 LYRA APOSTOLICA. By Cardinal Newman and others. Edited by Canon Scott Holland and Canon H. C. Beeching, M.A.
 THE INNER WAY. By J. Tauler. Edited by A. W. Hutton, M.A.
 THE THOUGHTS OF PASCAL. Edited by C. S. Jerram, M.A.
 ON THE LOVE OF GOD. By St. Francis de Sales. Edited by W. J. Knox-Little, M.A.
 A MANUAL OF CONSOLATION FROM THE SAINTS AND FATHERS. Edited by J. H. Burn, B.D.
 THE SONG OF SONGS. Edited by B. Blaxland, M.A.
 THE DEVOTIONS OF ST. ANSELM. Edited by C. C. J. Webb, M.A.
 GRACE ABOUNDING. By John Bunyan. Edited by S. C. Freer, M.A.
 BISHOP WILSON'S SACRA PRIVATA. Edited by A. E. Burn, B.D.

- LYRA SACRA: A Book of Sacred Verse. Edited by H. C. Beeching, M.A., Canon of Westminster.
 A DAY BOOK FROM THE SAINTS AND FATHERS. Edited by J. H. Burn, B.D.
 HEAVENLY WISDOM. A Selection from the English Mystics. Edited by E. C. Gregory.
 LIGHT, LIFE, and LOVE. A Selection from the German Mystics. Edited by W. R. Inge, M.A.
 AN INTRODUCTION TO THE DEVOUT LIFE. By St. Francis de Sales. Translated and Edited by T. Barns, M.A.
 MANCHESTER AL MONDO: a Contemplation of Death and Immortality. By Henry Montagu, Earl of Manchester. With an Introduction by Elizabeth Waterhouse, Editor of 'A Little Book of Life and Death.'
 THE LITTLE FLOWERS OF THE GLORIOUS MESSER ST. FRANCIS AND OF HIS FRIARS. Done into English by W. Heywood. With an Introduction by A. G. Ferfers Howell.
 THE SPIRITUAL GUIDE, which disentangles the Soul and brings it by the Inward Way to the Fruition of Perfect Contemplation, and the Rich Treasure of Internal Peace. Written by Dr. Michael de Molinos, Priest. Translated from the Italian copy, printed at Venice, 1685. Edited with an Introduction by Kathleen Lyttelton. With a Preface by Canon Scott Holland.

The Illustrated Pocket Library of Plain and Coloured Books

Fcap 8vo. 3s. 6d. net each volume.

A series, in small form, of some of the famous illustrated books of fiction and general literature. These are faithfully reprinted from the first or best editions without introduction or notes. The Illustrations are chiefly in colour.

COLOURED BOOKS

- OLD COLOURED BOOKS. By George Paston. With 16 Coloured Plates. *Fcap. 8vo. 2s. net.*
 THE LIFE AND DEATH OF JOHN MUTTON, ESQ. By Nimrod. With 18 Coloured Plates by Henry Alken and T. J. Rawlins. *Fourth Edition.*
 THE LIFE OF A SPORTSMAN. By Nimrod. With 35 Coloured Plates by Henry Alken.
 HANDLEY CROSS. By R. S. Surtees. With 17 Coloured Plates and 100 Woodcuts in the Text by John Leech. *Second Edition.*
 MR. SPONGE'S SPORTING TOUR. By R. S. Surtees. With 13 Coloured Plates and 90 Woodcuts in the Text by John Leech.
 JORROCKS' JAUNTS AND JOLLITIES. By R. S. Surtees. With 15 Coloured Plates by H. Alken. *Second Edition.*
 This volume is reprinted from the extremely rare and costly edition of 1843, which contains Alken's very fine illustrations instead of the usual ones by Phil.
 ASK MAMMA. By R. S. Surtees. With 13 Coloured Plates and 70 Woodcuts in the Text by John Leech.
 THE ANALYSIS OF THE HUNTING FIELD. By R. S. Surtees. With 7 Coloured Plates by Henry Alken, and 43 Illustrations on Wood.
 THE TOUR OF DR. SYNTAX IN SEARCH OF THE PICTURESQUE. By William Combe. With 30 Coloured Plates by T. Rowlandson.
 THE TOUR OF DOCTOR SYNTAX IN SEARCH OF CONSOLATION. By William Combe. With 24 Coloured Plates by T. Rowlandson.
 THE THIRD TOUR OF DOCTOR SYNTAX IN SEARCH OF A WIFE. By William Combe. With 24 Coloured Plates by T. Rowlandson.
 THE HISTORY OF JOHNNY QUAE GENUS: the Little Foundling of the late Dr. Syntax. By the Author of 'The Three Tours.' With 24 Coloured Plates by Rowlandson.
 THE ENGLISH DANCE OF DEATH, from the Designs of T. Rowlandson, with Metrical Illustrations by the Author of 'Doctor Syntax.' *Two Volumes.*
 This book contains 76 Coloured Plates.
 THE DANCE OF LIFE: A Poem. By the Author of 'Doctor Syntax.' Illustrated with 48 Coloured Engravings by T. Rowlandson.

ILLUSTRATED POCKET LIBRARY OF PLAIN AND COLOURED BOOKS—*continued.*

LIFE IN LONDON: or, the Day and Night Scenes of Jerry Hawthorn, Esq., and his Elegant Friend, Corinthian Tom. By Pierce Egan. With 36 Coloured Plates by I. R. and G. Cruikshank. With numerous Designs on Wood.

REAL LIFE IN LONDON: or, the Rambles and Adventures of Bob Tallyho, Esq., and his Cousin, The Hon. Tom Dashall. By an Amateur (Pierce Egan). With 31 Coloured Plates by Alken and Rowlandson, etc. *Two Volumes.*

THE LIFE OF AN ACTOR. By Pierce Egan. With 27 Coloured Plates by Theodore Lane, and several Designs on Wood.

THE VICAR OF WAKEFIELD. By Oliver Goldsmith. With 24 Coloured Plates by T. Rowlandson.

THE MILITARY ADVENTURES OF JOHNNY NEWCOME. By an Officer. With 15 Coloured Plates by T. Rowlandson.

THE NATIONAL SPORTS OF GREAT BRITAIN. With Descriptions and 51 Coloured Plates by Henry Alken.

This book is completely different from the large folio edition of 'National Sports' by the same artist, and none of the plates are similar.

THE ADVENTURES OF A POST CAPTAIN. By A Naval Officer. With 24 Coloured Plates by Mr. Williams.

GAMONIA: or, the Art of Preserving Game; and an Improved Method of making Plantations and Covers, explained and illustrated by Lawrence Rawstone, Esq. With 15 Coloured Plates by T. Rawlins.

AN ACADEMY FOR GROWN HORSEMEN: Containing the completest Instructions for Walking, Trotting, Cantering, Galloping, Stumbling, and Tumbling. Illustrated with 27 Coloured Plates, and adorned with a Portrait of the Author. By Geoffrey Gambado, Esq.

REAL LIFE IN IRELAND, or, the Day and Night Scenes of Brian Boru, Esq., and his Elegant Friend, Sir Shawn O'Dogherty. By a Real Paddy. With 19 Coloured Plates by Heath, Marks, etc.

THE ADVENTURES OF JOHNNY NEWCOME IN THE NAVY. By Alfred Burton. With 16 Coloured Plates by T. Rowlandson.

THE OLD ENGLISH SQUIRE: A Poem. By John Careless, Esq. With 20 Coloured Plates after the style of T. Rowlandson.

PLAIN BOOKS

THE GRAVE: A Poem. By Robert Blair. Illustrated by 12 Etchings executed by Louis Schiavonetti from the original Inventions of William Blake. With an Engraved Title Page and a Portrait of Blake by T. Phillips, R.A. The illustrations are reproduced in photogravure.

ILLUSTRATIONS OF THE BOOK OF JOB. Invented and engraved by William Blake.

These famous illustrations—21 in number—are reproduced in photogravure.

ÆSOP'S FABLES. With 380 Woodcuts by Thomas Bewick.

WINDSOR CASTLE. By W. Harrison Ainsworth. With 22 Plates and 87 Woodcuts in the Text by George Cruikshank.

THE TOWER OF LONDON. By W. Harrison Ainsworth. With 40 Plates and 58 Woodcuts in the Text by George Cruikshank.

FRANK FAIRLEIGH. By F. E. Smedley. With 30 Plates by George Cruikshank.

HANDY ANDY. By Samuel Lover. With 24 Illustrations by the Author.

THE COMPLEAT ANGLER. By Izaak Walton and Charles Cotton. With 14 Plates and 77 Woodcuts in the Text.

This volume is reproduced from the beautiful edition of John Major of 1824.

THE PICKWICK PAPERS. By Charles Dickens. With the 43 Illustrations by Seymour and Phiz, the two Buss Plates, and the 32 Contemporary Onwhyn Plates.

Junior Examination Series

Edited by A. M. M. STEDMAN, M.A. *Fcap. 8vo. 1s.*

JUNIOR FRENCH EXAMINATION PAPERS. By F. Jacob, M.A. *Second Edition.*

JUNIOR LATIN EXAMINATION PAPERS. By C. G. Bolting, B.A. *Fourth Edition.*

JUNIOR ENGLISH EXAMINATION PAPERS. By W. Williamson, B.A.

JUNIOR ARITHMETIC EXAMINATION PAPERS. By W. S. Beard. *Fourth Edition.*

JUNIOR ALGEBRA EXAMINATION PAPERS. By S. W. Finn, M.A.

JUNIOR GREEK EXAMINATION PAPERS. By T. C. Weatherhead, M.A.

JUNIOR GENERAL INFORMATION EXAMINATION PAPERS. By W. S. Beard.

A KEY TO THE ABOVE. 3s. 6d. net.

JUNIOR GEOGRAPHY EXAMINATION PAPERS. By W. G. Baker, M.A.

JUNIOR GERMAN EXAMINATION PAPERS. By A. Voegelin, M.A.

Junior School-Books

Edited by O. D. INSKIP, LL.D., and W. WILLIAMSON, B.A.

- A CLASS-BOOK OF DICTATION PASSAGES. By W. Williamson, B.A. *Thirteenth Edition.* Cr. 8vo. 1s. 6d.
- THE GOSPEL ACCORDING TO ST. MATTHEW. Edited by E. Wilton South, M.A. With Three Maps. Cr. 8vo. 1s. 6d.
- THE GOSPEL ACCORDING TO ST. MARK. Edited by A. E. Rubie, D.D. With Three Maps. Cr. 8vo. 1s. 6d.
- A JUNIOR ENGLISH GRAMMAR. By W. Williamson, B.A. With numerous passages for parsing and analysis, and a chapter on Essay Writing. *Third Edition.* Cr. 8vo. 2s.
- A JUNIOR CHEMISTRY. By E. A. Tyler, B.A., F.C.S. With 78 Illustrations. *Fourth Edition.* Cr. 8vo. 2s. 6d.
- THE ACTS OF THE APOSTLES. Edited by A. E. Rubie, D.D. Cr. 8vo. 2s.
- A JUNIOR FRENCH GRAMMAR. By L. A. Sornet and M. J. Acatos. *Second Edition.* Cr. 8vo. 2s.
- ELEMENTARY EXPERIMENTAL SCIENCE. PHYSICS by W. T. Clough, A. R. C.S. CHEMISTRY by A. E. Dunstan, B.Sc. With 2 Plates and 154 Diagrams. *Fifth Edition.* Cr. 8vo. 2s. 6d.
- A JUNIOR GEOMETRY. By Noel S. Lydon. With 276 Diagrams. *Fifth Edition.* Cr. 8vo. 2s.
- ELEMENTARY EXPERIMENTAL CHEMISTRY. By A. E. Dunstan, B.Sc. With 4 Plates and 109 Diagrams. *Second Edition.* Cr. 8vo. 2s.
- A JUNIOR FRENCH PROSE. By R. R. N. Baron, M.A. *Second Edition.* Cr. 8vo. 2s.
- THE GOSPEL ACCORDING TO ST. LUKE. With an Introduction and Notes by William Williamson, B.A. With Three Maps. Cr. 8vo. 2s.
- THE FIRST BOOK OF KINGS. Edited by A. E. RUBIE, D.D. With Maps. Cr. 8vo. 2s.

Leaders of Religion

Edited by H. C. BEECHING, M.A., Canon of Westminster. *With Portraits.*

Cr. 8vo. 2s. net.

- CARDINAL NEWMAN. By R. H. Hutton.
- JOHN WESLEY. By J. H. Overton, M.A.
- BISHOP WILBERFORCE. By G. W. Daniell, M.A.
- CARDINAL MANNING. By A. W. Hutton, M.A.
- CHARLES SIMON. By H. C. G. Moule, D.D.
- JOHN KEBLE. By Walter Lock, D.D.
- THOMAS CHALMERS. By Mrs. Oliphant.
- LANCELOT ANDREWES. By R. L. Ottley, D.D. *Second Edition.*
- AUGUSTINE OF CANTERBURY. By E. L. Cutts, D.D.
- WILLIAM LAUD. By W. H. Hutton, M.A. *Third Edition.*
- JOHN KNOX. By F. MacCunn. *Second Edition.*
- JOHN HOWE. By R. F. Horton, D.D.
- BISHOP KEN. By F. A. Clarke, M.A.
- GEORGE FOX, THE QUAKER. By T. Hodgkin, D.C.L. *Third Edition.*
- JOHN DONNE. By Augustus Jessopp, D.D.
- THOMAS CRANMER. By A. J. Mason, D.D.
- BISHOP LATIMER. By R. M. Carlyle and A. J. Carlyle, M.A.
- BISHOP BUTLER. By W. A. Spooner, M.A.

Little Books on Art

With many Illustrations. Demy 16mo. 2s. 6d. net.

A series of monographs in miniature, containing the complete outline of the subject under treatment and rejecting minute details. These books are produced with the greatest care. Each volume consists of about 200 pages, and contains from 30 to 40 illustrations, including a frontispiece in photogravure.

- GREEK ART. H. B. Walters. *Third Edition.*
- BOOKPLATES. E. Almack.
- REYNOLDS. J. Sime. *Second Edition.*
- ROMNEY. George Paston.
- GREUZE AND BOUCHER. Eliza F. Pollard.
- VANDYCK. M. G. Smallwood.
- TURNER. Frances Tyrrell-Gill.
- DÜRER. Jessie Allen.
- HOPFFNER. H. P. K. Skipton.
- HOLBRIN. Mrs. G. Fortescue.
- WATTS. R. E. D. Sketchley.
- LEIGHTON. Alice Corkran.
- VELASQUEZ. Wilfrid Wilberforce and A. R. Gilbert.
- COROT. Alice Pollard and Ethel Birnstingl.
- RAFAEL. A. R. Dryhurst.
- MILLET. Netta Peacock.
- ILLUMINATED MSS. J. W. Bradley.
- CHRIST IN ART. Mrs. Henry Jenner.
- JEWELLERY. Cyril Davenport.

[Continued.]

LITTLE BOOKS ON ART—*continued.*

- | | |
|---|-----------------------------------|
| BURNE-JONES. <i>Fortunée de Lisle.</i> <i>Second Edition.</i> | CLAUDE. Edward Dillon. |
| REMBRANDT. Mrs. E. A. Sharp. | THE ARTS OF JAPAN. Edward Dillon. |
| | ENAMELS. Mrs. Nelson Dawson. |

The Little Galleries*Demy 16mo. 2s. 6d. net.*

A series of little books containing examples of the best work of the great painters. Each volume contains 20 plates in photogravure, together with a short outline of the life and work of the master to whom the book is devoted.

A LITTLE GALLERY OF REYNOLDS.
A LITTLE GALLERY OF ROMNEY.
A LITTLE GALLERY OF HOPFFNER.

A LITTLE GALLERY OF MILLAIS.
A LITTLE GALLERY OF ENGLISH PORTRAITISTS.

The Little Guides

With many Illustrations by E. H. NEW and other artists, and from photographs.

Small Pott 8vo, cloth, 2s. 6d. net.; leather, 3s. 6d. net.

Messrs. METHUEN are publishing a small series of books under the general title of THE LITTLE GUIDES. The main features of these books are (1) a handy and charming form, (2) artistic illustrations by E. H. NEW and others, (3) good plans and maps, (4) an adequate but compact presentation of everything that is interesting in the natural features, history, archæology, and architecture of the town or district treated.

- | | |
|--|---|
| CAMBRIDGE AND ITS COLLEGES. By A. Hamilton Thompson. <i>Second Edition.</i> | HERTFORDSHIRE. By H. W. Tompkins, F.R.H.S. |
| OXFORD AND ITS COLLEGES. By J. Wells, M.A. <i>Seventh Edition.</i> | THE ISLE OF WIGHT. By G. Clinch. |
| ST. PAUL'S CATHEDRAL. By George Clinch. | KENT. By G. Clinch. |
| WESTMINSTER ABBEY. By G. E. Troutbeck. | KERRY. By C. P. Crane. |
| THE ENGLISH LAKES. By F. G. Brabant, M.A. | MIDDLESEX. By John B. Firth. |
| THE MALVERN COUNTRY. By B. C. A. Windle, D.Sc., F.R.S. | NORTHAMPTONSHIRE. By Wakeling Dry. |
| SHAKESPEARE'S COUNTRY. By B. C. A. Windle, D.Sc., F.R.S. <i>Third Edition.</i> | NORFOLK. By W. A. Dutt. |
| BUCKINGHAMSHIRE. By E. S. Roscoe. | OXFORDSHIRE. By F. G. Brabant, M.A. |
| CHESHIRE. By W. M. Gallichan. | SUFFOLK. By W. A. Dutt. |
| CORNWALL. By A. L. Salmon. | SURREY. By F. A. H. Lambert. |
| DERBYSHIRE. By J. Charles Cox, LL.D., F.S.A. | SUSSEX. By F. G. Brabant, M.A. <i>Second Edition.</i> |
| DEVON. By S. Baring-Gould. | THE EAST RIDING OF YORKSHIRE. By J. E. Morris. |
| DORSET. By Frank R. Heath. | THE NORTH RIDING OF YORKSHIRE. By J. E. Morris. |
| HAMPSHIRE. By J. Charles Cox, LL.D., F.S.A. | BRITTANY. By S. Baring-Gould. |
| | NORMANDY. By C. Scudamore. |
| | ROME. By C. G. Ellaby. |
| | SICILY. By F. Hamilton Jackson. |

The Little Library

With Introductions, Notes, and Photogravure Frontispieces.

Small Pott 8vo. Each Volume, cloth, 1s. 6d. net.; leather, 2s. 6d. net.

- | | |
|---|---|
| ANON. ENGLISH LYRICS, A LITTLE BOOK OF. | NORTHANGER ABBEY. Edited by E. V. Lucas. |
| ANSTEN (Jane). PRIDE AND PREJUDICE. Edited by E. V. Lucas. <i>Two Vols.</i> | BACON (Francis). THE ESSAYS OF LORD BACON. Edited by EDWARD WRIGHT. |

Continued.

THE LITTLE LIBRARY—continued.

- Barham (R. H.).** THE INGOLDSBY LEGENDS. Edited by J. B. ATLAY. *Two Volumes.*
- Barnett (Mrs. P. A.).** A LITTLE BOOK OF ENGLISH PROSE.
- Beckford (William).** THE HISTORY OF THE CALIPH VATHEK. Edited by E. DENISON ROSS.
- Blake (William).** SELECTIONS FROM WILLIAM BLAKE. Edited by M. PERUGINI.
- Borrow (George).** LAVENGRO. Edited by F. HINDES GROOME. *Two Volumes.*
- THE ROMANY RYE.** Edited by JOHN SAMPSON.
- Browning (Robert).** SELECTIONS FROM THE EARLY POEMS OF ROBERT BROWNING. Edited by W. HALL GRIFFIN, M.A.
- Canning (George).** SELECTIONS FROM THE ANTI-JACOBIN: with GEORGE CANNING'S additional Poems. Edited by LLOYD SANDERS.
- Cowley (Abraham).** THE ESSAYS OF ABRAHAM COWLEY. Edited by H. C. MINCHIN.
- Crabbe (George).** SELECTIONS FROM GEORGE CRABBE. Edited by A. C. DEANE.
- Crak (Mrs.).** JOHN HALIFAX, GENTLEMAN. Edited by ANNE MATHESON. *Two Volumes.*
- Crashaw (Richard).** THE ENGLISH POEMS OF RICHARD CRASHAW. Edited by EDWARD HUTTON.
- Dante (Alighieri).** THE INFERNO OF DANTE. Translated by H. F. CARY. Edited by PAGET TOYNBEE, M.A., D.Litt.
- THE PURGATORIO OF DANTE.** Translated by H. F. CARY. Edited by PAGET TOYNBEE, M.A., D.Litt.
- THE PARADISO OF DANTE.** Translated by H. F. CARY. Edited by PAGET TOYNBEE, M.A., D.Litt.
- Darley (George).** SELECTIONS FROM THE POEMS OF GEORGE DARLEY. Edited by R. A. STREATFIELD.
- Deane (A. C.).** A LITTLE BOOK OF LIGHT VERSE.
- Dickens (Charles).** CHRISTMAS BOOKS. *Two Volumes.*
- Ferrier (Susan).** MARRIAGE. Edited by A. GOODRICH-FERRER and LORD IDDESLEIGH. *Two Volumes.*
- THE INHERITANCE.** *Two Volumes.*
- Gaskell (Mrs.).** CRANFORD. Edited by E. V. LUCAS. *Second Edition.*
- Hawthorne (Nathaniel).** THE SCARLET LETTER. Edited by PERCY DEARMER.
- Henderson (T. F.).** A LITTLE BOOK OF SCOTTISH VERSE.
- Keats (John).** POEMS. With an Introduction by L. BINYON, and Notes by J. MASEFIELD.
- Kinglake (A. W.).** EOTHEN. With an Introduction and Notes. *Second Edition.*
- Lamb (Charles).** ELIA, AND THE LAST ESSAYS OF ELIA. Edited by E. V. LUCAS.
- Locker (F.).** LONDON LYRICS. Edited by A. D. GODLEY, M.A. A reprint of the First Edition.
- Longfellow (H. W.).** SELECTIONS FROM LONGFELLOW. Edited by L. M. FAITHFULL.
- Marvell (Andrew).** THE POEMS OF ANDREW MARVELL. Edited by E. WRIGHT.
- Milton (John).** THE MINOR POEMS OF JOHN MILTON. Edited by H. C. BEECHING, M.A., Canon of Westminster.
- Moir (D. M.).** MANSIE WAUCH. Edited by T. F. HENDERSON.
- Nichols (J. B. B.).** A LITTLE BOOK OF ENGLISH SONNETS.
- Rochefoucauld (La).** THE MAXIMS OF LA ROCHEFOUCAULD. Translated by Dean STANHOPE. Edited by G. H. POWELL.
- Smith (Horace and James).** REJECTED ADDRESSES. Edited by A. D. GODLEY, M.A.
- Sterne (Laurence).** A SENTIMENTAL JOURNEY. Edited by H. W. PAUL.
- Tennyson (Alfred, Lord).** THE EARLY POEMS OF ALFRED, LORD TENNYSON. Edited by J. CHURTON COLLINS, M.A.
- IN MEMORIAM.** Edited by H. C. BEECHING, M.A.
- THE PRINCESS.** Edited by ELIZABETH WORDSWORTH.
- MAUD.** Edited by ELIZABETH WORDSWORTH.
- Thackeray (W. M.).** VANITY FAIR. Edited by S. GWYNN. *Three Volumes.*
- PENDENNIS.** Edited by S. GWYNN. *Three Volumes.*
- ESMOND.** Edited by S. GWYNN.
- CHRISTMAS BOOKS.** Edited by S. GWYNN.
- Vaughan (Henry).** THE POEMS OF HENRY VAUGHAN. Edited by EDWARD HUTTON.
- Walton (Izaak).** THE COMPLETE ANGLER. Edited by J. BUCHAN.
- Waterhouse (Mrs. Alfred).** A LITTLE BOOK OF LIFE AND DEATH. Edited by *Tenth Edition.*
- Also on Japanese Paper. *Leather. 5s. net.*
- Wordsworth (W.).** SELECTIONS FROM WORDSWORTH. Edited by NOWELL C. SMITH.
- Wordsworth (W.) and Coleridge (S. T.).** LYRICAL BALLADS. Edited by GEORGE SAMPSON.

The Little Quarto Shakespeare

Edited by W. J. CRAIG. With Introductions and Notes

*Pott 16mo. In 40 Volumes. Leather, price 1s. net each volume.
Mahogany Revolving Book Case. 10s. net.*

Miniature Library

Reprints in miniature of a few interesting books which have qualities of humanity, devotion, or literary genius.

- EUPHRANOR: A Dialogue on Youth. By Edward FitzGerald. From the edition published by W. Pickering in 1851. *Demy 32mo. Leather, 2s. net.*
- POLONIUS: or Wise Saws and Modern Instances. By Edward FitzGerald. From the edition published by W. Pickering in 1852. *Demy 32mo. Leather, 2s. net.*
- THE RUBÁIVÁT OF OMAR KHAYYÁM. By Edward FitzGerald. From the 1st edition of 1859, *Fourth Edition. Leather, 1s. net.*
- THE LIFE OF EDWARD, LORD HERBERT OF CHERBURY. Written by himself. From the edition printed at Strawberry Hill in the year 1764. *Demy 32mo. Leather, 2s. net.*
- THE VISIONS OF DOM FRANCISCO QUEVEDO VILLEGAS, Knight of the Order of St. James. Made English by R. L. From the edition printed for H. Herringman, 1668. *Leather. 2s. net.*
- POEMS. By Dora Greenwell. From the edition of 1848. *Leather, 2s. net.*

Oxford Biographies

Fcap. 8vo. Each volume, cloth, 2s. 6d. net; leather, 3s. 6d. net.

- DANTE ALIGHIERI. By Paget Toynbee, M.A., D.Litt. With 12 Illustrations. *Second Edition.*
- SAVONAROLA. By E. L. S. Horsburgh, M.A. With 12 Illustrations. *Second Edition.*
- JOHN HOWARD. By E. C. S. Gibson, D.D., Bishop of Gloucester. With 12 Illustrations.
- TENNYSON. By A. C. Benson, M.A. With 9 Illustrations.
- WALTER RALEIGH. By I. A. Taylor. With 12 Illustrations.
- ERASMUS. By E. F. H. Capey. With 12 Illustrations.
- THE YOUNG PRETENDER. By C. S. Terry. With 12 Illustrations.
- ROBERT BURNS. By T. F. Henderson. With 12 Illustrations.
- CHATHAM. By A. S. M'Dowall. With 12 Illustrations.
- ST. FRANCIS OF ASSISI. By Anna M. Stoddart. With 16 Illustrations.
- CANNING. By W. Alison Phillips. With 12 Illustrations.
- BEACONSFIELD. By Walter Sichel. With 12 Illustrations.
- GOETHE. By H. G. Atkins. With 12 Illustrations.
- FENELON. By Viscount St Cyres. With 12 Illustrations.

School Examination Series

Edited by A. M. M. STEDMAN, M.A. *Cr. 8vo. 2s. 6d.*

- FRENCH EXAMINATION PAPERS. By A. M. M. Stedman, M.A. *Fourteenth Edition.*
A KEY, issued to Tutors and Private Students only to be had on application to the Publishers. *Fifth Edition. Crown 8vo. 6s. net.*
- LATIN EXAMINATION PAPERS. By A. M. M. Stedman, M.A. *Thirteenth Edition.*
KEY (*Sixth Edition*) issued as above. *6s. net.*
- GREEK EXAMINATION PAPERS. By A. M. M. Stedman, M.A. *Ninth Edition.*
KEY (*Fourth Edition*) issued as above. *6s. net.*
- GERMAN EXAMINATION PAPERS. By R. J. Morich. *Sixth Edition.*
- KEY (*Third Edition*) issued as above. *6s. net.*
- HISTORY AND GEOGRAPHY EXAMINATION PAPERS. By C. H. Spence, M.A. *Third Edition.*
- PHYSICS EXAMINATION PAPERS. By R. E. Steel, M.A., F.C.S.
- GENERAL KNOWLEDGE EXAMINATION PAPERS. By A. M. M. Stedman, M.A. *Sixth Edition.*
KEY (*Fourth Edition*) issued as above. *7s. net.*
- EXAMINATION PAPERS IN ENGLISH HISTORY. By J. Tait Plowden-Wardlaw, B.A.

School Histories*Illustrated. Crown 8vo. 1s. 6d.*

- | | |
|---|---|
| A SCHOOL HISTORY OF WARWICKSHIRE. By B. C. A. Windle, D.Sc., F.R.S. | A SCHOOL HISTORY OF SURREY. By H. E. Malden, M.A. |
| A SCHOOL HISTORY OF SOMERSET. By Walter Raymond. <i>Second Edition.</i> | A SCHOOL HISTORY OF MIDDLESEX. By V. G. Plarr and F. W. Walton. |
| A SCHOOL HISTORY OF LANCASHIRE. by W. E. Rhodes. | |

Textbooks of Science

Edited by G. F. GOODCHILD, M.A., B.Sc., and G. R. MILLS, M.A.

- | | |
|---|---|
| PRACTICAL MECHANICS. By Sidney H. Wells. <i>Fourth Edition. Cr. 8vo. 3s. 6d.</i> | THE COMPLETE SCHOOL CHEMISTRY. By F. M. Oldham, B.A. With 126 Illustrations. <i>Cr. 8vo.</i> |
| PRACTICAL CHEMISTRY. Part I. By W. French, M.A. <i>Cr. 8vo. Fourth Edition. 1s. 6d.</i> Part II. By W. French, M.A., and T. H. Boardman, M.A. <i>Cr. 8vo. 1s. 6d.</i> | AN ORGANIC CHEMISTRY FOR SCHOOLS AND TECHNICAL INSTITUTES. By A. E. Dunstan, B.Sc. (Lond.), F.C.S. Illustrated. <i>Cr. 8vo.</i> |
| TECHNICAL ARITHMETIC AND GEOMETRY. By C. T. Mills, M.I.M.E. <i>Cr. 8vo. 3s. 6d.</i> | ELEMENTARY SCIENCE FOR PUPIL TEACHERS. PHYSICS SECTION. By W. T. Clough, A.R.C.S. (Lond.), F.C.S. CHEMISTRY SECTION. By A. E. Dunstan, B.Sc. (Lond.), F.C.S. With 2 Plates and 10 Diagrams. <i>Cr. 8vo. 2s.</i> |
| EXAMPLES IN PHYSICS. By C. E. Jackson, B.A. <i>Cr. 8vo. 2s. 6d.</i> | |
| PLANT LIFE, Studies in Garden and School. By Horace F. Jones, F.C.S. With 320 Diagrams. <i>Cr. 8vo. 3s. 6d.</i> | |

Methuen's Simplified French Texts

Edited by T. R. N. CROFTS, M.A.

One Shilling each.

- | | |
|--|---|
| L'HISTOIRE D'UNE TULIPE. Adapted by T. R. N. Crofts, M.A. <i>Second Edition.</i> | LA CHANSON DE ROLAND. Adapted by H. Rieu, M.A. |
| ABDALLAH. Adapted by J. A. Wilson. | MÉMOIRES DE CADICHON. Adapted by J. F. Rhoades. |

Methuen's Standard Library*In Sixpenny Volumes.*

THE STANDARD LIBRARY is a new series of volumes containing the great classics of the world, and particularly the finest works of English literature. All the great masters will be represented, either in complete works or in selections. It is the ambition of the publishers to place the best books of the Anglo-Saxon race within the reach of every reader, so that the series may represent something of the diversity and splendour of our English tongue. The characteristics of THE STANDARD LIBRARY are four:—1. SOUNDNESS OF TEXT. 2. CHEAPNESS. 3. CLEARNESS OF TYPE. 4. SIMPLICITY. The books are well printed on good paper at a price which on the whole is without parallel in the history of publishing. Each volume contains from 100 to 250 pages, and is issued in paper covers, Crown 8vo, at Sixpence net, or in cloth gilt at One Shilling net. In a few cases long books are issued as Double Volumes or as Treble Volumes.

- | | |
|--|---|
| THE MEDITATIONS OF MARCUS AURELIUS. The translation is by R. Graves. | THE PILGRIM'S PROGRESS. By John Bunyan. |
| SENSE AND SENSIBILITY. By Jane Austen. | REFLECTIONS ON THE FRENCH REVOLUTION. By Edmund Burke. |
| ESSAYS AND COUNSELS AND THE NEW ATLANTIS. By Francis Bacon, Lord Verulam. | THE POEMS AND SONGS OF ROBERT BURNS. Double Volume. |
| RELIGIO MEDICI and URN BURIAL. By Sir Thomas Browne. The text has been collated by A. R. Waller. | THE ANALOGY OF RELIGION, NATURAL AND REVEALED. By Joseph Butler, D.D. |
| | THE POEMS OF THOMAS CHATTERTON, In 2 volumes. |
| | Vol. I.—Miscellaneous Poems. |

METHUEN'S STANDARD LIBRARY—continued.

- VOL. II.—The Rowley Poems.**
THE NEW LIFE AND SONNETS. By Dante. Translated into English by D. G. Rossetti.
TOM JONES. By Henry Fielding. Treble Vol. CRANFORD. By Mrs. Gaskell.
THE HISTORY OF THE DECLINE AND FALL OF THE ROMAN EMPIRE. By Edward Gibbon. In 7 double volumes.
 The Text and Notes have been revised by J. B. Bury, Litt.D., but the Appendices of the more expensive edition are not given.
THE VICAR OF WAKEFIELD. By Oliver Goldsmith.
THE POEMS AND PLAYS OF OLIVER GOLDSMITH. THE WORKS OF BEN JONSON.
VOL. I.—The Case is Altered. Every Man in His Humour. Every Man out of His Humour.
VOL. II.—Cynthia's Revels; The Poetaster. The text has been collated by H. C. Hart.
THE POEMS OF JOHN KEATS. Double volume. The Text has been collated by E. de Selincourt.
ON THE IMITATION OF CHRIST. By Thomas à Kempis.
 The translation is by C. Bigg, DD., Canon of Christ Church.
A SERIOUS CALL TO A DEVOUT AND HOLY LIFE. By William Law.
PARADISE LOST. By John Milton.
EIKONOKLASTES AND THE TENURE OF KINGS AND MAGISTRATES. By John Milton.
UTOPIA AND POEMS. By Sir Thomas More.
THE REPUBLIC OF PLATO. Translated by

- Sydenham and Taylor. Double Volume. The translation has been revised by W. H. D. Rouse.
THE LITTLE FLOWERS OF ST. FRANCIS. Translated by W. Heywood.
THE WORKS OF WILLIAM SHAKESPEARE. In 10 volumes.
VOL. I.—The Tempest; The Two Gentlemen of Verona; The Merry Wives of Windsor; Measure for Measure; The Comedy of Errors.
VOL. II.—Much Ado About Nothing; Love's Labour's Lost; A Midsummer Night's Dream; The Merchant of Venice; As You Like It.
VOL. III.—The Taming of the Shrew; All's Well that Ends Well; Twelfth Night; The Winter's Tale.
VOL. IV.—The Life and Death of King John; The Tragedy of King Richard the Second; The First Part of King Henry iv.; The Second Part of King Henry iv.
VOL. V.—The Life of King Henry v.; The First Part of King Henry vi.; The Second Part of King Henry vi.
VOL. VI.—The Third Part of King Henry vi.; The Tragedy of King Richard III.; The Famous History of the Life of King Henry VIII.
THE POEMS OF PERCY BYSSHE SHELLEY. In 4 volumes.
VOL. I.—Alastor; The Dæmon of the World; The Revolt of Islam, etc.
 The Text has been revised by C. D. Locock.
THE LIFE OF NELSON. By Robert Southey.
THE NATURAL HISTORY AND ANTIQUITIES OF SELBORNE. By Gilbert White.

Textbooks of Technology

Edited by G. F. GOODCHILD, M.A., B.Sc., and G. R. MILLS, M.A.

Fully Illustrated.

- HOW TO MAKE A DRESS.** By J. A. E. Wood. *Fourth Edition. Cr. 8vo. 1s. 6d.*
CARPENTRY AND JOINERY. By F. C. Webber. *Fifth Edition. Cr. 8vo. 3s. 6d.*
MILLINERY, THEORETICAL AND PRACTICAL. By Clara Hill. *Third Edition. Cr. 8vo. 2s.*
AN INTRODUCTION TO THE STUDY OF TEXTILE DESIGN. By Aldred F. Barker. *Demy 8vo. 7s. 6d.*
BUILDERS' QUANTITIES. By H. C. Grubb. *Cr. 8vo. 4s. 6d.*
RÉPOUSSÉ METAL WORK. By A. C. Horth. *Cr. 8vo. 2s. 6d.*
ELECTRIC LIGHT AND POWER: An Introduction to the Study of Electrical Engineering. By E. E. Brooks, B.Sc. (Lond.) Second Master and Instructor of Physics and Electrical Engineering, Leicester Technical School, and W. H. N. James, A.R.C.S., A.I.E.E., Assistant Instructor of Electrical Engineering, Manchester Municipal Technical School. *Cr. 8vo. 4s. 6d.*
ENGINEERING WORKSHOP PRACTICE. By C. C. Allen, Lecturer on Engineering, Municipal Technical Institute, Coventry. With many Diagrams. *Cr. 8vo. 2s.*

Handbooks of Theology

Edited by R. L. OTTLEY, D.D., Professor of Pastoral Theology at Oxford, and Canon of Christ Church, Oxford.

The series is intended, in part, to furnish the clergy and teachers or students of Theology with trustworthy Textbooks, adequately representing the present position

of the questions dealt with; in part, to make accessible to the reading public an accurate and concise statement of facts and principles in all questions bearing on Theology and Religion.

- THE XXXIX. ARTICLES OF THE CHURCH OF ENGLAND. Edited by E. C. S. Gibson, D.D. *Fifth and Cheaper Edition in one Volume. Demy 8vo. 12s. 6d.*
- AN INTRODUCTION TO THE HISTORY OF RELIGION. By F. B. Jevons, M.A., Litt.D. *Third Edition. Demy 8vo. 10s. 6d.*
- THE DOCTRINE OF THE INCARNATION. By R. L. Ottley, D.D. *Second and Cheaper Edition. Demy 8vo. 12s. 6d.*
- AN INTRODUCTION TO THE HISTORY OF THE CREEDS. By A. E. Burn, D.D. *Demy 8vo. 10s. 6d.*
- THE PHILOSOPHY OF RELIGION IN ENGLAND AND AMERICA. By Alfred Caldecott, D.D. *Demy 8vo. 10s. 6d.*
- A HISTORY OF EARLY CHRISTIAN DOCTRINE. By J. F. Bethune-Baker, M.A. *Demy 8vo. 10s. 6d.*

The Westminster Commentaries

General Editor, WALTER LOCK, D.D., Warden of Keble College,
Dean Ireland's Professor of Exegesis in the University of Oxford.

The object of each commentary is primarily exegetical, to interpret the author's meaning to the present generation. The editors will not deal, except very sub-ordinately, with questions of textual criticism or philology; but, taking the English text in the Revised Version as their basis, they will try to combine a hearty acceptance of critical principles with loyalty to the Catholic Faith.

- THE BOOK OF GENESIS. Edited with Introduction and Notes by S. R. Driver, D.D. *Sixth Edition. Demy 8vo. 10s. 6d.*
- THE BOOK OF JON. Edited by E. C. S. Gibson, D.D. *Second Edition. Demy 8vo. 6s.*
- THE ACTS OF THE APOSTLES. Edited by R. B. Rackham, M.A. *Demy 8vo. Third Edition. 10s. 6d.*
- THE FIRST EPISTLE OF PAUL THE APOSTLE TO THE CORINTHIANS. Edited by H. L. Goudge, M.A. *Demy 8vo. 6s.*
- THE EPISTLE OF ST. JAMES. Edited with Introduction and Notes by R. J. Knowling, D.D. *Demy 8vo. 6s.*
- THE BOOK OF EZEKIEL. Edited H. A. Redpath, M.A., D.Litt. *Demy 8vo. 10s. 6d.*

PART II.—FICTION

- Adderley (Hon. and Rev. James), Author of 'Stephen Remark.' BEHOLD THE DAYS COME. *Second Edition. Cr. 8vo. 3s. 6d.*
- Albanesi (E. Maria). SUSANNAH AND ONE OTHER. *Fourth Edition. Cr. 8vo. 6s.*
- THE BLUNDER OF AN INNOCENT. *Second Edition. Cr. 8vo. 6s.*
- CAPRICIOUS CAROLINE. *Second Edition. Cr. 8vo. 6s.*
- LOVE AND LOUISA. *Second Edition. Cr. 8vo. 6s.*
- PETER, A PARASITE. *Cr. 8vo. 6s.*
- THE BROWN EYES OF MARY. *Third Edition. Cr. 8vo. 6s.*
- I KNOW A MAIDEN. *Third Edition. Cr. 8vo. 6s.*
- Anstey (F.). Author of 'Vice Versa.' A BAYARD FROM BENGAL. Illustrated by BERNARD PARTRIDGE. *Third Edition. Cr. 8vo. 3s. 6d.*
- Bagot (Richard). A ROMAN MYSTERY. *Third Edition. Cr. 8vo. 6s.*
- THE PASSPORT. *Fourth Edition. Cr. 8vo. 6s.*
- TEMPTATION. *Fifth Edition. Cr. 8vo. 6s.*
- CASTING OF NETS. *Twelfth Edition. Cr. 8vo. 6s.*
- DONNA DIANA. *A New Edition. Cr. 8vo. 6s.*
- LOVE'S PROXY. *A New Edition. Cr. 8vo. 6s.*
- Baring-Gould (S.). ARMINELL. *Fifth Edition. Cr. 8vo. 6s.*
- URITH. *Fifth Edition. Cr. 8vo. 6s.*
- IN THE ROAR OF THE SEA. *Seventh Edition. Cr. 8vo. 6s.*
- CHEAP JACK ZITA. *Fourth Edition. Cr. 8vo. 6s.*
- MARGERY OF QUETHER. *Third Edition. Cr. 8vo. 6s.*
- THE QUEEN OF LOVE. *Fifth Edition. Cr. 8vo. 6s.*
- JACQUETTA. *Third Edition. Cr. 8vo. 6s.*
- KITTY ALONE. *Fifth Edition. Cr. 8vo. 6s.*
- NOËMI. Illustrated. *Fourth Edition. Cr. 8vo. 6s.*
- THE BROOM-SQUIRE. Illustrated. *Fifth Edition. Cr. 8vo. 6s.*
- DARTMOOR IDYLLS. *Cr. 8vo. 6s.*
- THE PENNYCOMEQUICKS. *Third Edition. Cr. 8vo. 6s.*
- GUAVAS THE TINNER. Illustrated. *Second Edition. Cr. 8vo. 6s.*

- BLADYS OF THE STEWPONEY.** Illustrated. *Second Edition.* Cr. 8vo. 6s.
- PABO THE PRIEST.** Cr. 8vo. 6s.
- WINEFRED.** Illustrated. *Second Edition.* Cr. 8vo. 6s.
- ROYAL GEORGIE.** Illustrated. Cr. 8vo. 6s.
- MISS QUILLET.** Illustrated. Cr. 8vo. 6s.
- CHRIS OF ALL SORTS.** Cr. 8vo. 6s.
- IN DEWISLAND.** *Second Ed.* Cr. 8vo. 6s.
- LITTLE TUPPENNY.** *A New Edition.* 6d.
See also Shilling Novels.
- Barnett (Edith A.).** A WILDERNESS WINNER. *Second Edition.* Cr. 8vo. 6s.
- Barr (James).** LAUGHING THROUGH A WILDERNESS. Cr. 8vo. 6s.
- Barr (Robert).** IN THE MIDST OF ALARMS. *Third Edition.* Cr. 8vo. 6s.
- THE STRONG ARM.** *Second Edition.* Cr. 8vo. 6s.
- THE MUTABLE MANY.** *Third Edition.* Cr. 8vo. 6s.
- THE COUNTESS TEKLA.** *Fourth Edition.* Cr. 8vo. 6s.
- THE LADY ELECTRA.** *Second Edition.* Cr. 8vo. 6s.
- THE TEMPESTUOUS PETTICOAT.** Illustrated. *Third Edition.* Cr. 8vo. 6s.
See also Shilling Novels and S. Crane.
- Begbie (Harold).** THE ADVENTURES OF SIR JOHN SPARROW. Cr. 8vo. 6s.
- Belloc (Hilaire).** EMMANUEL BURDEN, MERCHANT. With 36 Illustrations by G. K. CHESTERTON. *Second Ed.* Cr. 8vo. 6s.
- Benson (E. F.).** DODO. *Fifteenth Edition.* Cr. 8vo. 6s.
See also Shilling Novels.
- THE CAPSINA.** *Second Edit.* Cr. 8vo. 6s.
- Benson (Margaret).** SUBJECT TO VANITY. Cr. 8vo. 3s. 6d.
- Bretherton (Ralph).** THE MILL. Cr. 8vo. 6s.
- Burke (Barbara).** BARBARA GOES TO OXFORD. *Second Edition.*
- Burton (J. Bloundelle).** THE FATE OF VALSEC. Cr. 8vo. 6s.
See also Shilling Novels.
- Capes (Bernard).** Author of 'The Lake of Wine.' THE EXTRAORDINARY CONFESSIONS OF DIANA PLEASE. *Third Edition.* Cr. 8vo. 6s.
- A JAY OF ITALY.** *Fourth Ed.* Cr. 8vo. 6s.
- LOAVES AND FISHES.** *Second Edition.* Cr. 8vo. 6s.
- A ROGUE'S TRAGEDY.** *Second Edition.* Cr. 8vo. 6s.
- THE GREAT SKENE MYSTERY.** *Second Edition.* Cr. 8vo. 6s.
- Charlton (Randall).** MAVE. *Second Edition.* Cr. 8vo. 6s.
- Carey (Wymond).** LOVE THE JUDGE. *Second Edition.* Cr. 8vo. 6s.
- Chesney (Weatherby).** THE TRAGEDY OF THE GREAT EMERALD. Cr. 8vo. 6s.
- THE MYSTERY OF A BUNGALOW.** *Second Edition.* Cr. 8vo. 6s.
See also Shilling Novels.
- Conrad (Joseph).** THE SECRET AGENT. *Second Edition.* Cr. 8vo. 6s.
- Corelli (Marie).** A ROMANCE OF TWO WORLDS. *Twenty-Eighth Ed.* Cr. 8vo. 6s.
- VENDETTA.** *Twenty-Fifth Edition.* Cr. 8vo. 6s.
- THELMA.** *Thirty-Seventh Ed.* Cr. 8vo. 6s.
- ARDATH: THE STORY OF A DEAD SELF.** *Eighteenth Edition.* Cr. 8vo. 6s.
- THE SOUL OF LILITH.** *Fifteenth Edition.* Cr. 8vo. 6s.
- WORMWOOD.** *Fifteenth Ed.* Cr. 8vo. 6s.
- BARABBAS: A DREAM OF THE WORLD'S TRAGEDY.** *Forty-second Edition.* Cr. 8vo. 6s.
- THE SORROWS OF SATAN.** *Fifty-second Edition.* Cr. 8vo. 6s.
- THE MASTER CHRISTIAN.** *Tenth Edition.* Cr. 8vo. 6s.
- TEMPORAL POWER: A STUDY IN SUPREMACY.** *150th Thousand.* Cr. 8vo. 6s.
- GOD'S GOOD MAN: A SIMPLE LOVE STORY.** *Twelfth Edition.* Cr. 8vo. 6s.
- THE MIGHTY ATOM.** *Twenty-sixth Edition.* Cr. 8vo. 6s.
- BOY.** a Sketch. *Tenth Edition.* Cr. 8vo. 6s.
- CAMEOS.** *Twelfth Edition.* Cr. 8vo. 6s.
- Cotes (Mrs. Everard).** See Sara Jeannette Duncan.
- Cotterell (Constance).** THE VIRGIN AND THE SCALES. Illustrated. *Second Edition.* Cr. 8vo. 6s.
- Crane (Stephen) and Barr (Robert).** THE O'RUDDY. Cr. 8vo. 6s.
- Crockett (S. R.).** Author of 'The Raiders,' etc. LOCHINVAR. Illustrated. *Third Edition.* Cr. 8vo. 6s.
- THE STANDARD BEARER.** Cr. 8vo. 6s.
- Croker (B. M.).** THE OLD CANTONMENT. Cr. 8vo. 6s.
- JOHANNA.** *Second Edition.* Cr. 8vo. 6s.
- THE HAPPY VALLEY.** *Third Edition.* Cr. 8vo. 6s.
- A NINE DAYS' WONDER.** *Third Edition.* Cr. 8vo. 6s.
- PEGGY OF THE BARTONS.** *Sixth Edition.* Cr. 8vo. 6s.
- ANGEL.** *Fourth Edition.* Cr. 8vo. 6s.
- A STATE SECRET.** *Third Edition.* Cr. 8vo. 3s. 6d.
- Crosbie (Mary).** DISCIPLES. *Second Ed.* Cr. 8vo. 6s.
- Dawson (A. J.).** DANIEL WHYTE. Cr. 8vo. 3s. 6d.
- Deane (Mary).** THE OTHER PAWN. Cr. 8vo. 6s.
- Doyle (A. Conan).** Author of 'Sherlock Holmes,' 'The White Company,' etc. ROUND THE RED LAMP. *Tenth Edition.* Cr. 8vo. 6s.
- Duncan (Sara Jeannette) (Mrs. Everard Cotes).** THOSE DELIGHTFUL AMERICANS. Illustrated. *Third Edition.* Cr. 8vo. 6s. See also Shilling Novels.
- Findlater (J. H.).** THE GREEN GRAVES OF BALGOWRIE. *Fifth Edition.* Cr. 8vo. 6s.

- THE LADDER TO THE STARS. *Second Edition. Cr. 8vo. 6s.*
See also Shilling Novels.
- Findlater (Mary).** A NARROW WAY. *Third Edition. Cr. 8vo. 6s.*
- THE ROSE OF JOY. *Third Edition. Cr. 8vo. 6s.*
- A BLIND BIRD'S NEST. With 8 Illustrations. *Second Edition. Cr. 8vo. 6s.*
See also Shilling Novels.
- Fitzpatrick (K.)** THE WEANS AT ROWALLAN. Illustrated. *Second Edition. Cr. 8vo. 6s.*
- Francis (M. L.).** STEPPING WESTWARD. *Second Edition. Cr. 8vo. 6s.*
- Margery O' THE MILL.** *Second Edition. Cr. 8vo. 6s.*
- Fraser (Mrs. Hugh).** Author of 'The Stolen Emperor.' THE SLAKING OF THE SWORD. *Cr. 8vo. 6s.*
- IN THE SHADOW OF THE LORD. *Third Edition. Crown 8vo. 6s.*
- Fry (B. and C. B.).** A MOTHER'S SON. *Fourth Edition. Cr. 8vo. 6s.*
- Fuller-Maitland (Ella).** Author of 'The Day Book of Bethia Hardacre.' BLANCHE ESMEAD. *Second Edition. Cr. 8vo. 6s.*
- Gates (Eleanor).** Author of 'The Biography of a Prairie Girl.' THE PLOW-WOMAN. *Cr. 8vo. 6s.*
- Gerard (Dorothea).** Author of 'Lady Baby.' HOLY MATRIMONY. *Second Edition. Cr. 8vo. 6s.*
- MADE OF MONEY. *Cr. 8vo. 6s.*
- THE BRIDGE OF LIFE. *Cr. 8vo. 6s.*
- THE IMPROBABLE IDYL. *Third Edition. Cr. 8vo. 6s.*
See also Shilling Novels.
- Gissing (George).** Author of 'Demos,' 'In the Year of Jubilee,' etc. THE TOWN TRAVELLER. *Second Ed. Cr. 8vo. 6s.*
- THE CROWN OF LIFE. *Cr. 8vo. 6s.*
- Gleig (Charles).** BUNTER'S CRUISE. Illustrated. *Cr. 8vo. 3s. 6d.*
- Hamilton (M.).** Author of 'Cut Laurels.' THE FIRST CLAIM. *Second Edition. Cr. 8vo. 6s.*
- Harraden (Beatrice).** IN VARYING MOODS. *Fourteenth Edition. Cr. 8vo. 6s.*
- HILDA STRAFFORD AND THE REMITANCE MAN. *Twelfth Ed. Cr. 8vo. 6s.*
- THE SCHOLAR'S DAUGHTER. *Fourth Edition. Cr. 8vo. 6s.*
- Harrod (F.) (Frances Forbes Robertson).** THE TAMING OF THE BRUTE. *Cr. 8vo. 6s.*
- Herbertson (Agnes G.).** PATIENCE DEAN. *Cr. 8vo. 6s.*
- Hichens (Robert).** THE PROPHET OF BERKELEY SQUARE. *Second Edition. Cr. 8vo. 6s.*
- TONGUES OF CONSCIENCE. *Third Edition. Cr. 8vo. 6s.*
- FELIX. *Fifth Edition. Cr. 8vo. 6s.*
- THE WOMAN WITH THE FAN. *Sixth Edition. Cr. 8vo. 6s.*
- REVIEWS. *Cr. 8vo. 6s.*
- THE GARDEN OF ALLAH. *Sixteenth Edition. Cr. 8vo. 6s.*
- THE BLACK SPANIEL. *Cr. 8vo. 6s.*
- THE CALL OF THE BLOOD. *Seventh Edition. Cr. 8vo. 6s.*
- Hope (Anthony).** THE GOD IN THE CAR. *Tenth Edition. Cr. 8vo. 6s.*
- A CHANGE OF AIR. *Sixth Ed. Cr. 8vo. 6s.*
- A MAN OF MARK. *Fifth Ed. Cr. 8vo. 6s.*
- THE CHRONICLES OF COUNT ANTONIO. *Sixth Edition. Cr. 8vo. 6s.*
- PHROSO. Illustrated by H. K. MILLAR. *Sixth Edition. Cr. 8vo. 6s.*
- SIMON DALE. Illustrated. *Seventh Edition. Cr. 8vo. 6s.*
- THE KING'S MIRROR. *Fourth Edition. Cr. 8vo. 6s.*
- QUISANTE. *Fourth Edition. Cr. 8vo. 6s.*
- THE DOLLY DIALOGUES. *Cr. 8vo. 6s.*
- A SERVANT OF THE PUBLIC. Illustrated. *Fourth Edition. Cr. 8vo. 6s.*
- TALES OF TWO PEOPLE. *Second Ed. Cr. 8vo. 6s.*
- Hope (Graham).** Author of 'A Cardinal and his Conscience,' etc. THE LADY OF LYTE. *Second Edition. Cr. 8vo. 6s.*
- Housman (Clemence).** THE LIFE OF SIR AGLOVALE DE GALIS. *Cr. 8vo. 6s.*
- Hueffer (Ford Madox).** AN ENGLISH GIRL. *Second Edition. Cr. 8vo. 6s.*
- Hyne (C. J. Cutcliffe).** Author of 'Captain Kettle.' MR. HORROCKS, PURSER. *Fourth Edition. Cr. 8vo. 6s.*
- PRINCE RUPERT, THE BUCCANEER. Illustrated. *Third Edition. Cr. 8vo. 6s.*
- Jacobs (W. W.).** MANY CARGOES. *Twenty-Ninth Edition. Cr. 8vo. 3s. 6d.*
- SEA URCHINS. *Fourteenth Edition. Cr. 8vo. 3s. 6d.*
- A MASTER OF CRAFT. Illustrated. *Seventh Edition. Cr. 8vo. 3s. 6d.*
- LIGHT FREIGHTS. Illustrated. *Sixth Edition. Cr. 8vo. 3s. 6d.*
- THE SKIPPER'S WOOING. *Eighth Edition. Cr. 8vo. 3s. 6d.*
- DIALSTONE LANE. Illustrated. *Seventh Edition. Cr. 8vo. 3s. 6d.*
- ODD CRAFT. Illustrated. *Seventh Edition. Cr. 8vo. 3s. 6d.*
- AT SUNWICH PORT. Illustrated. *Seventh Edition. Cr. 8vo. 3s. 6d.*
- James (Henry).** THE SOFT SIDE. *Second Edition. Cr. 8vo. 6s.*
- THE BETTER SORT. *Cr. 8vo. 6s.*
- THE AMBASSADORS. *Second Edition. Cr. 8vo. 6s.*
- THE GOLDEN BOWL. *Third Edition. Cr. 8vo. 6s.*
- Keays (H. A. Mitchell).** HE THAT EATETH BREAD WITH ME. *Cr. 8vo. 6s.*
- Kester (Vaughan).** THE FORTUNES OF THE LANDRAYS. *Cr. 8vo. 6s.*
- Lawless (Hon. Emily).** WITH ESSEX IN IRELAND. *Cr. 8vo. 6s.*
See also Shilling Novels.
- Le Queux (W.).** THE HUNCHBACK OF WESTMINSTER. *Third Ed. Cr. 8vo. 6s.*
- THE CLOSED BOOK. *Third Ed. Cr. 8vo. 6s.*

THE VALLEY OF THE SHADOW. Illustrated. *Third Edition.* Cr. 8vo. 6s.
BEHIND THE THRONE. *Third Edition.* Cr. 8vo. 6s.
Levett-Yeats (S.), ORRAIN. *Second Edition.* Cr. 8vo. 6s.
London (Jack), Author of 'The Call of the Wild,' 'The Sea Wolf,' etc. **WHITE FANG.** *Fourth Edition.* Cr. 8vo. 6s.
Lucas (E. V.), LISTENER'S LURE: An Oblique Narration. *Crown 8vo. Fourth Edition.* Cr. 8vo. 6s.
Lyall (Edna), DERRICK VAUGHAN, NOVELIST. *2nd Thousand.* Cr. 8vo. 3s. 6d.
M'Carthy (Justin H.), Author of 'If I were King.' **THE LADY OF LOYALTY HOUSE.** Illustrated. *Third Edition.* Cr. 8vo. 6s.
THE DRYAD. *Second Edition.* Cr. 8vo. 6s.
Macdonald (Ronald), THE SEA MAID. *Second Edition.* Cr. 8vo. 6s.
A HUMAN TRINITY. *Second Edition.* Cr. 8vo. 6s.
Macnaughtan (S.), THE FORTUNE OF CHRISTINA MACNAB. *Fourth Edition.* Cr. 8vo. 6s.
Malet (Lucas), COLONEL ENDERBY'S WIFE. *Fourth Edition.* Cr. 8vo. 6s.
A COUNSEL OF PERFECTION. *New Edition.* Cr. 8vo. 6s.
THE WAGES OF SIN. *Fifteenth Edition.* Cr. 8vo. 6s.
THE CARISSIMA. *Fifth Ed.* Cr. 8vo. 6s.
THE GATELESS BARRIER. *Fourth Edition.* Cr. 8vo. 6s.
THE HISTORY OF SIR RICHARD CALMADY. *Seventh Edition.* Cr. 8vo. 6s.
 See also Books for Boys and Girls.
Mann (Mrs. M. E.), OLIVIA'S SUMMER. *Second Edition.* Cr. 8vo. 6s.
A LOST ESTATE. *A New Ed.* Cr. 8vo. 6s.
THE PARISH OF HILBY. *A New Edition.* Cr. 8vo. 6s.
THE PARISH NURSE. *Fourth Edition.* Cr. 8vo. 6s.
GRAN'MA'S JANE. Cr. 8vo. 6s.
MRS. PETER HOWARD. Cr. 8vo. 6s.
A WINTER'S TALE. *A New Edition.* Cr. 8vo. 6s.
ONE ANOTHER'S BURDENS. *A New Edition.* Cr. 8vo. 6s.
ROSE AT HONEYPOT. *Third Ed.* Cr. 8vo. 6s. See also Books for Boys and Girls.
THE MEMORIES OF RONALD LOVE. Cr. 8vo. 6s.
THE EGLAMORE PORTRAITS. *Third Edition.* Cr. 8vo. 6s.
THE SHEEP AND THE GOATS. *Second Edition.* Cr. 8vo. 6s.
Marriott (Charles), Author of 'The Column.' **GENEVRA.** *Second Edition.* Cr. 8vo. 6s.
Marsh (Richard), THE TWICKENHAM PEERAGE. *Second Edition.* Cr. 8vo. 6s.
THE MARQUIS OF PUTNEY. *Second Edition.* Cr. 8vo. 6s.
A DUEL. Cr. 8vo. 6s.

IN THE SERVICE OF LOVE. *Third Edition.* Cr. 8vo. 6s.
THE GIRL AND THE MIRACLE. *Second Edition.* Cr. 8vo. 6s.
 See also Shilling Novels.
Mason (A. E. W.), Author of 'The Four Feathers,' etc. **CLEMENTINA.** Illustrated. *Second Edition.* Cr. 8vo. 6s.
Mathers (Helen), Author of 'Comin' thro' the Rye.' **HONEY.** *Fourth Ed.* Cr. 8vo. 6s.
GRIFF OF GRIFFITHSCOURT. Cr. 8vo. 6s.
THE FERRYMAN. *Second Edition.* Cr. 8vo. 6s.
TALLY-HO! *Fourth Edition.* Cr. 8vo. 6s.
Maxwell (W. B.), Author of 'The Ragged Messenger.' **VIVIEN.** *Ninth Edition.* Cr. 8vo. 6s.
THE RAGGED MESSENGER. *Third Edition.* Cr. 8vo. 6s.
FABULOUS FANCIES. Cr. 8vo. 6s.
THE GUARDED FLAME. *Seventh Edition.* Cr. 8vo. 6s.
THE COUNTESS OF MAYBURY. *Fourth Edition.* Cr. 8vo. 6s.
ODD LENGTHS. *Second Ed.* Cr. 8vo. 6s.
Meade (L. T.), DRIFT. *Second Edition.* Cr. 8vo. 6s.
RESURGAM. Cr. 8vo. 6s.
VICTORY. Cr. 8vo. 6s.
 See also Books for Boys and Girls.
Melton (R.), CÆSAR'S WIFE. *Second Edition.* Cr. 8vo. 6s.
Meredith (Ellis), HEART OF MY HEART. Cr. 8vo. 6s.
Miller (Esther), LIVING LIES. *Third Edition.* Cr. 8vo. 6s.
'Miss Molly' (The Author of), **THE GREAT RECONCILER.** Cr. 8vo. 6s.
Mitford (Bertram), THE SIGN OF THE SPIDER. Illustrated. *Sixth Edition.* Cr. 8vo. 3s. 6d.
IN THE WHIRL OF THE RISING. *Third Edition.* Cr. 8vo. 6s.
THE RED DERELICT. *Second Edition.* Cr. 8vo. 6s.
Montresor (F. F.), Author of 'Into the Highways and Hedges.' **THE ALIEN.** *Third Edition.* Cr. 8vo. 6s.
Morrison (Arthur), TALES OF MEAN STREETS. *Seventh Edition.* Cr. 8vo. 6s.
A CHILD OF THE JAGO. *Fifth Edition.* Cr. 8vo. 6s.
TO LONDON TOWN. *Second Edition.* Cr. 8vo. 6s.
CUNNING MURRELL. Cr. 8vo. 6s.
THE HOLE IN THE WALL. *Fourth Edition.* Cr. 8vo. 6s.
DIVERS VANITIES. Cr. 8vo. 6s.
Nesbit (E.), (Mrs. E. Bland), **THE RED HOUSE.** Illustrated. *Fourth Edition.* Cr. 8vo. 6s.
 See also Shilling Novels.
Norris (W. E.), HARRY AND URSULA. *Second Edition.* Cr. 8vo. 6s.
Ollivant (Alfred), OWD BOB, THE GREY DOG OF KENMUIR. *Tenth Edition.* Cr. 8vo. 6s.

- Oppenheim (E. Phillips).** MASTER OF MEN. *Fourth Edition.* Cr. 8vo. 6s.
- Ozenham (John),** Author of 'Barbe of Grand Bayou.' A WEAVER OF WEBS. *Second Edition.* Cr. 8vo. 6s.
- THE GATE OF THE DESERT.** *Fifth Edition.* Cr. 8vo. 6s.
- PROFIT AND LOSS.** With a Frontispiece in photogravure by HAROLD COPPING. *Fourth Edition.* Cr. 8vo. 6s.
- THE LONG ROAD.** With a Frontispiece by HAROLD COPPING. *Fourth Edition.* Cr. 8vo. 6s.
- Pain (Barry).** LINDLEY KAYS. *Third Edition.* Cr. 8vo. 6s.
- Parker (Gilbert).** PIERRE AND HIS PEOPLE. *Sixth Edition.* Cr. 8vo. 6s.
- MRS. FALCHION.** *Fifth Edition.* Cr. 8vo. 6s.
- THE TRANSLATION OF A SAVAGE.** *Third Edition.* Cr. 8vo. 6s.
- THE TRAIL OF THE SWORD.** Illustrated. *Ninth Edition.* Cr. 8vo. 6s.
- WHEN VALMOND CAME TO PONTIAC:** The Story of a Lost Napoleon. *Sixth Edition.* Cr. 8vo. 6s.
- AN ADVENTURER OF THE NORTH.** The Last Adventures of 'Pretty Pierre.' *Third Edition.* Cr. 8vo. 6s.
- THE SEATS OF THE MIGHTY.** Illustrated. *Fifteenth Edition.* Cr. 8vo. 6s.
- THE BATTLE OF THE STRONG:** a Romance of Two Kingdoms. Illustrated. *Fifth Edition.* Cr. 8vo. 6s.
- THE POMP OF THE LAVIETTES.** *Second Edition.* Cr. 8vo. 3s. 6d.
- Pemberton (Max).** THE FOOTSTEPS OF A THRONE. Illustrated. *Third Edition.* Cr. 8vo. 6s.
- I CROWN THEE KING.** With Illustrations by Frank Dadd and A. Forrester. Cr. 8vo. 6s.
- Phillipotts (Eden).** LYING PROPHETS. *Third Edition.* Cr. 8vo. 6s.
- CHILDREN OF THE MIST.** *Fifth Edition.* Cr. 8vo. 6s.
- THE HUMAN BOY.** With a Frontispiece. *Fourth Edition.* Cr. 8vo. 6s.
- SONS OF THE MORNING.** *Second Edition.* Cr. 8vo. 6s.
- THE RIVER.** *Third Edition.* Cr. 8vo. 6s.
- THE AMERICAN PRISONER.** *Fourth Edition.* Cr. 8vo. 6s.
- THE SECRET WOMAN.** *Fourth Edition.* Cr. 8vo. 6s.
- KNOCK AT A VENTURE.** With a Frontispiece. *Third Edition.* Cr. 8vo. 6s.
- THE PORTREEVE.** *Fourth Ed.* Cr. 8vo. 6s.
- THE POACHER'S WIFE.** *Second Edition.* Cr. 8vo. 6s.
- See also Shilling Novels.
- Pickthall (Marmaduke).** SAID THE FISHERMAN. *Sixth Ed.* Cr. 8vo. 6s.
- BRENDLE.** *Second Edition.* Cr. 8vo. 6s.
- THE HOUSE OF ISLAM.** *Third Edition.* Cr. 8vo. 6s.
- 'O,'** Author of 'Dead Man's Rock.' THE
- THE MAYOR OF TROY. *Fourth Edition.* Cr. 8vo. 6s.
- MERRY GARDEN AND OTHER STORIES.** Cr. 8vo. 6s.
- MAJOR VIGOUREUX.** *Second Edition.* Cr. 8vo. 6s.
- Rawson (Maud Stepney),** Author of 'A Lady of the Regency,' 'The Labourer's Comedy,' etc. THE ENCHANTED GARDEN. *Second Edition.* Cr. 8vo. 6s.
- Rhys (Grace).** THE WOOING OF SHEILA. *Second Edition.* Cr. 8vo. 6s.
- Ridge (W. Pett).** LOST PROPERTY. *Second Edition.* Cr. 8vo. 6s.
- ERB.** *Second Edition.* Cr. 8vo. 6s.
- A SON OF THE STATE.** *Second Edition.* Cr. 8vo. 3s. 6d.
- A BREAKER OF LAWS.** *A New Edition.* Cr. 8vo. 3s. 6d.
- MRS. GALER'S BUSINESS.** Illustrated. *Second Edition.* Cr. 8vo. 6s.
- SECRETARY TO BAYNE, M.P.** Cr. 8vo. 3s. 6d.
- THE WICKHAMSES.** *Fourth Edition.* Cr. 8vo. 6s.
- NAME OF GARLAND.** *Third Edition.* Cr. 8vo. 6s.
- Roberts (C. G. D.).** THE HEART OF THE ANCIENT WOOD. Cr. 8vo. 3s. 6d.
- Russell (W. Clark).** MY DANISH SWEETHEART. Illustrated. *Fifth Edition.* Cr. 8vo. 6s.
- HIS ISLAND PRINCESS.** Illustrated. *Second Edition.* Cr. 6vo. 6s.
- ABANDONED.** *Second Edition.* Cr. 8vo. 6s.
- See also Books for Boys and Girls.
- Sergeant (Adeline).** BARBARA'S MONEY. Cr. 8vo. 6s.
- THE PROGRESS OF RACHAEL.** Cr. 8vo. 6s.
- THE MYSTERY OF THE MOAT.** *Second Edition.* Cr. 8vo. 6s.
- THE COMING OF THE RANDOLPHS.** Cr. 8vo. 6s.
- See also Shilling Novels.
- Shannon (W.F.).** THE MESS DECK. Cr. 8vo. 3s. 6d.
- See also Shilling Novels.
- Shelley (Bertha).** ENDERBY. *Third Ed.* Cr. 8vo. 6s.
- Sidgwick (Mrs. Alfred),** Author of 'Cynthia's Way.' THE KINSMAN. With 8 Illustrations by C. E. Brock. *Third Ed.* Cr. 8vo. 6s.
- Sonnichsen (Albert).** DEEP-SEA VAGABONDS. Cr. 8vo. 6s.
- Sunbury (George).** THE H'APPENNY MILLIONAIRE. Cr. 8vo. 3s. 6d.
- Urquhart (M.).** A TRAGEDY IN COMMONPLACE. *Second Ed.* Cr. 8vo. 6s.
- Waineman (Paul).** THE SONG OF THE FOREST. Cr. 8vo. 6s.
- THE BAY OF LILACS.** *Second Edition.* Cr. 8vo. 6s.
- See also Shilling Novels.
- Waltz (E. C.).** THE ANCIENT LAND. MARK: A Kentucky Romance. Cr. 8vo.

Watson (H. B. Marriott). ALARMS AND EXCURSIONS. *Cr. 8vo. 6s.*
CAPTAIN FORTUNE. *Third Edition. Cr. 8vo. 6s.*
TWISTED EGLANTINE. With 8 Illustrations by FRANK CRAIG. *Third Edition. Cr. 8vo. 6s.*
THE HIGH TOBY. With a Frontispiece. *Third Edition. Cr. 8vo. 6s.*
A MIDSUMMER DAY'S DREAM. *Third Edition. Crown 8vo. 6s.*
 See also Shilling Novels.
Wells (H. G.). THE SEA LADY. *Cr. 8vo. 6s.*
Weyman (Stanley), Author of 'A Gentleman of France.' UNDER THE RED ROBE. With Illustrations by R. C. WOODVILLE. *Twenty-first Edition. Cr. 8vo. 6s.*
White (Stewart E.), Author of 'The Blazed Trail.' COLUJUROR'S HOUSE. A Romance of the Free Trail. *Second Edition. Cr. 8vo. 6s.*
White (Percy). THE SYSTEM. *Third Edition. Cr. 8vo. 6s.*
THE PATIENT MAN. *Second Edition. Cr. 8vo. 6s.*
Williams (Margery). THE BAR. *Cr. 8vo. 6s.*

Williamson (Mrs. C. N.), Author of 'The Barnstormers.' THE ADVENTURE OF PRINCESS SYLVIA. *Second Edition. Cr. 8vo. 6s.*
THE WOMAN WHO DARED. *Cr. 8vo. 6s.*
THE SEA COULD TELL. *Second Edition. Cr. 8vo. 6s.*
THE CASTLE OF THE SHADOWS. *Third Edition. Cr. 8vo. 6s.*
PAPA. *Cr. 8vo. 6s.*
Williamson (C. N. and A. M.). THE LIGHTNING CONDUCTOR: Being the Romance of a Motor Car. Illustrated. *Sixteenth Edition. Cr. 8vo. 6s.*
THE PRINCESS PASSES. Illustrated. *Eighth Edition. Cr. 8vo. 6s.*
MY FRIEND THE CHAUFFEUR. With 16 Illustrations. *Ninth Ed. Cr. 8vo. 6s.*
THE CAR OF DESTINY AND ITS ERRAND IN SPAIN. *Fourth Edition. Illustrated.*
LADY BETTY ACROSS THE WATER. *Ninth Edition. Cr. 8vo. 6s.*
THE BOTOR CHAPERON. *Fourth Ed. Cr. 8vo. 6s.*
Wyllarde (Dolf), Author of 'Uriah the Hittite.' THE PATHWAY OF THE PIONEER (Nous Autres). *Fourth Edition. Cr. 8vo. 6s.*

Methuen's Shilling Novels

Cr. 8vo. Cloth, 1s. net.

Author of 'Miss Molly.' THE GREAT RECONCILER.
Balfour (Andrew). VENGEANCE IS MINE.
Barling-Gould (S.). MRS. CURGENVEN OF CURGENVEN.
 DOMITIA.
 THE FROBISHERS.
 CHRIS OF ALL SORTS.
 DARTMOOR IDYLLS.
Barlow (Jane), Author of 'Irish Idylls.' FROM THE EAST UNTO THE WEST.
 A CREEL OF IRISH STORIES.
 THE FOUNDING OF FORTUNES.
 THE LAND OF THE SHAMROCK.
Barr (Robert). THE VICTORS.
Bartram (George). THIRTEEN EVENINGS.
Benson (E. F.), Author of 'Dodo.' THE CAPSINA.
Bowles (G. Stewart). A STRETCH OFF THE LAND.
Brooke (Emma). THE POET'S CHILD.
Bullock (Shan F.). THE BARRYS.
 THE CHARMER.
 THE SQUIREEN.
 THE RED LEAGUERS.
Burton (J. Bloundelle). THE CLASH OF ARMS.
 DENOUNCED.
 FORTUNE'S MY FOE.
 A BRANDED NAME.

Capes (Bernard). AT A WINTER'S FIRE.
Cheesey (Weatherby). THE BAPTIST RING.
 THE BRANDED PRINCE.
 THE FOUNDERED GALLEON.
 JOHN TOPP.
 THE MYSTERY OF A BUNGALOW.
Clifford (Mrs. W. K.). A FLASH OF SUMMER.
Cobb, Thomas. A CHANGE OF FACE.
Collingwood (Harry). THE DOCTOR OF THE 'JULIET.'
Cornford (L. Cope). SONS OF ADVERSITY.
Cotterell (Constance). THE VIRGIN AND THE SCALES.
Crane (Stephen). WOUNDS IN THE RAIN.
Denny (C. E.). THE ROMANCE OF UPFOLD MANOR.
Dickinson (Evelyn). THE SIN OF ANGELS.
Dickson (Harris). THE BLACK WOLF'S BREED.
Duncan (Sara J.). THE POOL IN THE DESERT.
 A VOYAGE OF CONSOLATION. Illustrated.
Embree (C. F.). A HEART OF FLAME. Illustrated.
Fenn (G. Manville). AN ELECTRIC SPARK.
 A DOUBLE KNOT.

- Findlater (Jane H.).** A DAUGHTER OF STRIFE.
Fitzstephen (G.). MORE KIN THAN KIND.
Fletcher (J. S.). DAVID MARCH. LUCIAN THE DREAMER.
Forrest (R. E.). THE SWORD OF AZRAEL.
Francis (M. E.). MISS ERIN.
Gallon (Tom). RICKERBY'S FOLLY.
Gerard (Dorothea). THINGS THAT HAVE HAPPENED.
THE CONQUEST OF LONDON.
THE SUPREME CRIME.
Gilchrist (R. Murray). WILLOWBRAKE.
Glanville (Ernest). THE DESPATCH RIDER.
THE KLOOF BRIDE.
THE INCA'S TREASURE.
Gordon (Julien). MRS. CLYDE. WORLD'S PEOPLE.
Goss (C. F.). THE REDEMPTION OF DAVID CORSON.
Gray (E. M'Queen). MY STEWARD-SHIP.
Hales (A. G.). JAIR THE APOSTATE.
Hamilton (Lord Ernest). MARY HAMILTON.
Harrison (Mrs. Burton). A PRINCESS OF THE HILLS. Illustrated.
Hooper (I.). THE SINGER OF MARLY.
Hough (Emerson). THE MISSISSIPPI BUBBLE.
'Iota' (Mrs. Caffyn). ANNE MAULERVERER.
Jepson (Edgar). THE KEEPERS OF THE PEOPLE.
Keary (C. F.). THE JOURNALIST.
Kelly (Florence Finch). WITH HOOPS OF STEEL.
Langbridge (V.) and Bourne (C. H.). THE VALLEY OF INHERITANCE.
Linden (Annie). A WOMAN OF SENTIMENT.
Lorimer (Norma). JOSIAH'S WIFE.
Lush (Charles K.). THE AUTOCRATS.
Macdonell (Anne). THE STORY OF TERESA.
Macgrath (Harold). THE PUPPET CROWN.
Mackie (Paulline Bradford). THE VOICE IN THE DESERT.
Marsh (Richard). THE SEEN AND THE UNSEEN.
GARNERED.
A METAMORPHOSIS.
MARVELS AND MYSTERIES.
BOTH SIDES OF THE VEIL.
Mayall (J. W.). THE CYNIC AND THE SYREN.
Meade (L. T.). RESURGAM.
Monkhouse (Allan). LOVE IN A LIFE.
Moore (Arthur). THE KNIGHT PUNCTILIOUS.
Nesbit, E. (Mrs. Bland). THE LITERARY SENSE.
Norris (W. E.). AN OCTAVE. MATTHEW AUSTIN. THE DESPOTIC LADY.
Oliphant (Mrs.). THE LADY'S WALK. SIR ROBERT'S FORTUNE. THE TWO MARYS.
Pendered (M. L.). AN ENGLISHMAN.
Penny (Mrs. Frank). A MIXED MARRIAGE.
Phillipotts (Eden). THE STRIKING HOURS. FANCY FREE.
Pryce (Richard). TIME AND THE WOMAN.
Randall (John). AUNT BETHIA'S BUTTON.
Raymond (Walter). FORTUNE'S DARING.
Rayner (Olive Pratt). ROSALBA.
Rhys (Grace). THE DIVERTED VILLAGER.
Rickert (Edith). OUT OF THE CYPRESS SWAMP.
Robertson (M. H.). A GALLANT QUAKER.
Russell, (W. Clark). ABANDONED.
Saunders (Marshall). ROSE À CHARLITTE.
Sergeant (Adeline). ACCUSED AND ACCUSER. BARBARA'S MONEY. THE ENTHUSIAST. A GREAT LADY. THE LOVE THAT OVERCAME. THE MASTER OF BEECHWOOD. UNDER SUSPICION. THE YELLOW DIAMOND. THE MYSTERY OF THE MOAT.
Shannon (W. F.). JIM TWELVES.
Stephens (R. N.). AN ENEMY OF THE KING.
Strain (E. H.). ELMSLIE'S DRAG NET.
Stringer (Arthur). THE SILVER POPPY.
Stuart (Esmé). CHRISTALLA. A WOMAN OF FORTY.
Sutherland (Duchess of). ONE HOUR AND THE NEXT.
Swan (Annie). LOVE GROWN COLD.
Swift (Benjamin). SORDON. SIREN CITY.
Tanqueray (Mrs. B. M.). THE ROYAL QUAKER.
Thompson (Vance). SPINNERS OF LIFE.
Trafford-Taunton (Mrs. E. W.). SILENT DOMINION.
Upward (Allen). ATHELSTANE FORD.
Waineman (Paul). A HEROINE FROM FINLAND.
BY A FINNISH LAKE.
Watson (H. B. Marriott). THE SKIRTS OF HAPPY CHANCE.
'Zack.' TALES OF DUNSTABLE WEIR.

Books for Boys and Girls

Illustrated. Crown 8vo. 3s. 6d.

- | | |
|---|--|
| <p>THE GETTING WELL OF DOROTHY. By Mrs. W. K. Clifford. <i>Second Edition.</i></p> <p>ONLY A GUARD-ROOM DOG. By Edith E. Cuthell.</p> <p>THE DOCTOR OF THE JULIET. By Harry Collingwood.</p> <p>LITTLE PETER. By Lucas Malet. <i>Second Edition.</i></p> <p>MASTER ROCKAFELLAR'S VOYAGE. By W. Clark Russell. <i>Third Edition.</i></p> <p>THE SECRET OF MADAME DE MONLUC. By the Author of "Mdle. Mori."</p> | <p>SYD BELTON ; Or, the Boy who would not go to Sea. By G. Manville Fenn.</p> <p>THE RED GRANGE. By Mrs. Molesworth.</p> <p>A GIRL OF THE PEOPLE. By L. T. Meade. <i>Second Edition.</i></p> <p>HEPSY GIPSY. By L. T. Meade. <i>2s. 6d.</i></p> <p>THE HONOURABLE MISS. By L. T. Meade. <i>Second Edition.</i></p> <p>THERE WAS ONCE A PRINCE. By Mrs. M. E. Mann.</p> <p>WHEN ARNOLD COMES HOME. By Mrs. M. E. Mann.</p> |
|---|--|

The Novels of Alexandre Dumas

Price 6d. Double Volumes, 1s.

- | | |
|--|---|
| <p>ACTÉ.</p> <p>THE ADVENTURES OF CAPTAIN PAMPHILE AMAURY.</p> <p>THE BIRD OF FATE.</p> <p>THE BLACK TULIP.</p> <p>THE CASTLE OF EPPSTEIN.</p> <p>CATHERINE BLUM.</p> <p>CECILE.</p> <p>THE CHEVALIER D'HARMENTAL. Double volume.</p> <p>CHICOT THE JESTER. Being the first part of <i>The Lady of Monsereau.</i></p> <p>CONSCIENCE.</p> <p>THE CONVICT'S SON.</p> <p>THE CURSIAN BROTHERS ; and OTHO THE ARCHER.</p> <p>CROP-EARED JACQUOT.</p> <p>THE FENCING MASTER.</p> <p>FERNANDE.</p> <p>GABRIEL LAMBERT.</p> <p>GEORGES.</p> <p>THE GREAT MASSACRE. Being the first part of <i>Queen Margot.</i></p> <p>HENRI DE NAVARRE. Being the second part of <i>Queen Margot.</i></p> | <p>HÉLÈNE DE CHAVERNY. Being the first part of the Regent's Daughter.</p> <p>LOUISE DE LA VALLIÈRE. Being the first part of <i>THE VICOMTE DE BRAGELONNE.</i> Double Volume.</p> <p>MAÎTRE ADAM.</p> <p>THE MAN IN THE IRON MASK. Being the second part of <i>THE VICOMTE DE BRAGELONNE.</i> Double volume.</p> <p>THE MOUTH OF HELL.</p> <p>NANON. Double volume.</p> <p>PAULINE ; PASCAL BRUNO ; and BONTEKOR.</p> <p>PÈRE LA RUINE.</p> <p>THE PRINCE OF THIEVES.</p> <p>THE REMINISCENCES OF ANTONY.</p> <p>ROBIN HOOD.</p> <p>THE SNOWBALL and SULTANETTA.</p> <p>SYLVANDIRE.</p> <p>TALES OF THE SUPERNATURAL.</p> <p>THE THREE MUSKETEERS. With a long Introduction by Andrew Lang. Double volume.</p> <p>TWENTY YEARS AFTER. Double volume.</p> <p>THE WILD DUCK SHOOTER.</p> <p>THE WOLF-LEADER.</p> |
|--|---|

Methuen's Sixpenny Books

- | | |
|---|---|
| <p>Albanesi (E. M.). LOVE AND LOUISA.</p> <p>Austen (Jane). PRIDE AND PREJUDICE.</p> <p>Bagot (Richard). A ROMAN MYSTERY.</p> <p>Balfour (Andrew). BY STROKE OF SWORD.</p> <p>Baring-Gould (S.). FURZE BLOOM.</p> <p>CHEAP JACK ZITA.</p> <p>KITTY ALONE.</p> <p>URITH.</p> <p>THE BROOM SQUIRE.</p> <p>IN THE ROAR OF THE SEA.</p> <p>NOËMI.</p> <p>A BOOK OF FAIRY TALES. Illustrated.</p> <p>LITTLE TU'PENNY.</p> <p>THE FROBISHERS.</p> <p>WINEFRED.</p> <p>Barr (Robert). JENNIE BAXTER, JOURNALIST.</p> <p>IN THE MIDST OF ALARMS.</p> <p>THE COUNTESS TEKLA.</p> | <p>THE MUTABLE MANY.</p> <p>Benson (E. F.). DODO.</p> <p>Brontë (Charlotte). SHIRLEY.</p> <p>Brownell (C. L.). THE HEART OF JAPAN.</p> <p>Burton (J. Bloundelle). ACROSS THE SALT SEAS.</p> <p>Caffyn (Mrs.), ('Iota'). ANNE MAULVERER.</p> <p>Capes (Bernard). THE LAKE OF WINE.</p> <p>Clifford (Mrs. W. K.). A FLASH OF SUMMER.</p> <p>MRS. KEITH'S CRIME.</p> <p>Corbett (Julian). A BUSINESS IN GREAT WATERS.</p> <p>Croker (Mrs. B. M.). PEGGY OF THE BARTONS.</p> <p>A STATE SECRET.</p> |
|---|---|

- ANGEL.
JOHANNA.
Dante (Alighieri). THE VISION OF DANTE (Cary).
Doyle (A. Conan). ROUND THE RED LAMP.
Duncan (Sara Jeannette). A VOYAGE OF CONSOLATION.
 THOSE DELIGHTFUL AMERICANS.
Elliot (George). THE MILL ON THE FLOSS.
Findlater (Jane H.). THE GREEN GRAVES OF BALGOWRIE.
Gallon (Tom). RICKERBY'S FOLLY.
Gaskell (Mrs.). CRANFORD.
 MARY BARTON.
 NORTH AND SOUTH.
Gerard (Dorothea). HOLY MATRIMONY.
 THE CONQUEST OF LONDON.
 MADE OF MONEY.
Gissing (George). THE TOWN TRAVELLER.
 THE CROWN OF LIFE.
Glanville (Ernest). THE INCA'S TREASURE.
 THE KLOOF BRIDE.
Gleig (Charles). BUNTER'S CRUISE.
Grimm (The Brothers). GRIMM'S FAIRY TALES. Illustrated.
Hope (Anthony). A MAN OF MARK.
 A CHANGE OF AIR.
 THE CHRONICLES OF COUNT ANTONIO.
 PHROSO.
 THE DOLLY DIALOGUES.
Hornung (E. W.). DEAD MEN TELL NO TALES.
Ingraham (J. H.). THE THRONE OF DAVID.
Le Queux (W.). THE HUNCHBACK OF WESTMINSTER.
Lovett-Yeats (S. K.). THE TRAITOR'S WAY.
Linton (E. Lynn). THE TRUE HISTORY OF JOSHUA DAVIDSON.
Lyall (Edna). DERRICK VAUGHAN.
Malet (Lucas). THE CARISSIMA.
 A COUNSEL OF PERFECTION.
Mann (Mrs. M. E.). MRS. PETER HOWARD.
 A LOST ESTATE.
 THE CEDAR STAR.
 ONE ANOTHER'S BURDENS.
Marchmont (A. W.). MISER HOAD.
 MORTIMER.
Moreland (John). PETER SIMPLE.
Mursh (Richard). THE WICKENHAM PEERAGE.
 THE GODDESS.
- THE JOSS.
 A METAMORPHOSIS.
Mason (A. E. W.). CLEMENTINA.
Mathers (Helen). HONEY.
GRIFF OF GRIFFITHSCOURT.
 SAM'S SWEETHEART.
Meads (Mrs. L. T.). DRIFT.
Mitford (Bertram). THE SIGN OF THE SPIDER.
Montresor (F. F.). THE ALIEN.
Morrison (Arthur). THE HOLE IN THE WALL.
Nesbit (E.). THE RED HOUSE.
Norris (W. E.). HIS GRACE.
 GILES INGLBY.
 THE CREDIT OF THE COUNTY.
 LORD LEONARD.
 MATTHEW AUSTIN.
 CLARISSA FURIOSA.
Oliphant (Mrs.). THE LADY'S WALK
 SIR ROBERT'S FORTUNE.
 THE PRODIGALS.
Oppenheim (E. Phillips). MASTER C MEN.
Parker (Gilbert). THE POMP OF THE LAVIETTES.
 WHEN VALMOND CAME TO PONTIA.
 THE TRAIL OF THE SWORD.
Pemberton (Max). THE FOOTSTEP OF A THRONE.
 I CROWN THEE KING.
Phillipotts (Eden). THE HUMAN BOY
 CHILDREN OF THE MIST.
 'O.' THE WHITE WOLF.
Ridge (W. Pett). A SON OF THE STATE
 LOST PROPERTY.
 GEORGE AND THE GENERAL.
Russell (W. Clark). A MARRIAGE A SEA.
 ABANDONED.
 MY DANISH SWEETHEART.
 HIS ISLAND PRINCESS.
Sergeant (Adeline) THE MASTER OF BEECHWOOD.
 BARBARA'S MONEY.
 THE YELLOW DIAMOND.
 THE LOVE THAT OVERCAME.
Surtees (R. S.). HANDLEY CROSS
 Illustrated.
 MR. SPONGE'S SPORTING TOUR
 Illustrated.
 ASK MAMMA. Illustrated.
Walford (Mrs. L. B.). MR. SMITH.
 COUSINS.
 THE BABY'S GRANDMOTHER.
Wallace (General Lew). BEN-HUR.
 THE FAIR GOD.
Watson (H. B. Marriot). THE ADVISOR.
 TURERS.
Weekes (A. B.). PRISONERS OF WAR
White (Percy). A PASSIONATE PILGRIM.

11784

